













# REHAU WINDOW SYSTEM 190

TECHNICAL INFORMATION  
PROFILE PRINT

# REHAU WINDOW SYSTEM 190

## PROFILE PRINT

### Legend

	Color Black
	Color Clay
	Color Beige
	Color Bronze
	Color White
	Steel Galvanized
	Aluminium Anodized
	Random Color
	Foiled Variant
	Packing (Detail see Article List)
	Wall Thickness in Millimeters
	Manually Installed Gasket
	Right Hand Format
	Left Hand Format
$I_x$	Moment of Inertia Along X-Axis in $\text{cm}^4$
$I_y$	Moment of Inertia Along Y-Axis in $\text{cm}^4$
	
	A-Denotes Dimension in Inches
	B-Denotes Dimension in Millimeters
	Drill Jigs
*	Non-Standard

# REHAU WINDOW SYSTEM 190

## PROFILE PRINT

### Table of Contents

Legend .....	1
Frame with Nail Fin, 606004 .....	3
Frame without Nail Fin, 606024 .....	3
Frame with Stucco Fin, 606014 .....	4
Frame with Nail Fin and J-Channel, 201515 .....	5
Internally Glazed Frame with Nail Fin, 606074 .....	6
Picture Frame with Nail Fin, 399000 .....	7
T-Mullion, 601995 .....	8
Sill Sash, 606006 .....	9
Interlock Sash, 606005 .....	10
Jamb Sash, 606007 .....	11
Transom, 606008 .....	12
Internally Glazed Transom, 500002 .....	13
Standard Glazing Stop, 245504 .....	14
Picture Frame Glazing Stop, 601935 .....	14
Monolithic Glazing Stop, 500012 .....	14
Standard Setting Block, 604368 .....	14
Fixed-Lite Setting Block, 604367 .....	14
Slider Track, 606009 .....	15
Sash Stop, 601985 .....	15
Frame Close-Out, 500124 .....	15
H-Mullion, 601975 .....	16
Attachment Bracket, 500236 .....	16
Chambered Mullion Cover, 619845 .....	17
Wide Frame Connector, 600226 .....	17
Flush Frame Connector, 600216 .....	17
Drain Cover Cap, 600526 .....	17
REHAU uPVC Polish, 252280 .....	18
Reinforcement, 399007 .....	19
Reinforcement, 399006 .....	19
Reinforcement, 500125 .....	19
Reinforcement, 399001 .....	19
Reinforcement, 255245 .....	20
Reinforcement, 245334 .....	20

# REHAU WINDOW SYSTEM 190

## PROFILE PRINT

### Frame Profile

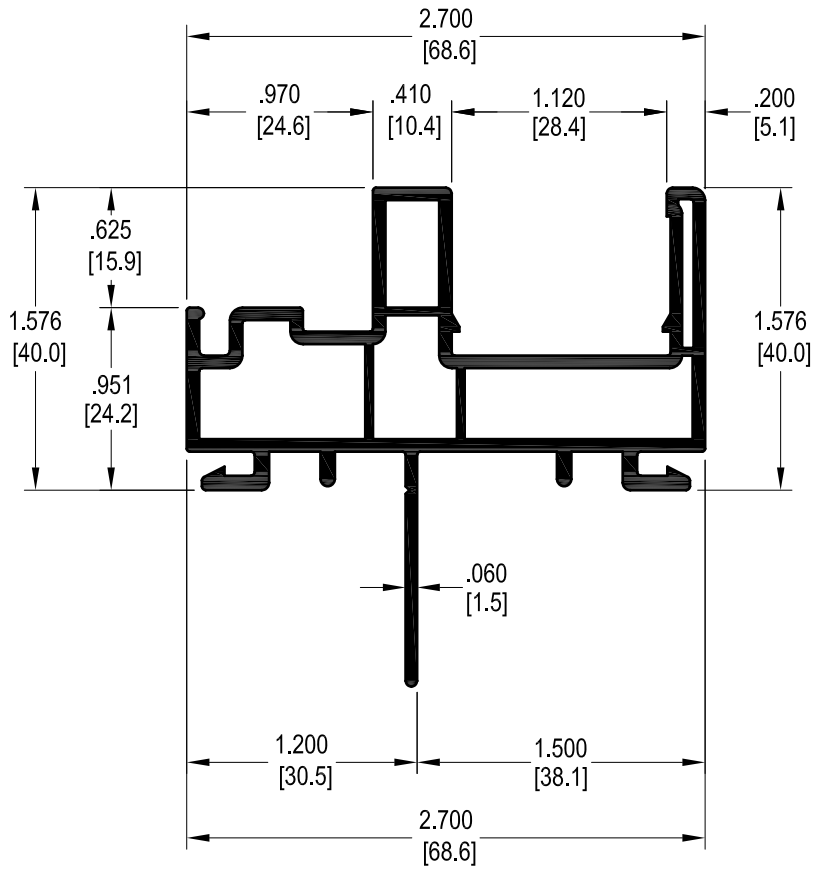

#### Frame with Nail Fin

<b>606004</b>	WHT	BG	CLAY
	RACK	RACK	RACK
	---	---	---
	PACK	PACK	PACK

#### 30.4 mm x 6.3 mm

	255245
	0.079 in (2.0 mm)
$I_x$	Relative to steel 0.0053 in <sup>4</sup> (0.22 cm <sup>4</sup> )
$I_y$	Relative to steel 0.0002 in <sup>4</sup> (0.01 cm <sup>4</sup> )
	PACK

Reinforcement is only needed for colors and for mulling frames

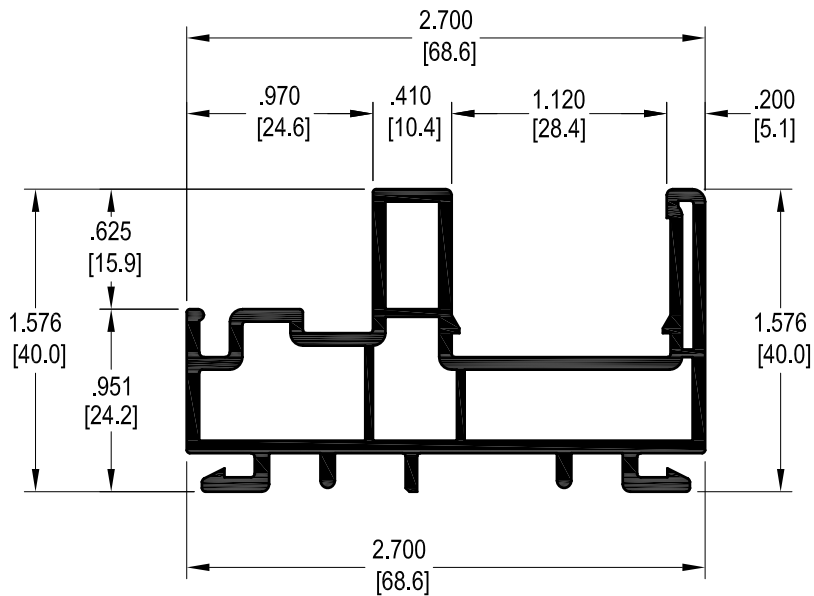
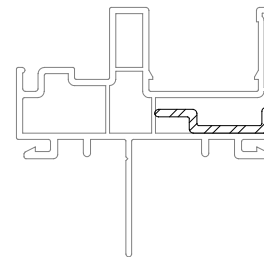

#### Frame without Nail Fin

<b>606024</b>	WHT	BG	CLAY
	RACK	---	---
	---	---	---
	PACK	---	---

#### 30.4 mm x 6.3 mm

	255245
	0.079 in (2.0 mm)
$I_x$	Relative to steel 0.0053 in <sup>4</sup> (0.22 cm <sup>4</sup> )
$I_y$	Relative to steel 0.0002 in <sup>4</sup> (0.01 cm <sup>4</sup> )
	PACK

Reinforcement is only needed for colors and for mulling frames

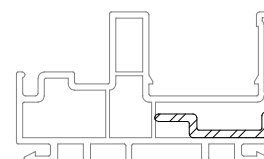

# REHAU WINDOW SYSTEM 190

## PROFILE PRINT

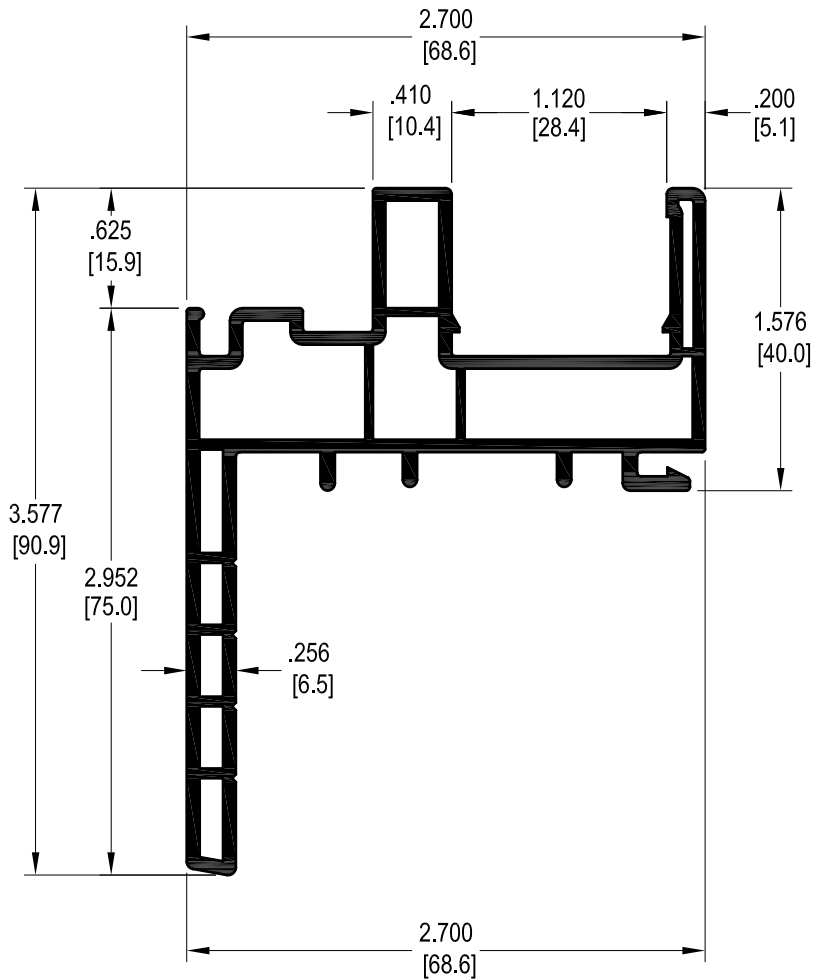

Frame Profile



Frame with Stucco Fin

<b>606014</b>	WHT	BG	CLAY
	RACK	---	---
	---	---	---
	PACK	PACK	PACK

30.4 mm x 6.3 mm

	255245
	0.079 in (2.0 mm)
$I_x$	Relative to steel 0.0053 in <sup>4</sup> (0.22 cm <sup>4</sup> )
$I_y$	Relative to steel 0.0002 in <sup>4</sup> (0.01 cm <sup>4</sup> )
	PACK

Reinforcement is only needed for colors and for mulling frames

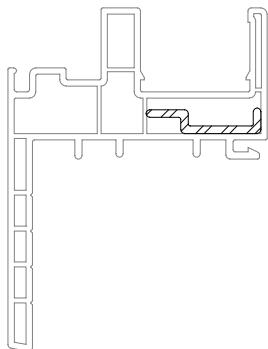

# REHAU WINDOW SYSTEM 190

## PROFILE PRINT

Frame Profile

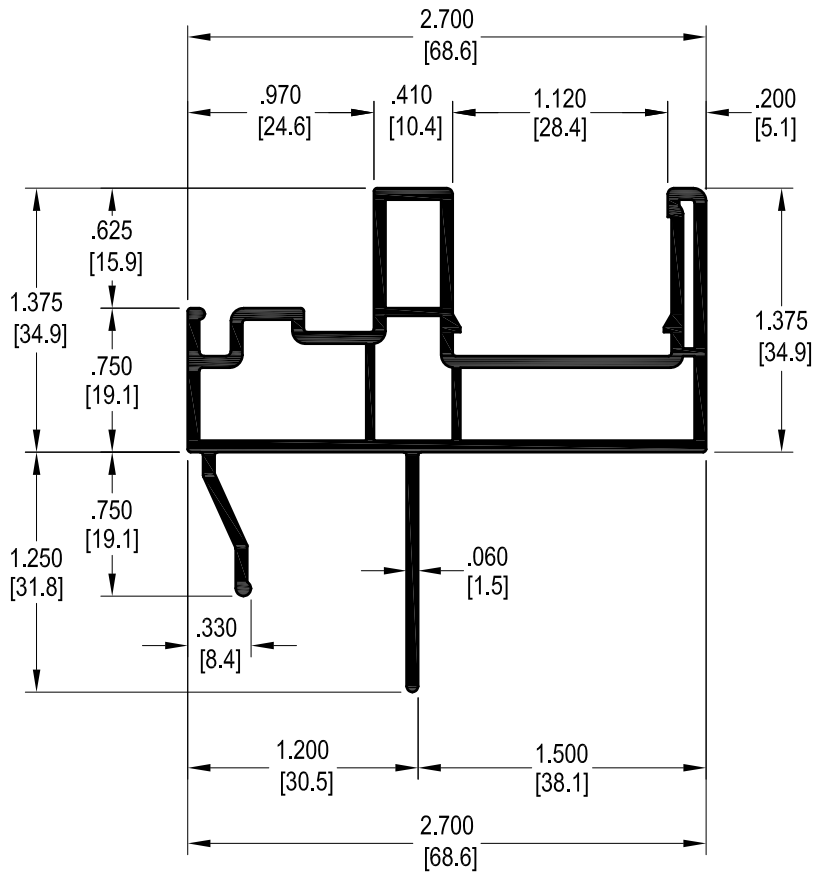



Frame with Nail Fin and J-Channel

201515 WHT BG CLAY

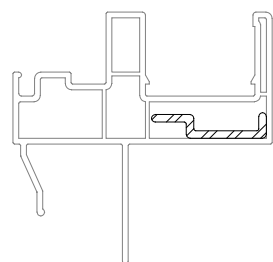
	RACK	RACK	---
	---	---	---
	PACK	PACK	---



30.4 mm x 6.3 mm

	255245
	0.079 in (2.0 mm)
$I_x$	Relative to steel 0.0053 in <sup>4</sup> (0.22 cm <sup>4</sup> )
$I_y$	Relative to steel 0.0002 in <sup>4</sup> (0.01 cm <sup>4</sup> )
	PACK

Reinforcement is only needed for colors and for mulling frames

# REHAU WINDOW SYSTEM 190

## PROFILE PRINT

Frame Profile

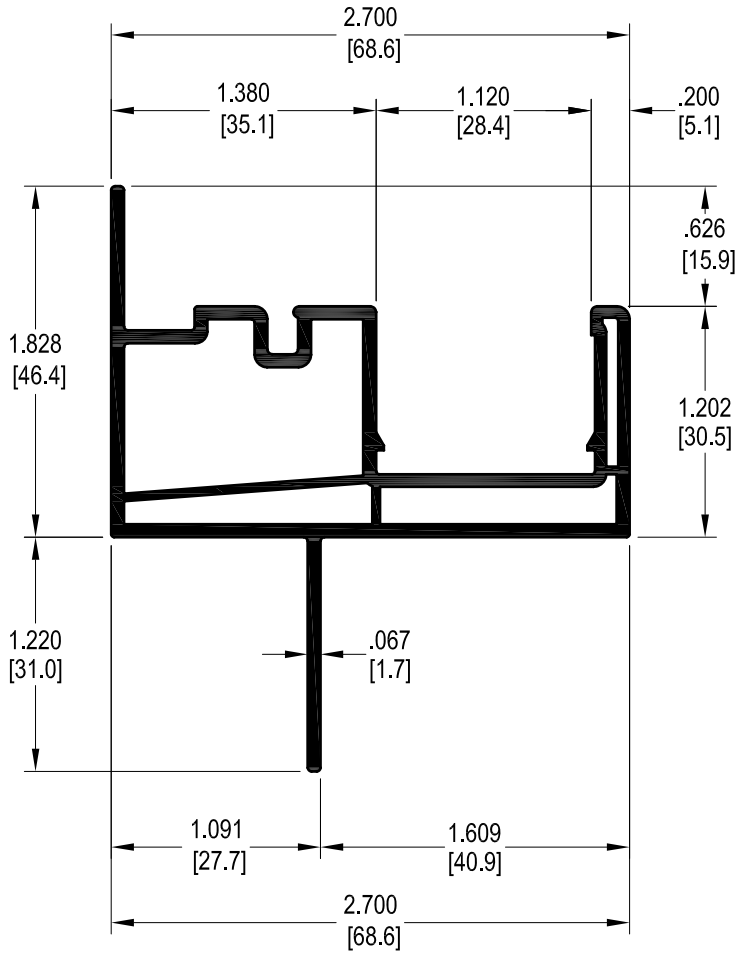

Internally Glazed Frame with Nail Fin

<b>606074</b>	WHT	BG	CLAY
	RACK	RACK	RACK
	---	---	---
	PACK	PACK	PACK

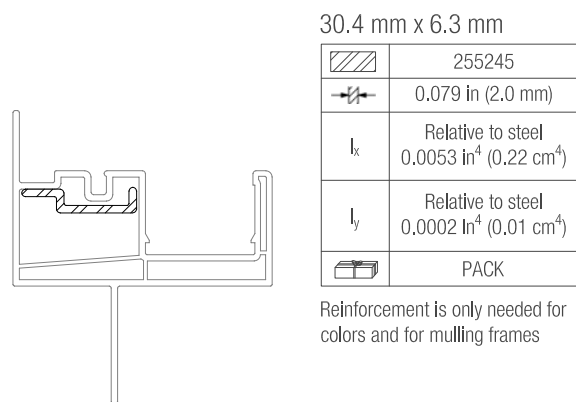

# REHAU WINDOW SYSTEM 190

## PROFILE PRINT

Frame Profile

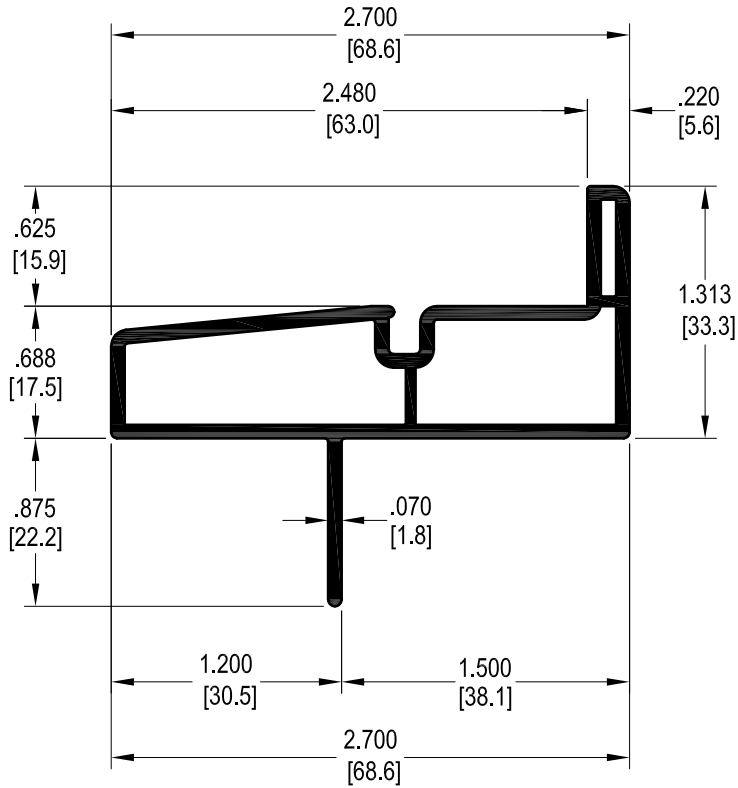

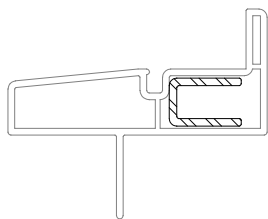

Picture Frame with Nail Fin

<b>399000</b>	WHT	BG	CLAY
	RACK	---	---
	---	---	---
	PACK	PACK	PACK



12.7 mm x 19.1 mm

	399007
	0.079 in (2.0 mm)
$I_x$	Relative to steel 0.0026 in <sup>4</sup> (0.11 cm <sup>4</sup> )
$I_y$	Relative to steel 0.0019 in <sup>4</sup> (0.08 cm <sup>4</sup> )
	PACK

Reinforcement is only needed for colors and for mulling frames



# REHAU WINDOW SYSTEM 190

## PROFILE PRINT

### Mullion Profile

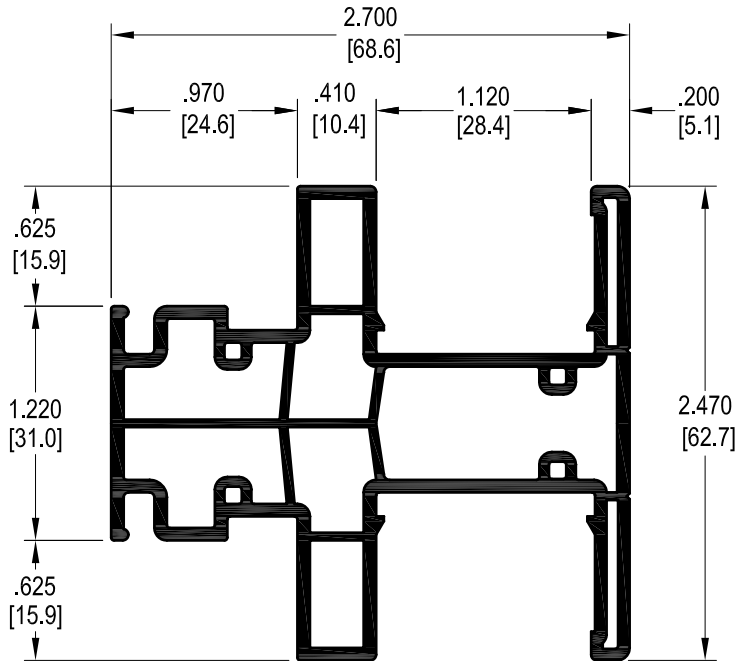

T-Mullion

601995

WHT

BG

CLAY



PACK

PACK

PACK

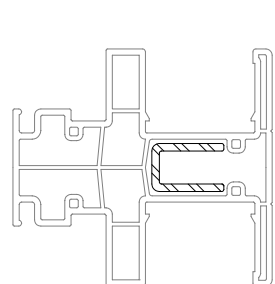

12.7 mm x 19.1 mm

	399007
	0.079 in (2.0 mm)
$I_x$	Relative to steel 0.0026 in <sup>4</sup> (0.11 cm <sup>4</sup> )
$I_y$	Relative to steel 0.0018 in <sup>4</sup> (0.08 cm <sup>4</sup> )
	PACK

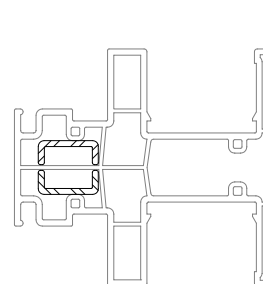

15.9 mm x 6.6 mm

	399001 x 2
	0.062 in (1.6 mm)
$I_x$	Relative to steel 0.0020 in <sup>4</sup> (0.08 cm <sup>4</sup> )
$I_y$	Relative to steel 0.0002 in <sup>4</sup> (0.01 cm <sup>4</sup> )
	PACK

# REHAU WINDOW SYSTEM 190

## PROFILE PRINT

Sash Profiles

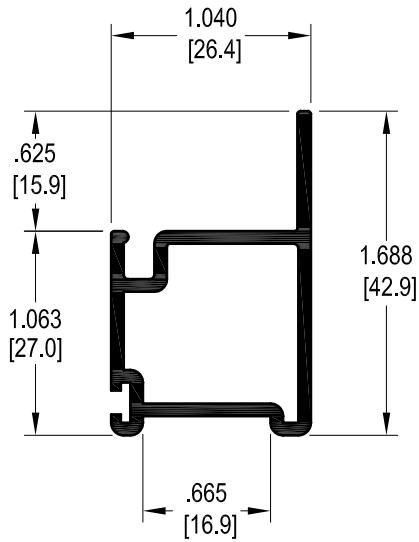



Sill Sash

<b>606006</b>	WHT	BG	CLAY
	RACK	RACK	RACK
	---	---	---
	PACK	PACK	PACK

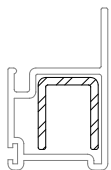
15.9 mm x 19.1 mm



	399006
	0.079 in (2.0 mm)
$I_x$	Relative to steel 0.031 in <sup>4</sup> (0.13 cm <sup>4</sup> )
$I_y$	Relative to steel 0.029 in <sup>4</sup> (0.12 cm <sup>4</sup> )
	PACK

# REHAU WINDOW SYSTEM 190

## PROFILE PRINT

### Sash Profiles

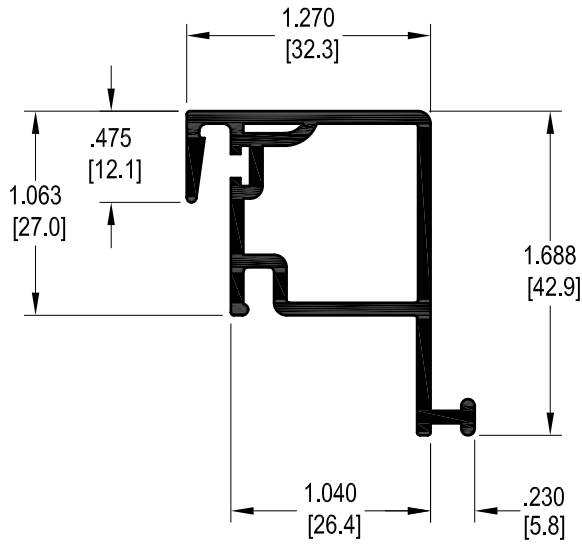



### Interlock Sash

<b>606005</b>	WHT	BG	CLAY
	RACK	RACK	RACK
	---	---	---
	PACK	PACK	PACK

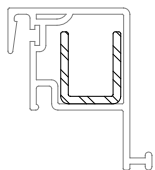
15.9 mm x 19.1 mm



	399006
	0.079 in (2.0 mm)
$I_x$	Relative to steel 0.031 in <sup>4</sup> (0.13 cm <sup>4</sup> )
$I_y$	Relative to steel 0.029 in <sup>4</sup> (0.12 cm <sup>4</sup> )
	PACK

# REHAU WINDOW SYSTEM 190

## PROFILE PRINT

### Sash Profiles

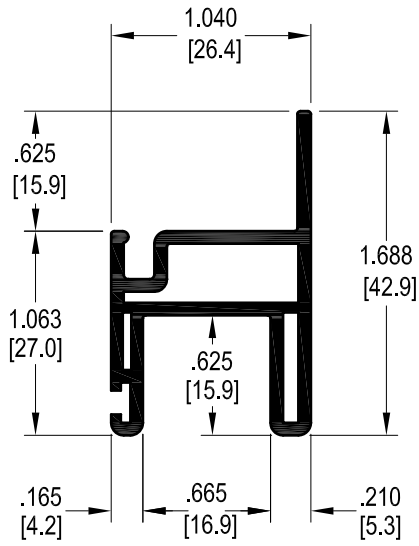

### Jamb Sash

<b>606007</b>	WHT	BG	CLAY
	RACK	RACK	RACK
	---	---	---
	PACK	PACK	PACK

15.9 mm x 6.6 mm

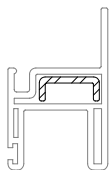

	399001
	0.062 in (1.6 mm)
$I_k$	Relative to steel 0.001 in <sup>4</sup> (0.04 cm <sup>4</sup> )
$I_y$	Relative to steel 0.0001 in <sup>4</sup> (0.004 cm <sup>4</sup> )
	PACK

# REHAU WINDOW SYSTEM 190

## PROFILE PRINT

Transom Profiles

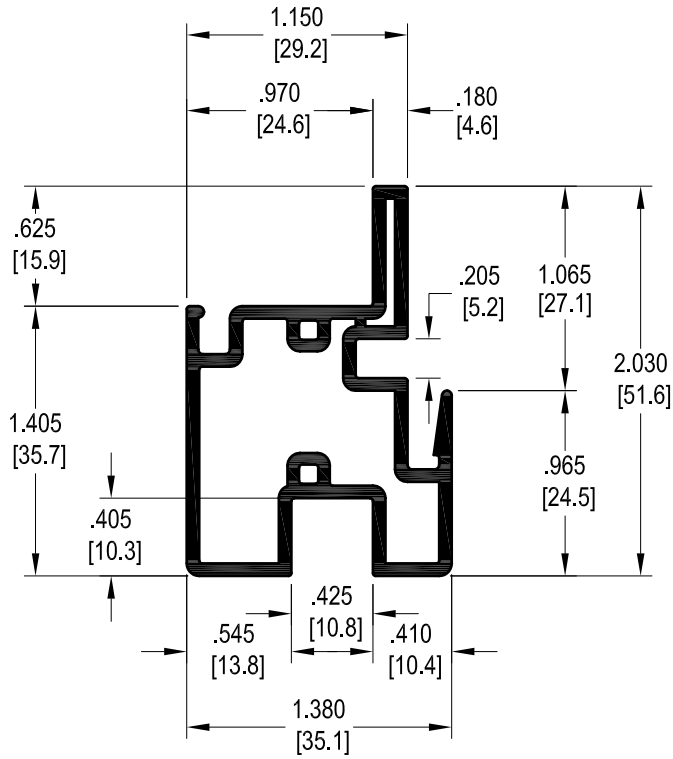

Transom

<b>606008</b>	WHT	BG	CLAY
	RACK	RACK	RACK
	---	---	---
	PACK	PACK	PACK

24.9 mm x 31.4 mm

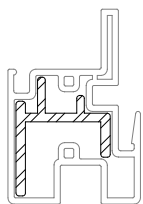

	500125
	0.098 in (2.5 mm)
$I_x$	Relative to steel 0.011 in <sup>4</sup> (0.45 cm <sup>4</sup> )
$I_y$	Relative to steel 0.005 in <sup>4</sup> (0.22 cm <sup>4</sup> )
	PACK

# REHAU WINDOW SYSTEM 190

## PROFILE PRINT

Transom Profiles

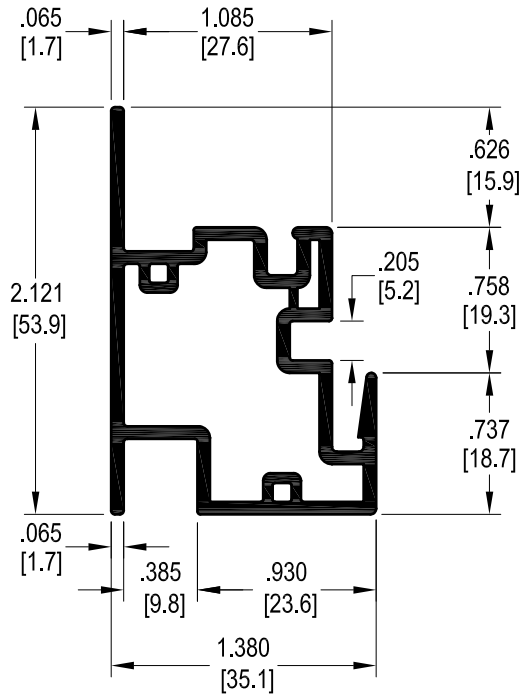



Internally Glazed Transom

<b>500002</b>	<b>WHT</b>	<b>BG</b>	<b>CLAY</b>
	---	---	---
	PACK	PACK	---

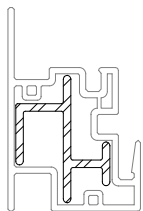
24.9 mm x 33.7 mm



	245334
	0.079 in (2.0 mm)
$I_x$	Relative to steel 0.045 in <sup>4</sup> (0.19 cm <sup>4</sup> )
$I_y$	Relative to steel 0.011 in <sup>4</sup> (0.45 cm <sup>4</sup> )
	PACK

# REHAU WINDOW SYSTEM 190

## PROFILE PRINT

### Glazing Stops / Setting Blocks

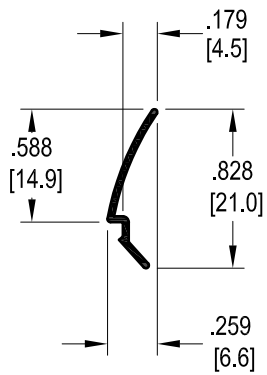

Standard Glazing Stop

**245504** [WHT] [BG] [CLAY]



--- --- ---  
PACK PACK PACK

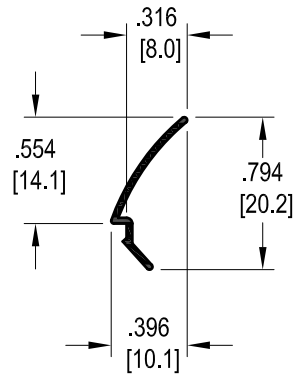

Picture Frame Glazing Stop

**601935** [WHT] [BG] [CLAY]



--- --- ---  
PACK PACK PACK

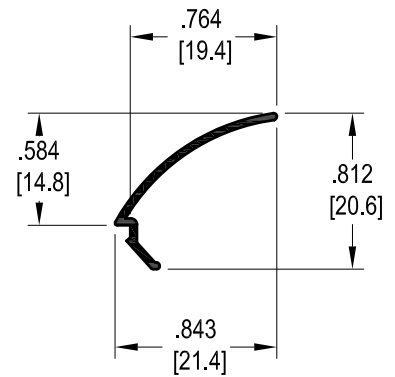

Monolithic Glazing Stop

**500012** [WHT] [BG] [CLAY]



--- --- ---  
PACK --- ---

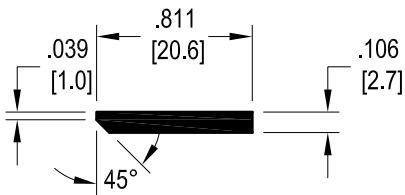

Standard Setting Block

**604368** [WHT] [BG] [CLAY]



--- --- ---  
PACK --- ---

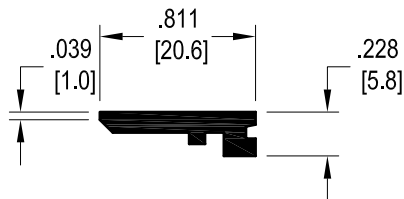

Fixed-Lite Setting Block

**604367** [WHT] [BG] [CLAY]



--- --- ---  
PACK --- ---

# REHAU WINDOW SYSTEM 190

## PROFILE PRINT

### Supplementary Profiles

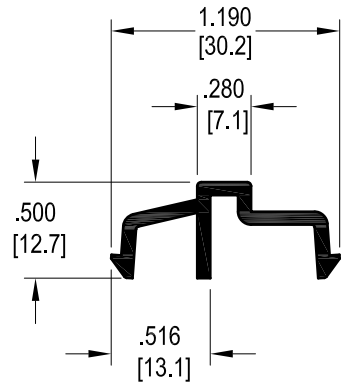

#### Slider Track

<b>606009</b>	<input type="checkbox"/> WHT	<input type="checkbox"/> BG	<input checked="" type="checkbox"/> CLAY
	RACK	---	---
	---	---	---
	PACK	PACK	PACK

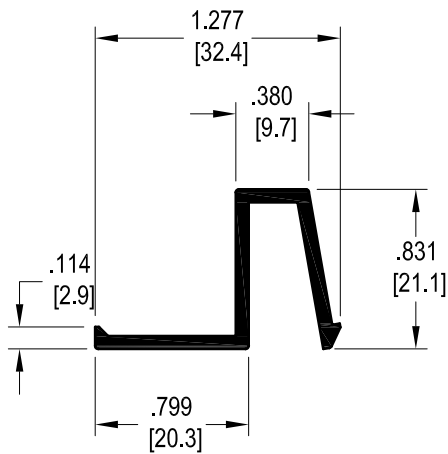

#### Sash Stop

<b>601985</b>	<input type="checkbox"/> WHT	<input type="checkbox"/> BG	<input checked="" type="checkbox"/> CLAY
	---	---	---
	---	---	---
	PACK	PACK	PACK

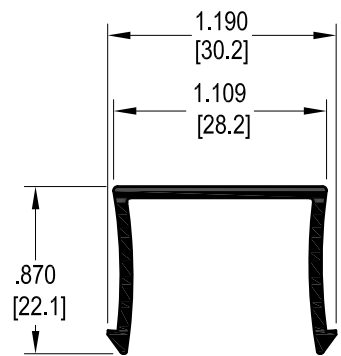

#### Frame Close-Out

<b>500124</b>	<input type="checkbox"/> WHT	<input type="checkbox"/> BG	<input checked="" type="checkbox"/> CLAY
	---	---	---
	---	---	---
	PACK	PACK	PACK



# REHAU WINDOW SYSTEM 190

## PROFILE PRINT

H-Mullion / Attachment Bracket

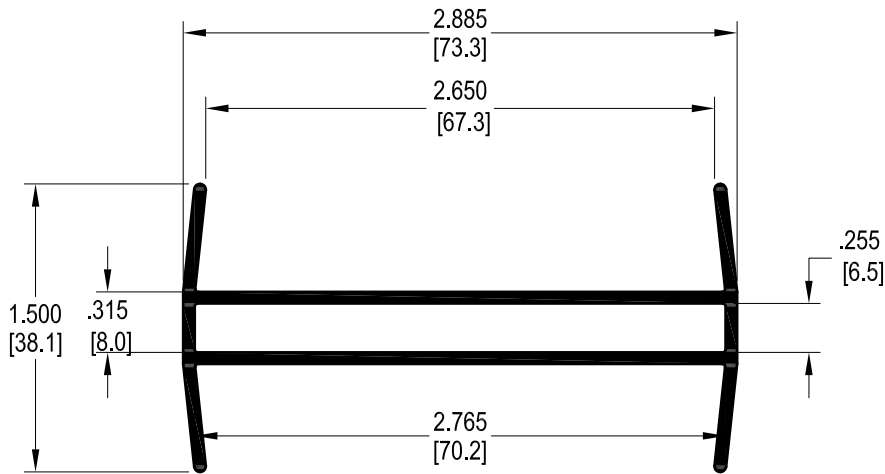

H-Mullion

601975 WHT BG CLAY

	---	---	---
PACK	---	---	---

63.5 mm x 6.4 mm

	*
	0.250 In (6.4 mm)
$I_x$	Relative to steel 0.1085 in <sup>4</sup> (4.52 cm <sup>4</sup> )
$I_y$	Relative to steel 0.0011 in <sup>4</sup> (0.05 cm <sup>4</sup> )
	PACK

\* Fabricator to purchase in local market

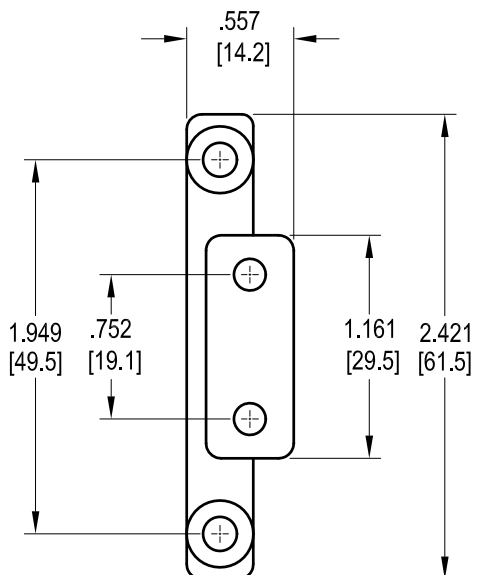
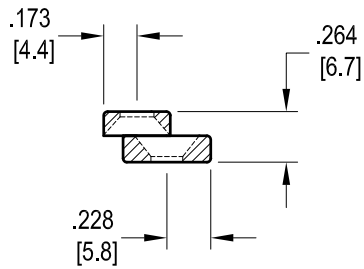
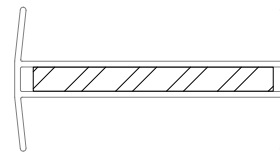

Attachment Bracket

500236 WHT BG CLAY

	---	---	---
PACK	PACK	PACK	---

# REHAU WINDOW SYSTEM 190

## PROFILE PRINT

Coupling Profiles / Accessories

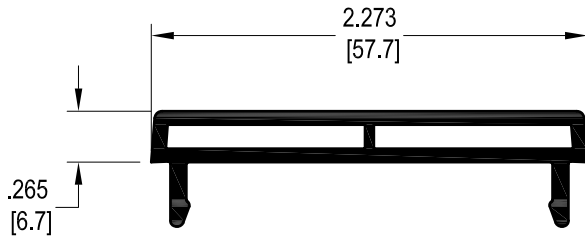

Chambered Mullion Cover

**619845** WHT BG CLAY



--- --- ---  
 --- --- ---  
 PACK\* PACK\* PACK\*

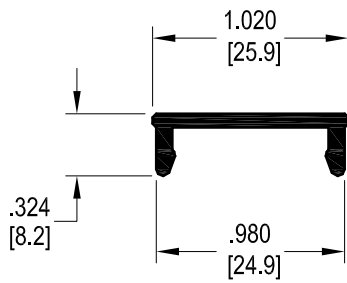

Wide Frame Connector

**600226** WHT BG CLAY



--- --- ---  
 --- --- ---  
 PACK PACK\* PACK

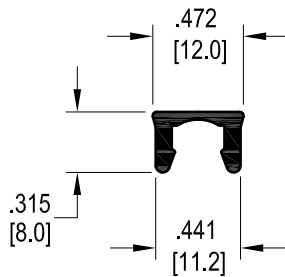

Flush Frame Connector

**600216** WHT BG CLAY



RACK\* --- ---  
 MOD\* --- ---  
 PACK PACK PACK\*



Drain Cover Cap

**600526** WHT BG CLAY



--- --- ---  
 --- --- ---  
 PACK PACK\* PACK\*

# REHAU WINDOW SYSTEM 190

## PROFILE PRINT

### Accessories



REHAU PVC Polish

252280 

 BOX\*

Please ask REHAU sales office for more information.

# REHAU WINDOW SYSTEM 190

## PROFILE PRINT

### Reinforcement Profiles

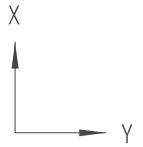

Aluminum Reinforcement Diagram	Thickness Art No.	Weight (kg/m)	Wind Load $I_x$ cm <sup>4</sup> (in <sup>4</sup> )	Glass Load $I_y$ cm <sup>4</sup> (in <sup>4</sup> )
	2.0 mm <b>399007</b>	0.25	0.11 (0.0026) (Relative to Steel)	0.08 (0.0018) (Relative to Steel)
	2.0 mm <b>399006</b>	0.26	0.13 (0.0031) (Relative to Steel)	0.12 (0.0029) (Relative to Steel)
	2.5 mm <b>500125</b>	0.44	0.45 (0.0108) (Relative to Steel)	0.22 (0.0054) (Relative to Steel)
	1.6 mm <b>399001</b>	0.11	0.04 (0.0010) (Relative to Steel)	0.004 (0.0001) (Relative to Steel)

# REHAU WINDOW SYSTEM 190

## PROFILE PRINT

### Reinforcement Profiles

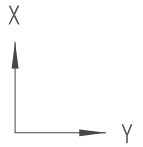

Reinforcement Diagram	Thickness Art No.	Weight (kg/m)	Wind Load $I_x$ cm <sup>4</sup> (in <sup>4</sup> )	Glass Load $I_y$ cm <sup>4</sup> (in <sup>4</sup> )
	2.0 mm <b>255245</b>	0.21	0.22 (0.0053) (Relative to Steel)	0.01 (0.0002) (Relative to Steel)
	2.0 mm <b>245334</b>	0.43	0.19 (0.0045) (Relative to Steel)	0.45 (0.0107) (Relative to Steel)

# REHAU WINDOW SYSTEM 190

## PROFILE PRINT

### Article List

Article Number	Description	Unit of Measure	Pack Qty	Rack Qty	Carton/Box Qty	Page
201515	Frame with Nail Fin and J-Channel	FT	83	2170		5
245334	Aluminum Reinforcement 24.9 mm x 33.7 mm x 2.0 mm	FT	520			13/20
245504	Standard Glazing Stop	FT	2000			14
255245	Aluminum Reinforcement 30.4 mm x 6.3 mm x 2.0 mm	FT	400			3/4/5/6/20
252280	REHAU uPVC Polish	PC			20	18
399000	Picture Frame with Nail Fin	FT	80	4320		7
399001	Aluminum Reinforcement 15.9 mm x 6.4 mm x 1.6 mm	FT	20			8/11/19
399006	Aluminum Reinforcement 15.9 mm x 19.1 mm x 2.0 mm	FT	20			9/10/19
399007	Aluminum Reinforcement 19.1 mm x 12.7 mm x 2.0 mm	FT	20			7/8/19
500002	Internally Glazed Transom	FT	34.8			13
500012	Monolithic Glazing Stop	FT	3800			14
500124	Frame Close-Out	FT	400			15
500125	Aluminum Reinforcement 24.9 mm x 31.4 mm x 2.5 mm	FT	20			12/19
500236	Attachment Bracket	PC	400			16
600216	Flush Frame Chambered	FT	1000	51000		17
600226	Wide Frame Connector	FT	1000	20000		17
600526	Drain Cover Cap	PC			1000	17
601935	Picture Frame Glazing Stop	FT	4800			14
601975	H-Mullion	FT	320			16
601985	Sash Stop	FT	400			15
601995	T-Mullion	FT	120			8
604367	Fixed-Lite Setting Block	PC	3000			14
604368	Standard Setting Block	PC	3000			14
606004	Frame with Nail Fin	FT	80	2400		3
606005	Interlock Sash	FT	160	7200		10
606006	Sill Sash	FT	160	9120		9
606007	Jamb Sash	FT	160	9200		11
606008	Transom	FT	160	4760		12
606009	Slider Track	FT	400	24000		15
606014	Frame with Stucco Fin	FT	80	2240		4
606024	Frame without Nail Fin	FT	80	2400		3
606074	Internally Glazed Frame with Nail Fin	FT	80	2400		6
619845	Chambered Mullion Cover	FT	160	7680		17

---

The information contained herein is believed to be reliable, but no representations, guarantees or warranties of any kind are made as to its accuracy, suitability for particular applications or the results to be obtained therefrom. Before using, the user will determine suitability of the information for user's intended use and shall assume all risk and liability in connection therewith.

© 2017 REHAU