



REHAU®

Unlimited Polymer Solutions



RAUVISIO BRILLIANT

Technical information

This 'RAUVISIO brilliant' technical information is valid from January 2019.

With the publication of this document, the previous versions are no longer valid.

Our current technical documentation is available for download at www.rehau.com/rauvisio.

This document is protected by copyright. The rights thus established, especially those to the translation, reprinting, excerpting of figures, radio transmissions, reproduction in photomechanical or similar ways or saving in data processing systems, are reserved.

All dimensions and weights are guide values. Subject to errors and modifications.

With the kind support of nobilia kitchens



CONTENT

1	Information and safety instructions	4
2	Product description	6
2.1	Product description	6
2.2	Single components	6
2.3	RAUVISIO brilliant composite pressed board	7
2.4	Finished component RAUVISIO brilliant complete	7
3	Transport, packaging and storage	8
3.1	Transport and loading information	8
3.2	Packaging	8
3.3	Internal transport and storage	9
4	Prerequisites for processing	10
4.1	Edgeband material	10
4.2	Processing individual laminates	10
4.2.1	Substrate	10
4.2.2	Adhesive	10
4.2.3	Balancing sheet	10
5	Before processing	11
5.1	Unpacking	11
5.2	Checking the boards or laminates	11
5.3	Conditioning	11
5.4	Documents for material warranty	11
6	Processing RAUVISIO brilliant	12
6.1	Proper handling of RAUVISIO boards	12
6.2	Preparing the individual laminates	12
6.2.1	Pre-treatment of the laminates and substrates	12
6.2.2	Manufacture of the pressed board	13
6.2.3	After processing the pressed board	13
6.3	Mechanical processing of the pressed board	13
6.4	Thermoforming of RAUVISIO brilliant	14
6.5	Edging	14
6.6	The edged component	14
7	Sealing, finish and spot repair	15
8	Technical data	16
9	Installation guidelines	20
10	Care and usage instructions for the end user	21

1 INFORMATION AND SAFETY INSTRUCTIONS

Validity

This Technical Information publication is valid worldwide.

Latest version of the Technical Information

To ensure your safety and proper use of our products, please regularly check whether a more recent version of the technical information is available.

You can obtain the latest version of the document from your specialist retailer, your REHAU sales office or you can download it at www.rehau.de/rauvisio-brilliant.

Navigation

At the beginning of this technical information, you will find a detailed table of contents with the hierarchical headings and corresponding page numbers.

Pictograms and logos



Safety instructions



Legal notice



Important information



Information on the internet



Your advantages

Intended use

RAUVISIO products may only be configured, installed and operated as described in this technical information. Any other use is deemed to be outside the intended scope of application.

Suitability of the material

Our valid Technical Information is to be observed for the processing / assembly and use of RAUVISIO brilliant. Our Technical Information is based on empirical values and knowledge acquired up to the time of printing. The dissemination of this information does not comprise any assurance of the properties of the products described. No explicit or implicit guarantee may be derived from it.

The information does not release the user/purchaser from its duty to properly and competently assess this material and its assembly as to their suitability for the respective conditions of the object and for the intended purposes.

Disclosure of information

It is essential to ensure that your customers, also including end customers, are aware of the necessity to observe the current Technical Information as well as instructions for care and use for RAUVISIO brilliant products.

The instructions for use and care must be provided to the end customer either by yourself or by your customer.

Note to our distribution partners and customers that press RAUVISIO acrylic laminates and resell the laminated boards: Please inform your customers of the need to follow the current Technical Information and make this available to them.

Note to processors of pressed acrylic laminate boards: Please ensure that at least the installation guidelines (chapter „9 Installation guidelines“) and the instructions for use and care (chapter „10 Care and usage instructions for the end user“) are made available to your customers and processing and installation firms.

Safety information and installation instructions

Observe the information on packaging, accessory parts and installation instructions. Keep the installation instructions handy for easy access.

If you do not understand the safety information or the individual installation procedures or if something is unclear, please contact your REHAU sales office.

Relevant regulations and safety equipment

All applicable safety and environmental regulations as well as the regulations of the trade supervisory centre and professional association must be strictly observed. These always take priority over the instructions and recommendations given in the Technical Information.

Always use safety equipment such as

- Gloves
- Protective goggles
- Ear protection
- Dust mask

Adhesives and additional tools

Strictly observe the safety instructions for any adhesives.

Always store work equipment such as alcohol-based cleaning products and other easily flammable materials in safe and well-ventilated places.

Ventilation/extraction, production dust

Ensure good ventilation and extraction around the processing machines.

If production dust is inhaled, provide fresh air and in the event of symptoms seek medical advice.

Protective measures and disposal

RAUVISIO brilliant is a coextruded material made from acrylic and styrene copolymer that is not harmful to the environment. The dust that forms is not toxic. The dust concentration is to be minimised through suitable protective measures such as suction or a dust mask.

Dust from RAUVISIO brilliant presents no specific risk of explosion.

Disposal code in accordance with the Waste Catalogue Ordinance:

- 170203/Construction and demolition waste consisting of wood, glass, plastic
- 120105/Waste from mechanical shaping processes and from the physical and mechanical surface treatment of metals and plastics (plastic shavings and lathe shavings)

Fire behaviour

Due to its composition of the main constituents acrylic and styrene copolymer, RAUVISIO brilliant demonstrates favourable fire behaviour and is categorised to DIN 4102-B2 as normal flame resistance. In case of fire, no toxic substances such as heavy metals or halogens are released. The same fire fighting techniques can be used as for construction materials containing wood.

Extinguishing fires

Suitable extinguishing agents for fire-fighting are

- Water spray
- Foam
- CO₂
- Extinguishing powder

A solid-stream water jet is unsuitable for safety reasons.

When extinguishing fires, wear appropriate protective clothing and, if necessary, a self-contained breathing apparatus.

2 PRODUCT DESCRIPTION

2.1 Product description

As an acrylic laminate, RAUVISIO brilliant represents the latest trends in furniture design and interior design. The seamless joining of boards and edges results in a flawless, high-gloss or matt component. Thanks to its brilliant depth effect, RAUVISIO brilliant replaces high quality paint elements when designing surfaces.



Fig. 2-1 RAUVISIO brilliant for high gloss surfaces

RAUVISIO brilliant has the following advantages:

	RAUVISIO brilliant	RAUVISIO brilliant SR
High-gloss	✓	✓
Matt		✓
Hygienic	✓	✓
Water-tight	✓	✓
Can be thermo-formed	✓	
Non-porous	✓	✓
Can be processed with conventional woodworking tools	✓	✓
High tension force	✓	✓
Surface marks can be repaired	✓	
High resistance to chemicals		✓
High scratch-resistance		✓
Production site monitoring, TÜV certification	✓ for RAUVISIO brilliant complete	✓ for RAUVISIO brilliant SR complete



2.2 Single components

All RAUVISIO brilliant components can be ordered separately:

RAUVISIO brilliant (high-gloss laminate)

RAUVISIO brilliant is a multi-layer coextruded polymer laminate produced from a styrene copolymer base layer and an acrylate top layer.

Due to the 0.7 – 0.8 mm thick material combination, RAUVISIO brilliant achieves a high tension force that has a positive effect on the surface smoothness and, in combination with a wooden substrate, creates a mirror gloss surface.

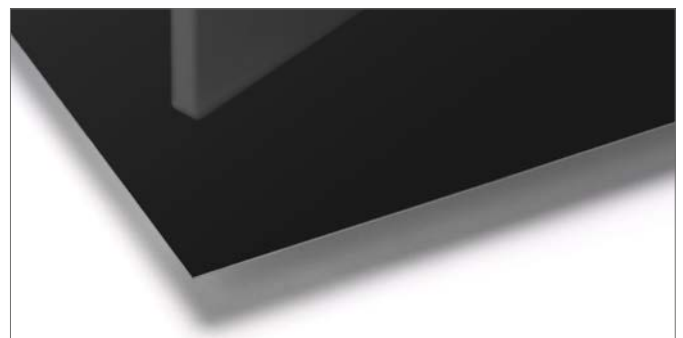

Fig. 2-2 High gloss laminate RAUVISIO brilliant in the colour moro

RAUVISIO brilliant SR (high-gloss laminate)

RAUVISIO brilliant SR (high-gloss laminate) is used in places where a high level of chemical and scratch resistance is required. This is achieved by means of a special hard coating.

RAUVISIO brilliant SR (matt laminate)

RAUVISIO brilliant SR (matt laminate) is a hard-coated matt variant which behaves like the high-gloss SR surface in terms of its properties. The only difference is the gloss level of the hard coating.

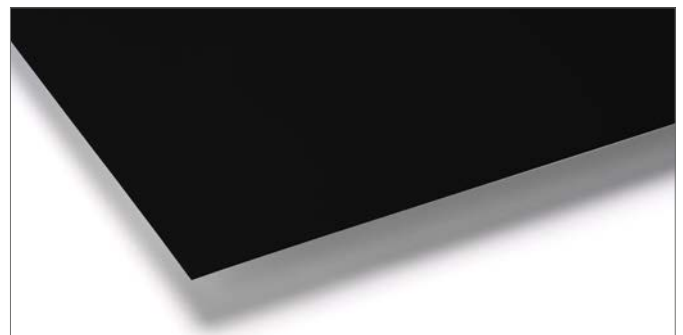

Fig. 2-3 Matt laminate RAUVISIO brilliant SR in the colour moro

Balancing sheet (embossed)

The specially developed balancing sheet is perfectly matched with the acrylic laminate. The material thickness of the balancing sheet of 0.7–0.8 mm ensures minimal warpage of the laminated board.

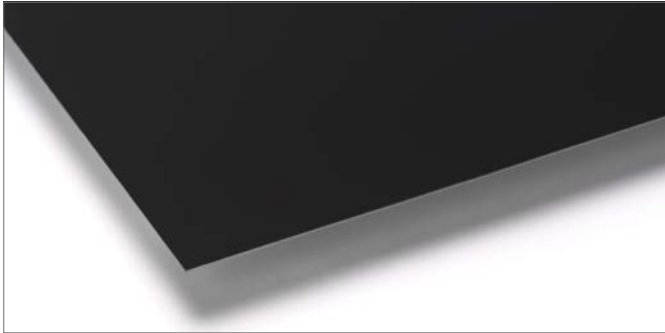

Fig. 2-4 RAUVISIO brilliant balancing sheet in the colour moro

Edgeband collection

Whether high-gloss or matt uni-edge, V-groove or 3D look – REHAU offers up to seven different edge design lines for RAUVISIO brilliant (SR) that leave nothing to be desired. In total there are more than 60 edge types available from stock, all perfectly colour-matched to the surface.

As usual with REHAU, all edges are available as RAUKANTEX pure, RAUKANTEX plus or RAUKANTEX pro.



Fig. 2-5 RAUVISIO brilliant edge collection in the colour moro

2.3 RAUVISIO brilliant composite pressed board

RAUVISIO brilliant is also available as a large pressed board (1300 x 2800 mm), consisting of acrylic laminate, MDF board and colour-matched balancing sheet.

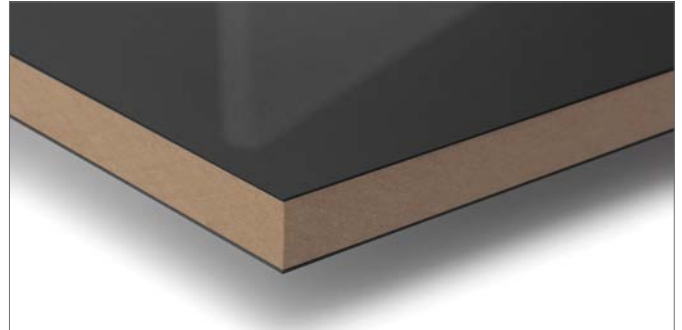

Fig. 2-6 RAUVISIO brilliant composite pressed board in the colour moro

2.4 Finished component RAUVISIO brilliant complete

Use the REHAU surface configurator to select RAUVISIO brilliant components and the matching edgebands and we'll deliver individually fabricated zero-joint fronts, or even one-offs.



Fig. 2-7 RAUVISIO brilliant completely finished component in the colour moro

3 TRANSPORT, PACKAGING AND STORAGE

3.1 Transport and loading information



Check the exterior packaging for damage immediately when the goods arrive:

- If damage has occurred, open the packaging in the presence of the freight carrier and record the damage to the goods.
- This must be confirmed by the haulier with their name, company, date and signature.
- The damage is to be reported to the freight carrier within 24 hours.

Otherwise the haulier's insurance company will not accept liability.

3.2 Packaging



Protect the boards with foam non-woven material.

With RAUVISIO brilliant the edges and surfaces must be protected. Particularly when moving, picking and further processing the boards, avoid or remove any dirt or foreign materials that may get between the individual boards. Otherwise the stack pressure/ dead weight of the boards will inevitably cause indentations in the laminate surfaces.

- Protect surfaces with foam mats.

This will prevent marks being caused on the surface when stacking components.

Transport

The boards must not be exposed to temperatures higher than 60 °C during transport to avoid thermal overloading of the adhesive/laminate system.

Exposure to extreme temperatures may lead to movement between the adhesive and acrylic laminate which can result in orange peel / distortion which will be detrimental to the mirror gloss finish.

Delivery

Boards are shipped loaded on square timber battens or pallets to ensure they are kept flat.

- Ideally packaging units should be unloaded with a forklift or similar mechanical equipment.
- If the appropriate lifting equipment is not available, the boards/ laminate can be unloaded by hand. If manually unloading, precautions must be taken to ensure the boards/ laminate are kept clean, and are not subjected to undue mechanical loads (twisting, folding bending, etc.).
- Suitable protective equipment such as gloves should be worn during manual handling, as sharp edges can cause cuts.
- The use of transport aids such as suction lifters, lift handles and board transporters is recommended for handling; see also chapter „5.1 Unpacking“.
- Bending is not permitted during lifting and movement of the RAUVISIO brilliant boards.

3.3 Internal transport and storage

Inter-company transport

While being moved RAUVISIO brilliant boards must be fully supported along their complete length, and kept as flat and level as possible. The ideal method is to transport them in the packing variant in which they were delivered (no repacking recommended).

Storage

RAUVISIO brilliant is supplied on pallets or square timber battens covered with appropriate protective boards. The packaging units with RAUVISIO brilliant are stackable. Due to the stack pressure, however, it is not permitted for more than five packaging units to be stored on top of one another.



Protecting packaging units (PU)

The packaging units are to be protected against damage, high temperature and humidity fluctuations as well as high UV levels of artificial lighting or direct sunlight.

Store the boards flat and level to the floor.

RAUVISIO brilliant must be kept flat, level and fully supported along its complete length.

It is recommended to store boards on the supplied pallet. Alternatively, boards must be supported by a minimum of 4 evenly spaced timber battens of equal size (see diagram). This will prevent bending or warping.

In the event of storage in conditions not in line with those described above (pallet or on at least 4 equal battens), no assurances can be given against warping.

The material must be stored in closed, heated rooms in which the room temperature is between 15 and 25 °C and the relative humidity is between 40 and 60%.

Before opening the packaging unit, the goods must have an acclimatisation period at room temperature of at least 48 hours or longer depending on the season.

Prior to returning opened or partially used packaging units to storage it must be ensured that the cover plate is replaced on top. This is to prevent contamination and uneven temperature/humidity penetration (due to drafts or heating air), and thus counteract warping effects as well as surface damage.

Storage before and after adhesion of the laminate

Prior to adhesion, all materials must be acclimatized for a sufficient period of time and therefore no longer have any temperature differences.

Storage immediately after gluing must take place in closed, heated rooms. Ensure that the storage temperature does not exceed 60 °C.

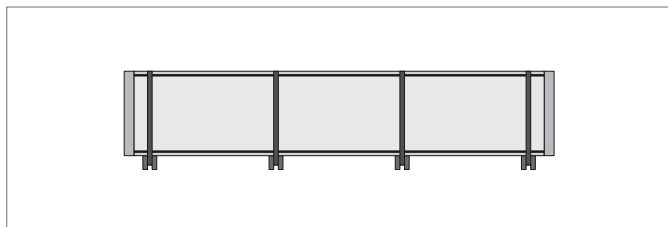

Fig. 3-1 Storage on 4 battens

4 PREREQUISITES FOR PROCESSING

4.1 Edgeband material

The use of a RAUKANTEX edgeband material is recommended to ensure continuity of appearance between the RAUVISIO brilliant surface and the edges. See chapter „6.5 Edging“.

4.2 Processing individual laminates

4.2.1 Substrate

Wooden substrates, lightweight boards or composite material substrates are considered for use as a substrate for RAUVISIO brilliant. In order to meet the high demands on the surface it is critical that the substrate is selected with the intended application in mind.

When choosing the substrate, adequate planarity must be ensured.

The surface structure of the substrate is critical for a good appearance. A fine surface structure is a prerequisite for an even high quality surface.

An MDF board is recommended as a substrate here. It has a very fine surface structure from which only very small fibres are pulled out during processing (sawing, milling, drilling, adhesion.) By comparison the quantity of fibres pulled out from a chipboard, OSB, or plywood panel is much greater leading to the chance that the unevenness will be visible through the laminate thereby "distorting" the surface. With chipboard, particles can drop out of the middle layer that then leave indentations in the laminate. This hazard does not arise when using an MDF substrate.



An MDF substrate is recommended for a high-quality surface finish.

4.2.2 Adhesive

In addition to selecting the suitable substrate, selection of the correct adhesive is important to ensure board quality. Single component PU hotmelts have become increasingly common in recent years. These adhesives can be easily applied to the board or substrate using rollers. A short press-down time is usually sufficient to ensure a high initial strength. Pressing with a continuous roller lamination system is recommended to ensure a high quality surface finish.

The hotmelt adhesives react with the humidity/moisture in the material and the temperature.

For secure, high-quality adhesion, the use of RAUVISIO Flat-Lam PUR is recommended.

With matt, non-gloss surfaces, good results have also been achieved with conventional ethylene vinyl acetate (EVA) dispersion adhesives using cycle presses. These should, however, be verified in the actual production conditions.

When using other adhesives please contact the adhesive manufacturer with regard to processing recommendations/guarantees.



Ensure sufficient adhesion/final adhesion strength.

An adhesion strength of approx. 80 % is achieved after just a few hours, the adhesive joint takes max. 7 days to achieve its final strength.

Checking bonds

For non standard applications bond strength should be independently checked and verified.

4.2.3 Balancing sheet

Ensuring a functional overall system that maintains dimensional stability under fluctuating temperature and moisture conditions requires a balancing sheet that guarantees stability under changing climatic conditions.

Generally a symmetrical composition is optimum when it comes to warpage. However, it is not always possible to create a symmetrical design. For this reason other materials may be used for the balancing sheet. Materials such as CPL (Continuous Pressing Laminates) or other polymeric materials may be used depending on application. Based on experience, the REHAU system is based on a symmetrical polymer structure and offering matched, finished components. This system is recommended for in-house pressing.

For non standard applications, such as melamine coated wooden substrates, tests may be required to verify the quality of the complete board. In general, resistance to humidity and warpage cannot be guaranteed in the case of asymmetrically bonded boards.

5 BEFORE PROCESSING

5.1 Unpacking

Before opening the packaging unit, you must allow boards to acclimate to room temperature for sufficient time – at least 48 hours or longer, depending on the season.



Carefully unpack the boards.

Care must be taken whilst opening the packaging to ensure that surfaces are not damaged by sharp tools. Suitable lifting equipment must be used to separate individual boards.

Open the packaging with scissors.

Do not use a sharp blade!

1. Cut the packaging tape.
2. Cut the protective film away from sheets.
3. With 2 people, or 4 suction cups carefully lift the top board vertically, without sliding it, or carefully remove carton if individually packed.
4. Debris which can get trapped between the individual boards must be completely avoided or removed.

5.2 Checking the boards or laminates



Please check the RAUVISIO brilliant system components for the following points before further processing and thus finishing of the goods (see chapter „5.4 Documents for material warranty“):

- External damage such as cracks or marks
- Surface damage or blemishes
- Flatness (when purchasing pressed board)
- Surface tension of the laminate rear side (with purchasing single laminate)
- Colour uniformity within the production batch

The surfaces of RAUVISIO brilliant are always supplied with a protective film applied. Despite this protective film, it may be that there are occasional minor defects in the laminates on delivery. This cannot be avoided completely due to the production process and does not represent a direct cause for complaint.

Where an order utilizes multiple laminate sheets, it is recommended that laminate sheets are grouped according to manufacturing date. When processing sheets with different batch numbers, it is imperative to check the colour compatibility prior to processing.

Colour consistency should be checked in natural daylight, although bright sunlight should be avoided. In case of deviations a colorimeter should be used.



The costs incurred for checking the above mentioned points cannot be accepted by REHAU. This also applies to consequential costs incurred in the further processing of defective goods.

5.3 Conditioning



RAUVISIO brilliant and all other materials to be processed such as the substrate, adhesive, balancing foil or edgebands must be conditioned at room temperature (at least 18 °C) for a sufficient period of time (at least 48 hours).

Processing is also carried out at room temperature.

It is to be ensured, in particular in the colder months, that all boards/laminate are acclimatised. If the size of the stack prevents the laminates in the middle from acclimatising sufficiently, the acclimatisation period must be extended.

5.4 Documents for material warranty

Delivery notes and shipping labels should be retained to aid batch traceability in the event of a technical issue.

The inkjet printing on the edge of the substrate can also be used for the unique identification of a production batch. This must be given to the REHAU sales office in the event of a complaint.

6 PROCESSING RAUVISIO BRILLIANT

6.1 Proper handling of RAUVISIO boards

Placing the boards on the machine table

Cover the machine table with a clean base (chipboard, carton, etc.) or position the board upside down, protective film downwards and balancing sheet upwards.

Formatting the boards

The nesting process is recommended to cut the boards to size. When formatting with a saw, be sure to observe the instructions for placing the board on the machine table (see above). In this case, use a scorer.

Between the processing steps

After milling/sawing, all residue must be removed and all surfaces cleaned.

Stack the boards on a pallet with a clean and pliable layer of cardboard or foam between them.

Edging the boards

Anti-static agents should be used whilst edgeband is being applied. Ensure that the boards are fed into the system cleanly and safely. Any loose chipping created must be safely removed via extraction.

Drilling and milling

Extraction must be used during drilling/milling operations to ensure that the swarf is dependably removed.

Packing the boards

Stack the workpieces in layers with clean and padded carton/foam material inserted in-between on a pallet. Use a transport lock to prevent damage due to slipping or similar.

6.2 Preparing the individual laminates

6.2.1 Pre-treatment of the laminates and substrates

Manual cutting of the laminate

A blade that cuts through the protective foil and scores the acrylic surface is suitable for cutting the laminate manually. The laminate can then be broken at the cut across an edge.

Bonding of the laminate

RAUVISIO brilliant is treated with a Corona pre-treatment on the styrene copolymer underside. This pre-treatment ensures a good bond of the laminate to the adhesive. Due to a high wettability of the surface good adhesion is ensured. The wettability can be established using a test ink. The measurement for this is the surface tension, which is given in the unit [mN/m]. It has been proven that the surface tension reduces with time. It is therefore recommended that the laminate is processed within one year.

To permit secure adhesion, the surface tension must be more than 38 mN/m. In addition, at the start of each pressing operation, a test sample must be used to test the adhesive wetting of the rear side of the laminate.

After the adhesive hardens, cutting must be carried out in the substrate with laminate removal (flat fibre tears with MDF).

If the surface tension is less than 38 mN/m, the styrene copolymer rear side must be post-treated. This can be done, for example, by way of flaming, corona/plasma treatment or priming.

To avoid damage due to the lamination process, ensure a clean processing environment and sufficient cleaning of the laminates and substrate materials. Here it is important that there are no particles on the laminate and substrate after cleaning. Foreign objects of this type could leave indentations during the lamination process that are only visible once the protective film has been removed.

6.2.2 Manufacture of the pressed board

The laminate must be placed or fed in lengthwise on to the substrate. This ensures that the laminate is lying parallel to the board and is not overhanging.

6.2.3 After processing the pressed board

Before onward transport takes place, a rest period/setting time of min. 24 hours must be observed. The setting time should be agreed according to the information from the adhesive manufacturer.

For further processing, it must be checked when the subsequent fabrication steps can be carried out, depending on the adhesive system and environmental conditions. Reference can be made to the product data sheet for the adhesive.

With different colours and adhesives, there may be interactions in terms of the hardening time and adhesion. Before onward processing/shipping, ensure that there is adequate adhesion. This can be evaluated by removing the laminate from the substrate. All the fibres must be fully pulled from the substrate here.

For picking/storing individual components, it is recommended to protect the surfaces with non-woven material or similar. This will prevent marks being caused on the surface due to impurities when pressure is applied to the surfaces.

6.3 Mechanical processing of the pressed board

Sawing/milling/drilling

RAUVISIO brilliant can be processed with most approved woodworking tools. When cutting RAUVISIO brilliant, a scoring saw blade must be used.

In order to enable precise processing it must be ensured that the tools are sharp and that ideal machine settings are used. It is recommended that the optimal machine settings are determined by means of trials prior to starting production.

Cutting metal decorative designs to size

 When processing metallic decorative designs and intensive colours such as notte it is to be ensured that the installation direction of all parts is the same as the logo direction on the protective foil. If the element is installed upside down it may be the case that a different optical impression is created due to the alignment of the metal or colour particles.

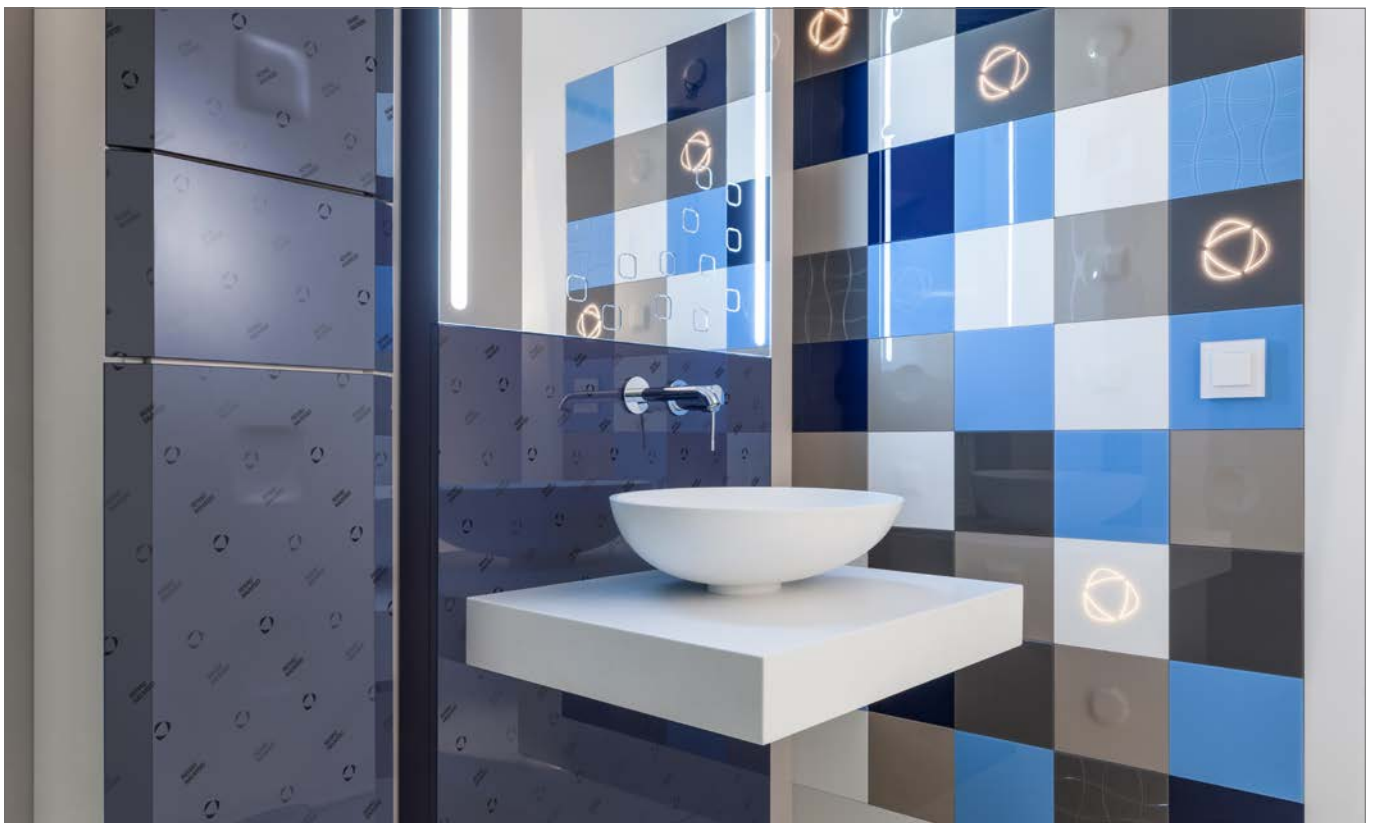

Fig. 6-1 Installation direction

6.4 Thermoforming of RAUVISIO brilliant

RAUVISIO brilliant and RAUVISIO brilliant SR matt can be thermoformed in the same way as any other thermoplastic material.



This does not apply for RAUVISIO brilliant SR high gloss as the hard coating can crack when exposed to high temperatures or during the thermoforming process.

Care must be taken to ensure that the heat input into the material is not too high – this will result in an uneven surface. If the temperature increase is too low this may cause stress cracks, or frozen-in tension that may release later on and cause cracks.

Thermoforming is therefore a very delicate area of application where the production process must be matched precisely to the laminate.

6.5 Edging

The use of a RAUKANTEX edgeband material is recommended to create a uniform appearance between the RAUVISIO brilliant surface and the narrow surface. The best visual results are achieved by using RAUKANTEX pro. No joint line is visible here thanks to the pigmented polymer functional layer in the edgeband colour. The RAUKANTEX edgeband product range can be supplied to match the surface in the materials ABS (acrylonitrile-butadiene-styrene) or PMMA (polymethylmethacrylate).

In this way, particularly with PMMA and ABS edgebands which can be polished, a finished component can be produced with an invisible joint.

Correct processing is described in the processing guidelines Technical Delivery Specifications Sales RAUKANTEX (DML00513). For more information, please contact your REHAU sales office. The resulting component quality (e.g. adhesion of the edgeband, appearance and application characteristics) depends on the machine configuration and the quality of the boards used and must be checked by the processor.

Optimum machine parameters, tool configuration and cutting speeds are to be established individually prior to production using a series of samples; the REHAU applications engineering department will be happy to support you with this.

Subsequent polishing of the radius can be carried out to achieve a seamless high gloss finish between the surface and the edgeband.



Fig. 6-2 RAUVISIO brilliant and RAUKANTEX with polished radius



REHAU offers its customers both the standard primed edgeband RAUKANTEX pure and the 100 % polymer zero joint edgeband RAUKANTEX pro (formerly RAUKANTEX laser edge).

6.6 The edged component

In addition to pure laminate and large size pressed board, REHAU gives customers the option of using the configurator to purchase customised, laser-edged components from one piece on request.



Fig. 6-3 Laser-edged component

For front applications (nominal dimension 19 mm), a successful certification was carried out in collaboration with TÜV Rheinland in accordance with AMK guidelines.

The certified component features the following quality characteristics:

- Quality
- Usability
- Regular production monitoring



The configurator for laser-edged components can be found at www.rehau.com/oberflaechenkonfigurator

7 SEALING, FINISH AND SPOT REPAIR

Finishing and sealing

After removal of the protective film the surface may be finished using the REHAU sealing kit. The sealing agent gives the surface a soft and smooth feel whilst making the surface less susceptible to mechanical loads and scratching.



With RAUVISIO brilliant SR matt, sealing should be avoided, as uneven application can result in a non-homogeneous appearance.



The application must be carried out with the sealing sponge and must leave an even film. The excess sealing agent can then be removed without any exposure time using a microfibre cloth.



It is important the laminate, sealing sponge and microfibre cloth are free from contamination prior to use as this could cause scratching of the surface.

Spot repairs, preparation of surfaces after many years of use



This does not apply for RAUVISIO brilliant SR as the hard coating does not permit grinding/polishing.

It is possible that surface marks which affect the surface may be visible after many years of use, or through improper handling. The innovative structure of RAUVISIO brilliant allows these to be removed through manual or machine grinding and polishing.

8 TECHNICAL DATA

RAUVISIO brilliant is an acrylic laminate that is made up of a co-extruded styrene copolymer and acrylic layer.

The acrylic laminate is designed for furniture/design surfaces that are used in vertical interiors. The acrylic top side is protected by a **PE foil**, which must only be removed at the installation location.

Product data	Test standard	Laminate	Pressed board with polymers Balancing sheet	Pressed board on directly coated substrate ¹⁾	Edged component
Thickness	as per technical drawing based on DIN 438-2	0.6-0.8 mm ± 0.05 mm			
Pressed board MDF substrate 12 mm	as per technical drawing based on DIN 438-2		13.5 mm ± 0.4 mm		13.5 mm ± 0.4 mm
Pressed board MDF substrate 16 mm	as per technical drawing based on DIN 438-2		17.5 mm ± 0.4 mm	16.8 mm ± 0.4 mm	17.5 mm ± 0.4 mm
Pressed board MDF substrate 18 mm	as per technical drawing based on DIN 438-2		19.5 mm ± 0.4 mm		19.5 mm ± 0.4 mm
Pressed board MDF substrate 28 mm	as per technical drawing based on DIN 438-2		29.5 mm ± 0.4 mm		29.5 mm ± 0.4 mm
Width	as per technical drawing based on DIN 438-2	1300 mm ± 2.0 mm	1300 mm ± 2.0 mm	1220 mm ± 2.0 mm	Dimension ± 0.5 mm
Length	as per technical drawing based on DIN 438-2	2800 mm ± 5.0 mm	2800 mm ± 5.0 mm	2440 mm ± 5.0 mm	Dimension ± 0.5 mm
Angle deviation	as per technical drawing based on DIN 438-2	90° ± 0.3°	90° ± 0.3°	90° ± 0.3°	max. 0.5 mm / 1000 mm
Edge defects	as per technical drawing based on DIN 438-2	15 mm	15 mm	15 mm	

1) no guarantee for component tests in accordance with AMK

Visual properties	Test standard	Requirements	Test result
Surface gloss level	AMK-MB-009, 09/2010	Measurement with 60° measurement geometry	≥ 85 GLE high gloss < 6 GLE matt
Colour	AMK-MB-009, 09/2010	no significant changes to the master sample; uniform covering properties	Fulfilled
Surface	AMK-MB-009, 09/2010 following EN ISO 7823-2*	uniform surface, surface defects must not affect the overall appearance from a distance of 0.7 m. A totally flawless surface is not feasible due to production tolerances. Some minor surface irregularities are possible.	Fulfilled

Lightfastness	based on DIN EN ISO 4892-2, process B Duration of the test: to DIN EN ISO 105 B01-B06 Assessment of the sample: to DIN EN ISO 105 A02	Assessment according to the blue scale Assessment according to the grey scale	Level 7 ≥ level 4
---------------	---	--	----------------------

* This standard refers exclusively to the extrusion process step; downstream process steps are not taken into account.

Material properties	Test standard	Requirement
Density (acrylic laminate)	DIN EN ISO 1183-1 (05.04)	1.06 g/cm ³
Fire behaviour	DIN 4102/1	B 2
Material purity/sand content	Residue on ignition according to test specification	≤ 1 %

Surface properties	Test standard	Requirements	Test result		
Surface tension adhesive side	Testing using test ink	≥ 44 mN/m on delivery	≥ 38 mN/m during gluing		
Chemical resistance *	DIN 68861 / T1	1A/1B	see "Substances" table page 21		
Behaviour in dry heat	DIN 68861/T7	Stress group min. 7 D	No change at 70 °C		
Behaviour in moist heat	DIN 68861/T8	Stress group min. 8 B	No change at 70 °C		
Behaviour in water vapour	DIN 438-2	Level 5			
Scratch-resistance			RAUVISIO brilliant	RAUVISIO brilliant SR gloss	RAUVISIO brilliant SR matt
	DIN 68861/T4		Class 4D	Class 4D	Class 4B
Micro-scratch resistance	DIN CEN TS 16611 process A		Class 4	Change in gloss level 5% (measurement with 60° measurement geometry)	Change in gloss level 18% (measurement with 60° measurement geometry)
	DIN CEN TS 16611 process B		Class 2	Class 5	Class 5

* The testing of chemical resistance according to DIN 68861-1 includes the substances given in the table on page 19; other substances have not been tested specifically and are to be tested by the customer separately.

Component tests on the edged component

The scope of supply from REHAU includes the RAUVISIO brilliant with and without edging. The details below refer to the finished, edged component with RAUKANTEX pro. Please note that REHAU only accepts warranty liability for its scope of supply as per the REHAU specification, not for the finished, edged component. The results of the component tests on the finished, edged component are dependent on the machine and process parameters to be set by the customer for processing RAUVISIO brilliant, using the suitable edgeband as well as full compliance with the REHAU processing instructions in accordance with this Technical Information. With regard to setting the machine and process parameters, the REHAU technical applications department will provide the appropriate support. Please note that our advice relating to technical applications is correct to the best of our knowledge, but we cannot accept any liability for this free service, which is provided without obligation.

Component tests	Test standard	Test result
Temperature resistance	Assessment to AMK-MB-001 (05/03)	passed
Infiltration of water vapour	Assessment to AMK-MB-005 (07/2007), Module 1	passed
Humid climate resistance	Assessment to AMK-MB-005 (07/2007), Module 2	passed
Alternating climate resistance	Assessment to AMK-MB-005 (07/2007), Module 3	passed
Long-term heat storage 4 weeks 50 °C	Assessment after 24h acclimatisation	passed

Technical data RAUVISIO brilliant BALANCING SHEET

The balancing sheet matched in colour to RAUVISIO brilliant consists of coextruded polymer that has a fine embossing. The balancing sheet is designed for the reverse of furniture/design surfaces that are used in vertical interiors.

Product data	Test standard	Dimensions
Thickness	as per technical drawing based on DIN 438-2	0.6–0.7 mm ± 0.05 mm
Width	as per technical drawing based on DIN 438-2	1300 mm ± 2.0 mm
Length	as per technical drawing based on DIN 438-2	2800 mm ± 5.0 mm
Angle deviation	as per technical drawing based on DIN 438-2	90° ± 0.3°

Visual properties	Test standard	Requirements	Test result
Colour			no significant change to the master sample; even covering Properties
Surface	AMK-MB-009, 09/2010	uniform surface, surface defects must not have a distracting effect from a distance of 0.7 m. A totally flawless surface is not feasible due to production tolerances. Some minor surface irregularities are possible.	Fulfilled

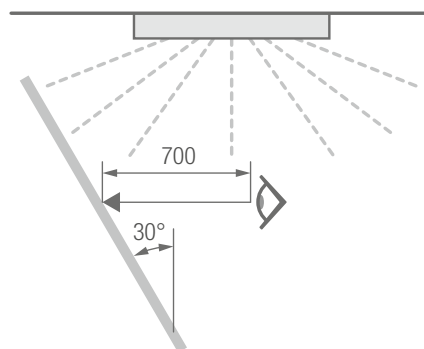

Material properties	Test standard	Requirement
Fire behaviour	DIN 4102/1	B 2
Material purity/sand content	Residue on ignition according to test specification	≤ 1 %

Surface finish	Test standard	Requirements	Test result
Surface tension adhesive side	Testing using test ink	≥ 44 mN/m on delivery	≥ 38 mN/m during gluing
Behaviour in dry heat	DIN 68861/T7	Stress group min. 7 D	No change at 70 °C
Behaviour in moist heat	DIN 68861/T8	Stress group min. 8 B	No change at 70 °C
Behaviour in water vapour	DIN 438-2	Level 5	
Scratch-resistance	DIN 68861/T4	Class 4B	

9 INSTALLATION GUIDELINES

1. The raw laminate and fabricated elements should only be transported on the original packaging unit.
2. Always unload packaging units sideways and from the middle.
3. The raw laminate and fabricated elements should always be stored on the original pallet or with 4-timber storage.
4. The raw laminate and fabricated elements must not be stored outside or in damp rooms.
5. Raw laminates and fabricated elements should always be stored appropriately at the installation location and not exposed to strong UV light sources.
6. Acclimatise fabricated elements prior to installation for at least 24 hours at room temperature (min. 18°C). At delivery temperatures below 0 °C, acclimatise the elements for at least 48 hours on all sides.
7. No objects are to be rested on raw boards and fabricated elements as these could cause damage.
8. RAUVISIO brilliant is suitable for vertical applications indoors. Enquire and check with the manufacturer about special application cases if necessary.
9. All materials and components must be checked for damage or defects prior to processing / assembly.
10. Temporary storage must take place prior to installation exclusively in the original packaging in frost-free and closed rooms.
11. Load-bearing substructures, which are firmly connected to each other, are to be aligned so that they are flat and vertical.
12. To avoid stress cracks no bending should occur during processing and assembly.
13. Do not bring unprotected corner connections of wooden substrates into contact with moisture prior to assembly.
14. In the case of wooden substrates all cut edges and raw board edges must be sealed so that they are watertight.
15. All drilled holes in the wooden substrates must be sealed during assembly so that they are watertight.
16. Tools must not be used on the surface.
17. No strong solvents, special cleaners (e.g. drain cleaners, industrial cleaners, lubricants or abrasive cleaning cloths) or strong chemical substances must be used on the surface.
18. Heavy dirt can cause scratches during cleaning, therefore always clean dirty areas carefully with a microfibre cloth.
19. Do not stand on unassembled or assembled RAUVISIO brilliant elements.
20. Assembly for indoor vertical applications only.



National standards, specifications, legislation, operating instructions (e.g. electronic devices) or similar must be observed.

10 CARE AND USAGE INSTRUCTIONS FOR THE END USER



The non-porous, homogeneous acrylic surface material is easy to clean and suitable for contact with foodstuffs and is resistant to fungal and bacterial growth.



RAUVISIO brilliant is pleasant to the touch, warm and has an excellent visual depth effect.



RAUVISIO brilliant is resistant to most substances found in the household. Prolonged exposure to aggressive substances can leave behind marks or damage the material.

Assessment as per DIN EN 12720 (07/2009)

Chemical durability	Result
5	No visible change
4	Just noticeable change in gloss or colour
3	Slight change in gloss or colour; the structure of the test surface is not changed
2	Heavy marks visible; the structure of the test surface is however largely undamaged
1	Heavy marks visible; the structure of the test surface is changed
0	Test surface severely changed or destroyed

The table shows the media tested and the exposure time:

Substances	Stress group 1A/1B					
	RAUVISIO brilliant		RAUVISIO brilliant SR gloss		RAUVISIO brilliant SR matt	
	T	Result	T	Result	T	Result
Acetic acid	16 h	5	16 h	5	16 h	5
Citric acid	16 h	5	16 h	5	16 h	5
Ammonia water	16 h	5	16 h	5	16 h	5
Ethyl alcohol	16 h	5	16 h	5	16 h	5
Red wine	16 h	5	16 h	5	16 h	5
Beer	16 h	5	16 h	5	16 h	5
Cola	16 h	5	16 h	5	16 h	5
Coffee	16 h	5	16 h	5	16 h	5
Black tea	16 h	5	16 h	5	16 h	5
Blackcurrant juice	16 h	5	16 h	5	16 h	5
Evaporated milk	16 h	5	16 h	5	16 h	5
Water	16 h	5	16 h	5	16 h	5
Petrol	16 h	5	16 h	5	16 h	5
Acetone	16 h	1	10 s	5	10 s	5
Ethyl-butylacetate	16 h	1	10 s	5	10 s	5
Butter	16 h	5	16 h	5	16 h	5
Olive oil	16 h	5	16 h	5	16 h	5
Mustard	16 h	5	16 h	5	16 h	5
Onion	16 h	5	16 h	5	16 h	5
Disinfectants	16 h	3–4	16 h	5	16 h	5
Cleaning agent	16 h	5	16 h	5	16 h	5
Cleaning solution	16 h	5	16 h	5	16 h	5

T Exposure time

A Requirement as classification code to DIN EN 12720:2009-07



No scouring or alcoholic cleaning agents must be used for cleaning, there is a risk that these will attack and damage the surface.

Heavy dirt must be removed with a soft cloth (microfibre cloth) and soapy water; you will then be able to restore the high quality appearance using the REHAU sealing agent. This specially matched sealing agent improves the feel and protects the surface during day-to-day use, so you are certain to get long-term enjoyment from your exclusive acrylic surface.



With RAUVISIO brilliant SR matt, sealing should be avoided, as uneven application can result in a non-homogeneous appearance.

NOTES

This document is protected by copyright. All rights based on this are reserved. No part of this publication may be translated, reproduced or transmitted in any form or by any similar means, electronic or mechanical, photocopying, recording or otherwise, or stored in a data retrieval system.

Our verbal and written advice with regard to usage is based on years of experience and standardised assumptions and is provided to the best of our knowledge. The intended use of REHAU products is described comprehensively in the technical product information. The latest version can be viewed at www.rehau.com/IT. We have no control over the application, use or processing of the products. Responsibility for these activities therefore remains entirely with the respective user/processor. Where claims for liability nonetheless arise, they shall be governed exclusively according to our terms and conditions, available at www.rehau.com/conditions, insofar as nothing else has been agreed upon with REHAU in writing. This shall also apply for all warranty claims, with the warranty applying to the consistent quality of our products in accordance with our specifications. Subject to technical changes.

We're never far away.
Exactly where is shown at
www.rehau.de/standorte

© REHAU AG + Co
Rheniumhaus
95111 Rehau

Subject to technical changes
002600 EN 11.2018