



**Engineering progress  
Enhancing lives**

## **RAUPIANO PLUS plumbing system**

The versatile acoustic drainage and  
trade waste system

**PRODUCT BOOK AND  
INSTALLER GUIDE - Australia**



# Contents

Information and safety recommendations	3
System Information	4
Transportation, storage and handling	6
Product list	7
Trade waste	17
Acoustic performance	18
Assembly procedure	19
Joining process	20
Cutting pipes	20
Deburring and chamfering	21
Push-fit joint	22
Withdraw 10mm	23
<b>Pipe support</b>	<b>24</b>
Brackets	25
Sound dampening bracket	26
Vertical stack	27
Horizontal line	28
Anchor points	30
<b>Inspection opening access</b>	
pipe and pipe cap	31
Push-fit lock	32
<b>P trap siphon/110mm disconnecter gully</b>	<b>34</b>
Floor waste gully - installation	35
Installation advices	37
Connection to PVC pipe	38
Connexion to other metal or plastic pipe	39
Connection to cast iron	41
Leak test	42
Fire protection solutions	43
Overview	44



# RAUPIANO PLUS

## Information and safety recommendations

### Notes on this Installation Guide

#### Applicability

This Installation guide is applicable for Australia.

This Installation guide is subject to technical modification and meant to be used in conjunction with the latest version of REHAU's Installation and Technical Manual "RAUPIANO PLUS". For current information, please contact your REHAU Sales Office.

The current technical information is available from your REHAU sales office, or as download on the internet at **[www.reece.com.au](http://www.reece.com.au)**, **[www.rehau.com.au/raupiano](http://www.rehau.com.au/raupiano)** or **[www.myrehau.com/downloads](http://www.myrehau.com/downloads)**

All schematics show general examples only and are not intended to satisfy the installation requirements for any particular project. Specific measures for fire protection, acoustics, structural integrity etc. may or may not be required depending on building class and design. Check with responsible experts and refer to the National Construction Code for detailed information.

### Pictograms and logos



Legal information



Important information



Information on the Internet



Advantage

# RAUPIANO PLUS

## System information

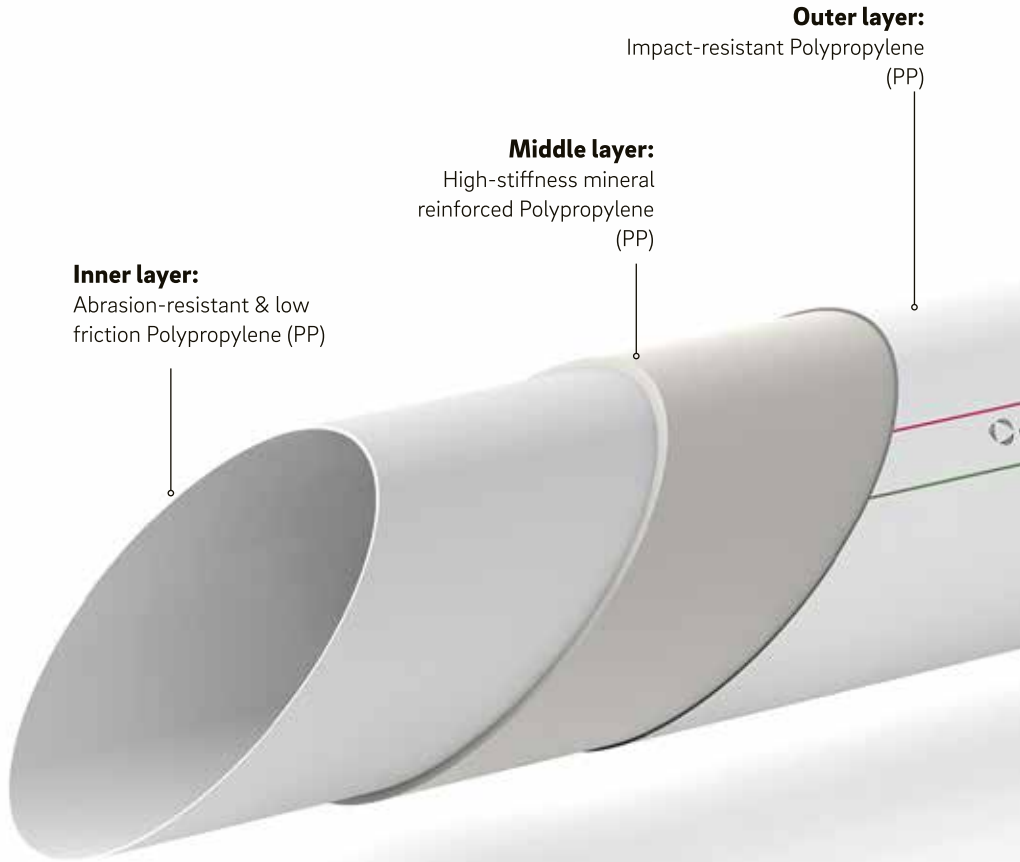

**Sound absorbing bends**

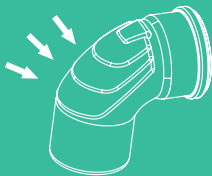

**Rubber-lined brackets**

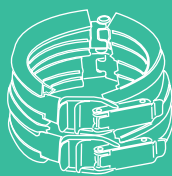

**Lubricant**

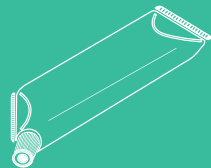

REHAU RAUPIANO PLUS



### **System Advantages**

- Excellent sound-insulation properties
- Eliminates acoustic-lagging
- Fast and easy installation
- The joint is designed to absorb thermal expansion
- High quality product made from 'Green', non-toxic, recyclable material without halogen

# RAUPIANO PLUS

## Transportation, storage and handling

### Transportation

RAUPIANO PLUS is a generally robust product owing to its three-layer structure and impact-resistant outer layer. Ensure that pipes make firm contact over their entire length.

### Storage

- Protect boxes from moisture during transport and storage.
- RAUPIANO PLUS and its seals can be stored outdoors for up to 1 year

#### Correct transportation procedure

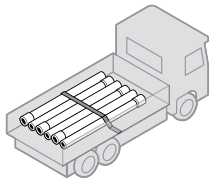

Where possible use a truck for deliveries.  
Lay pipe flat on the tray

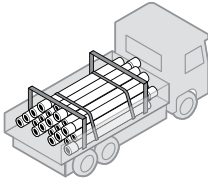

Keep pipes strapped down so they don't roll around and remain supported

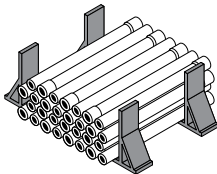

Alternate socket and pipe ends when loading

#### What not to do

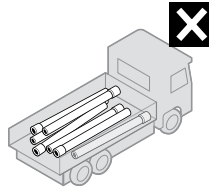

Do not throw pipes into the tray

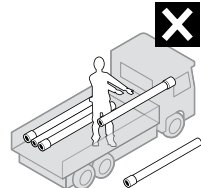

Do not throw pipes off the ute

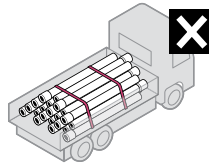

Do not over tighten with ratchet

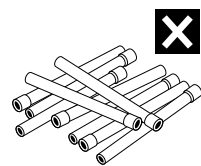

Take care with O-rings and ensure they are in good condition

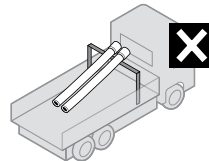

Do not transport pipes unsupported as they may bend.

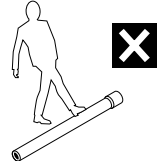

Keep pipes clear of building debris whilst on site

# RAUPIANO PLUS

## Product list

### Pipe Sizing Chart

PVC		RAUPIANO PLUS	
DN	OD (mm)	DN	OD (mm)
40	43	40	40
50	56	50	50
65	69	75	75
100	110	110	110
150	160	160	160

### Pipes

With push-fit socket and rubber sealing ring

**Material:** RAU-PP (mineral reinforced)

**Colour:** white

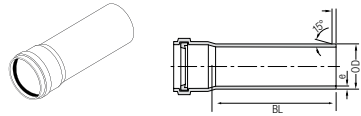

REHAU Article	REECE Code	DN/OD in mm	e in mm	Length (mm) BL
123014	1450819	40	1.8	250
123024	1450820	40	1.8	500
109483	726015	40	1.8	1000
109492	726016	40	1.8	3000
120104	1450825	50	1.8	250
120114	1450826	50	1.8	500
109493	726017	50	1.8	1000
109494	726018	50	1.8	3000
120184	1450833	75	1.9	250
120194	1450834	75	1.9	500
109495	726019	75	1.9	1000
109496	726020	75	1.9	3000
120264	1450848	110	2.7	250
120274	1450849	110	2.7	500
109497	726021	110	2.7	1000
109498	726022	110	2.7	3000
122954	1450863	160	3.9	500
121664	1450864	160	3.9	1000
121684	1450866	160	3.9	3000

# RAUPIANO PLUS

## Product list

### Bend

With rubber sealing ring

**Material:** RAU-PP (mineral reinforced)

**Colour:** white

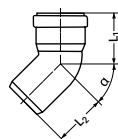

REHAU Article	REECE Code	DN/OD in mm	Angle	L <sub>1</sub> (mm)	L <sub>2</sub> (mm)
123064	1450724	40	15°	47	50
121094	1450728	50	15°	50	54
121144	1450733	75	15°	56	60
123132	1450710	110	15°	66	71
123092	1450969	160	15°	80	87
123074	1450725	40	30°	49	53
121104	1450729	50	30°	54	57
121154	1450734	75	30°	61	64
123135	1450711	110	30°	74	78
123096	1450970	160	30°	92	99
123084	1450726	40	45°	52	56
121114	1450730	50	45°	57	61
121164	1450735	75	45°	67	70
123136	1450712	110	45°	82	86
124028	1450720	160	45°	106	110

### Swept Bend

With rubber sealing ring

**Material:** RAU-PP (mineral reinforced)

**Colour:** white

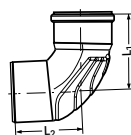
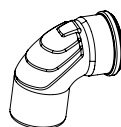

REHAU Article	REECE Code	DN/OD in mm	Angle	L <sub>1</sub> (mm)	L <sub>2</sub> (mm)
100255	1450972	40	87°	78	72
100276	1450973	50	87°	87	85
100278	1450974	75	87°	110	108
100259	1450971	110	87°	141	133
124029	1450721	160	87°	160	142
100564	1451094	160	87°	219	216

Note: <sup>(1)</sup> Swept angle



## Single Branch junction

With rubber sealing ring

**Material:** RAU-PP (mineral reinforced)

**Colour:** white

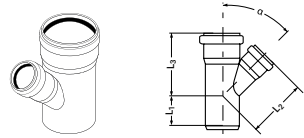

REHAU Article	REECE Code	DN/OD in mm	Angle	L <sub>1</sub> (mm)	L <sub>2</sub> (mm)	L <sub>3</sub> (mm)
123104	1450902	40/40	45°	91	91	134
121234	1450904	50/50	45°	106	106	151
121264	1450906	75/50	45°	128	119	178
121294	1450908	75/75	45°	140	140	190
121304	1450916	110/50	45°	161	136	218
121334	1450918	110/75	45°	173	158	230
122984	1450920	110/110	45°	191	191	248
124037	1450926	160/110	45°	237	254	304
124038	1450930	160/160	45°	265	265	332
123114	1450903	40/40	87°	67	67	110
121254	1450905	50/50	87°	75	75	120
121284	1450907	75/50	87°	92	76	142
121544	1450909	75/75	87°	92	92	142
121324	1450917	110/50	87°	117	77	174
121344	1450919	110/75	87°	117	94	174
123005 <sup>(1)</sup>	1450921	110/110	87°	130	78	58
124069	1450927	160/110	87°	154	146	221
124077	1450931	160/160	87°	157	157	224

Note: <sup>(1)</sup> Swept angle

## Double Branch junction

With rubber sealing rings

**Material:** RAU-PP (mineral reinforced)

**Colour:** white



REHAU Article	REECE Code	DN/OD in mm	Angle
122964	1450756	110/110/110	45°
123076	1450759	160/110/110	45°
121554*	1450757	110/110/110	87°

\* Stormwater applications only

# RAUPIANO PLUS

## Product list

### Reducer with rubber sealing ring

Material: RAU-PP (mineral reinforced)

Colour: white

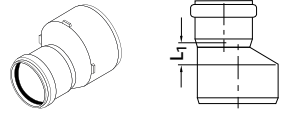

REHAU Article	REECE Code	DN/OD in mm	L <sub>1</sub> (mm)
123124	1450871	50/40	12
121384	1450872	75/50	20
121394	1450875	110/50	40
121404	1450876	110/75	26
124039	1450879	160/110	33

### PVC Adaptor

Material: PVC

Colour: white

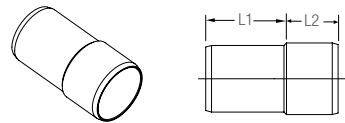

REHAU Article	REECE Code	RAUPIANO DN/ OD in mm	PVC DN	L <sub>1</sub> (mm)	L <sub>2</sub> (mm)
123009	1450706	40	40	47	31
123012	1450707	50	50	48	34
123016	1450708	75	65	43	51

### PVC Adaptor Bush

Material: PVC

Colour: white

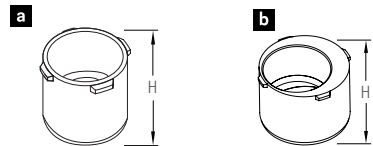

REHAU Article	REECE Code	RAUPIANO DN/OD in mm	PVC DN	H (mm)
103525 (a)	1451089	50	40	48.5
103526 (b)	1451090	75	50	54.9

## Double Socket

With rubber sealing rings

**Material:** RAU-PP (mineral reinforced)

**Colour:** white

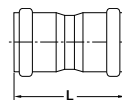

REHAU Article	REECE Code	DN/OD in mm	L (mm)
123144	1450768	40	89
132624	1450769	50	93
121584	1450770	75	111
121494	1450772	110	128
124047	1450774	160	148

## Slip-on Socket

With rubber sealing rings

**Material:** RAU-PP (mineral reinforced)

**Colour:** white

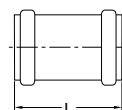

REHAU Article	REECE Code	DN/OD in mm	L (mm)
123154	1450935	40	89
132625	1450936	50	93
121574	1450937	75	111
121514	1450939	110	128
124048	1450941	160	148

## I.O. Access Pipe

With surface-flushing insert and screwed cap and rubber sealing ring

**Material:** RAU-PP (mineral reinforced)

**Colour:** white

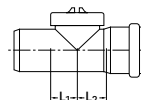

REHAU Article	REECE Code	DN/OD in mm	L <sub>1</sub> (mm)	L <sub>2</sub> (mm)
121039	1450805	50	28	30
123079	1450806	75	40	43
121534	1450808	110	57	62
124079	1450810	160	83	89

# RAUPIANO PLUS

## Product list

### Socket Plug

**Material:** RAU-PP (mineral reinforced)

**Colour:** white



REHAU Article	REECE Code	DN/OD in mm	L (mm)
121454	1450944	50	34
121464	1450945	75	35
121474	1450947	110	37
123134	1450943	40	33
123106	1450949	160	49

### Securing Clip

For securing the socket plug and should be ordered in conjunction with either socket plug 121474 or 123774

**Material:** Galvanized steel

**Colour:** Silver

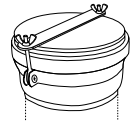

REHAU Article	REECE Code	DN in mm
123000	1450951	110
123002	1450952	160

### Push-fit lock

To prevent the push-fit joint from sliding apart at higher pressure and improve pressure resistance up to 2 bars.

Supplied together with the necessary bolts and nuts

**Material:** Polyamide

**Color:** Black



REHAU Article	REECE Code	ID in mm
100659	1450982	40
100661	1450983	50
100662	1450984	75
100664	1450985	110
102946	1450986	160

## Long Socket

With rubber sealing ring

**Material:** RAU-PP (mineral reinforced)

**Colour:** white

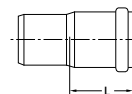

REHAU Article	REECE Code	DN/OD in mm	L (mm)
121594	1450812	110	130

## P-trap

To be used in conjunction with either DN 50 or DN 110 45 degree bend. With rubber sealing ring and fixing eyelet.

**Material:** RAU-PP (mineral reinforced)

**Colour:** white

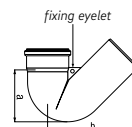

REHAU Article	REECE Code	DN/OD in mm	a (mm)	b (mm)
123115	1448659	50	93	164
123039	1450870	110	142	251

\*Commonly used bracket with fixing eyelet

## Floor Waste Gully

With 3x DN 50 inlets + 1 x DN75 outlet.

Includes bracket.

DN50 inlets require DN50 double socket

**Material:** RAU-PP (mineral reinforced)

**Colour:** white

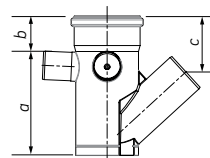
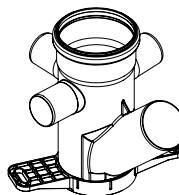

REHAU Article	REECE Code	DN/OD in mm	a (mm)	b (mm)	c (mm)
108971	1451209	50/50/50/75	254	87	98
108843*	1451208				

\*Bracket only

## Floor Waste Gully with trap

With 3x DN 50 inlets + 1 x DN75 outlet.

Includes removable baffle.

DN50 inlets require DN50 double socket

**Material:** RAU-PP (mineral reinforced)

**Colour:** white

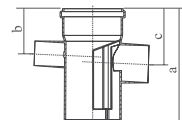

REHAU Article	REECE Code	DN/OD in mm	a (mm)	b (mm)	c (mm)
108489	1450960	50/50/50/75	222	87	105

# RAUPIANO PLUS

## Product list

### Shower Gully

With 1 x DN 50 inlet + 1 x DN50 outlet.  
Includes removable baffle.  
DN 50 inlet requires DN 50 double socket

**Material:** RAU-PP (mineral reinforced)

**Colour:** white

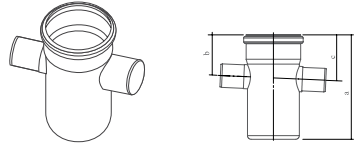

REHAU Article	REECE Code	DN/OD in mm	a (mm)	b (mm)	c (mm)
108490	1448660	50/50	222	87	96

### 4-Way Riser

With 2 x DN 50 inlets + 2 x DN 40 inlets.  
DN 50 inlet requires DN 50 double socket,  
DN 40 inlet requires DN 40 double socket

**Material:** RAU-PP (mineral reinforced)

**Colour:** white

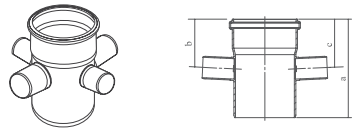

REHAU Article	REECE Code	DN/OD in mm	a (mm)	b (mm)	c (mm)
104978	1448657	50/50/40/40	175	91	91

### Connection Pipe

For connection to other pipe materials. To be  
used together with rubber nipple

**Material:** RAU-PP (mineral reinforced)

**Colour:** white

**Application:** refer to page 38

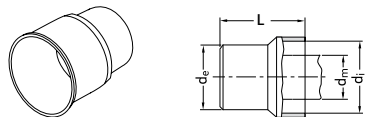

REHAU Article	REECE Code	DN/OD in mm	Metal pipe outer $d_m$	$d_e$ (mm)	$d_i$ (mm)	L (mm)
121414	1450753	50/40-30	32 - 40	50	53.7	61
121424	1450754	50/50	47 - 50	50	67.2	50

## Rubber Sealing Ring

For pipe and fitting sockets

**Material:** rubber

**Colour:** black



REHAU Article	REECE Code	OD in mm
120089	1451309	40
120095	1451310	50
120096	1451311	75
120099	1451312	110
120106	1451313	160

## Rubber Nipple

For connection to other pipe materials. To be used together with connection pipe

**Material:** rubber

**Colour:** black

**Application:** refer to page 38

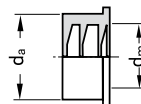

REHAU Article	REECE Code	DN in mm	Metal pipe outer $d_m$	$d_a$ (mm)
126253	1450882	50/40	32 - 40	55
121913	1450883	50/50	47 - 50	68

## Rubber Nipple with Bead

For connection to other pipe materials. Replaces the pre-assembled rubber sealing ring in RAUPIANO PLUS pipes or fittings.

**Material:** rubber

**Colour:** black

**Application:** refer to page 39

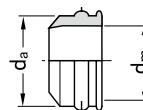

REHAU Article	REECE Code	DN in mm	$d_a$ (mm)	Metal pipe outer $d_m$
122923	1450884	40/30	40.5	32 - 40
122933	1450885	50/30	50.5	32 - 40
122943	1450886	50/40	50.5	47 - 50

## Lubricant

For push-fit connections



REHAU Article	REECE Code	Size
176520	1450814	250 g
172960	1450815	500 g

# RAUPIANO PLUS

## Product list

### Sound-dampening Support Bracket

**Material:** galvanised strip steel

**Colour:** Black

**Includes:** Supporting and fastening clamps and headless screw

**Application:** 1 per stack per floor. Refer to Page 26



REHAU Article	REECE Code	DN in mm
122004	1450954	75
122014	1450956	110
122034	1450958	160

### Fixed/Guiding Bracket

With rubber lining and distance piece

**Material:** galvanised strip steel

**Colour:** Green with yellow adjustment spacers.

Some spacers to be removed for fixing/security bracket application.

**Application:** Used as a fixing/security or guiding bracket. refer to Pages 24-25 for further details.



Some spacers removed for fixed bracket

With spacers for guiding bracket

REHAU Article	REECE Code	DN in mm
	510765	40
	510766	50
	510769	75
	510771	110
	510772	160

Refer to Pages 24-25 for details of each size

### RAUVENT

**Material:** RAU-PP (mineral reinforced)

**Colour:** white

REHAU Article	REECE Code	DN in mm	Configuration
186484	1451125	110/110	L inlet
186485	1451126	110/110	R inlet
186482	1451129	110/110	L+R inlet
186483	1451130	110/110	C+L+R inlet
106483	1451100	110/110	C inlet
106484	1451101	110/110	C+L inlet
106482	1451102	110/110	C+R inlet

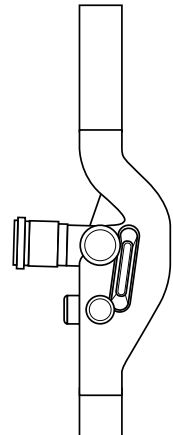

Please check the store for lead times.





## RAUPIANO PLUS

### Greasy trade waste

With its outstanding system properties, RAUPIANO PLUS can be used in more challenging environments. It is resistant to various types of chemicals ranging from pH 2 to pH 12. RAUPIANO PLUS can also withstand extreme temperatures. It can handle hot water up to 98°C for brief periods making it an excellent system for greasy trade waste applications.\* It can also be installed under extremely cold conditions of -10°C.

For industrial applications consult your local REHAU office.

\* Refer to RAUPIANO Technical Information for further details on discharge temperatures and rates.

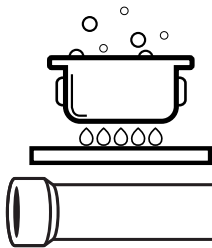

commercial kitchens

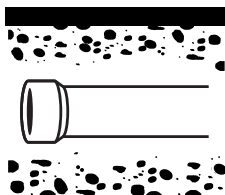

in-concrete

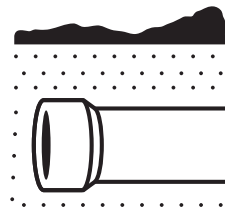

in-ground

# RAUPIANO PLUS

## Acoustic performance

RAUPIANO PLUS pipe system exceeds the  $R_w + C_{tr}$  40 requirements of the National Construction Code Vol. 1 / Building Code of Australia. A stand alone RAUPIANO PLUS system is comparable, in terms of sound insulation, to a fully lagged PVC system behind a specified ceiling separation. Refer to RAUPIANO PLUS Installation and Technical Manual, Chapter 4 - Sound insulation.

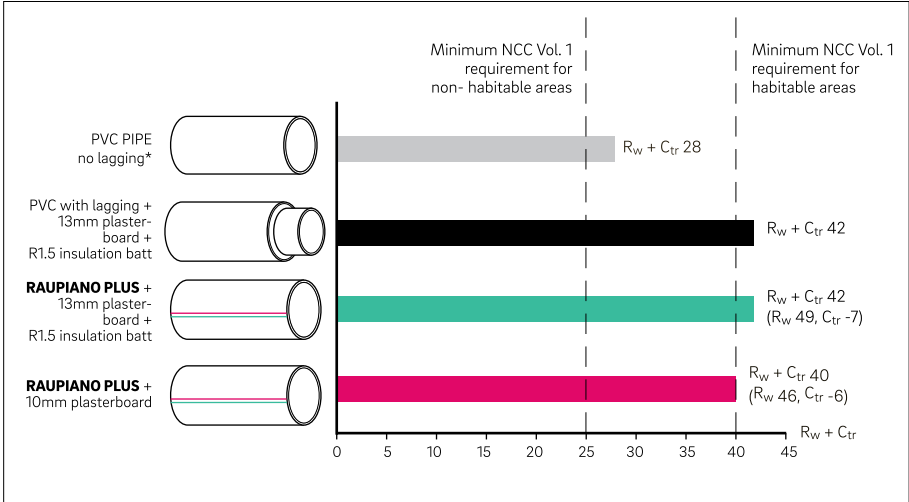

### Acoustic testing

\* Boral Selector + Feb 2009 - System WP13, 13mm std core plasterboard with insulation (Graeme E Harding & Associates)

### Buildings not regulated by NCC/BCA

The acoustic requirements of buildings outside of NCC/BCA's scope tend to be different. The rooms are normally classified differently, and therefore have different noise level requirements.

RAUPIANO PLUS has gone through extensive acoustic testing with different ceilings, ranging from flush plasterboard to Rondo ceiling grid system with lay in tiles, and with different plasterboard thicknesses.

✓ From very extensive raw data collected through real-life acoustic tests, AECOM assessed the acoustic performance of RAUPIANO PLUS and it was positively concluded that RAUPIANO PLUS achieves  $R_w + C_{tr}$  40 ( $R_w$  46) with a 10mm plasterboard ceiling. That means RAUPIANO PLUS satisfies NCC's acoustic requirements for habitable and non-habitable areas with just 10 mm plasterboard, without lagging and without insulation batt.



Acoustic assessment letters from Acoustic Consultants (Renzo Tonin & Associates, ASK Consulting Engineers and Aecom) can be found in the RAUPIANO Technical Information (available to download at <https://www.rehau.com/au-en/plumbing-and-drainage> and [www.myrehau.com](http://www.myrehau.com)). For further information and complete reports, please contact REHAU.

# RAUPIANO PLUS

## Assembly procedure



Visit [www.myrehau.com/training](http://www.myrehau.com/training) for quick, instructional videos and planning tips.

### 3 Steps Installation

#### Step 1

Cut, chamfer and deburr

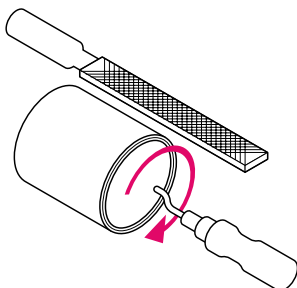

#### Step 2

Lubricate

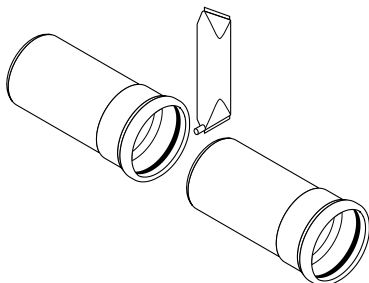

#### Step 3

Push it in

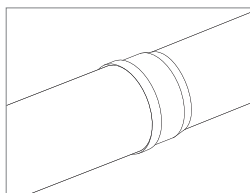
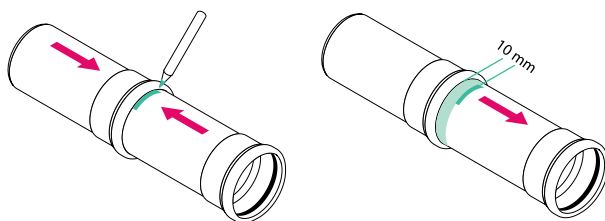

**10mm withdrawal is not required for:**

- In ground installation
- Pipe length <500mm
- Fitting-to-fitting connection

# RAUPIANO PLUS

## Jointing process - cutting pipes

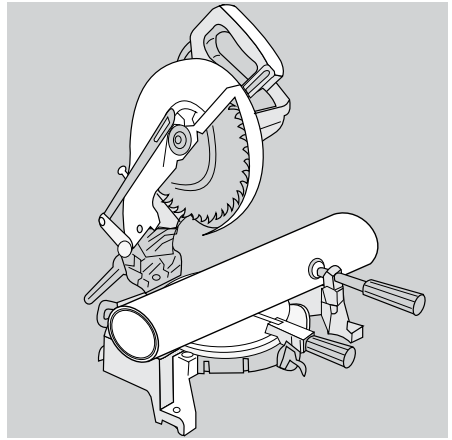
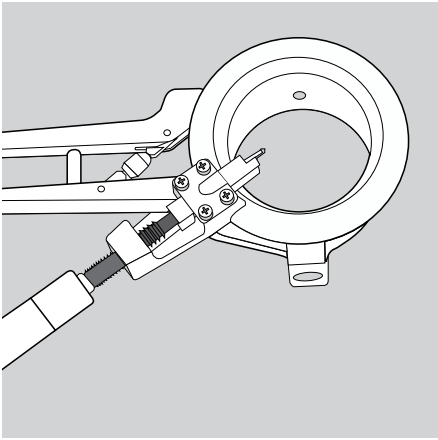
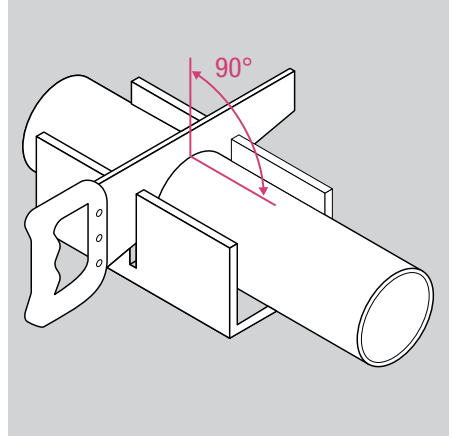
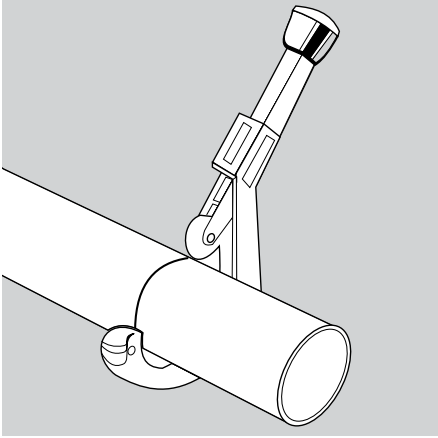

- 1 Ensure that the pipe is secured properly prior to cutting
- 2 Cut the pipes with common pipe cutters or a fine-toothed saw.  
Cut pipe at a 90° angle from the pipe axis.

# RAUPIANO PLUS

## Jointing process - deburring and chamfering

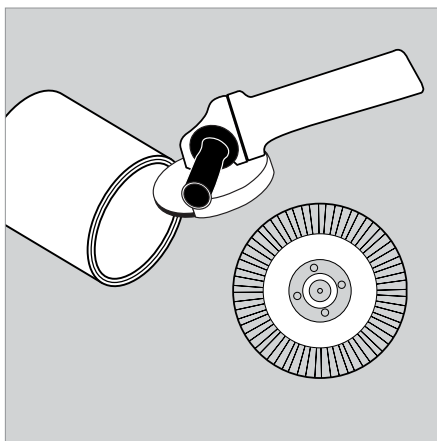
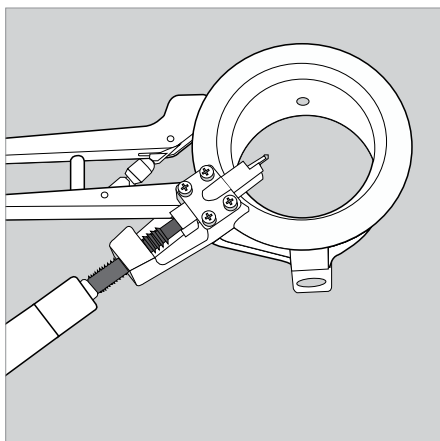
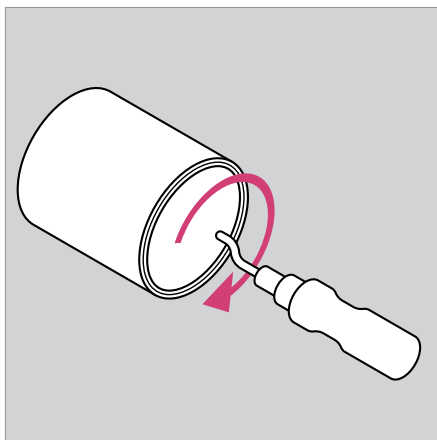
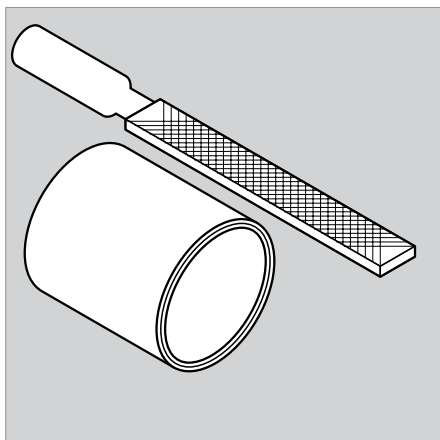

- 1 De-burr the inner diameter of the pipe.
- 2 For connections to push-fit socket pipe systems, taper the pipe ends with a tapering tool (i.e. Rothenberger Rocut cutter and chamferring tool 55020 DN 110 (Reece code: 7705255) or a coarse file at an angle of approximately 15°.

# RAUPIANO PLUS

## Push-fit joint

### Pipe Assembly

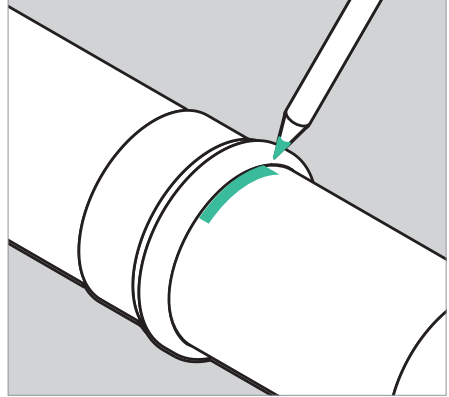
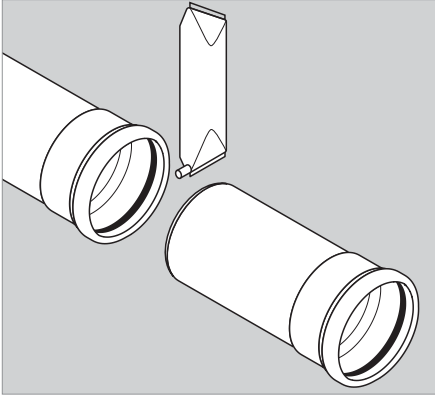

- 1 Clean dirt from sealing ring, socket interior and pipe end.
- 2 Use small amount of RAUPIANO lubricant (eg. a 10mm drop) to moisten chamfered pipe and O-ring then slide into the socket until it stops.
- 3 Once fully inserted, leave a witness mark with pencil or permanent marker.

**Note:** Please ensure seals are clean and free from dirt, dust or grime. If required, remove seal and wash in water to remove debris. Ensure to replace seal in direction of flow.



Please ensure the use of REHAU lubricant! (No other lubricant is to be used unless otherwise approved by REHAU)

# RAUPIANO PLUS

## Jointing process - withdraw 10mm

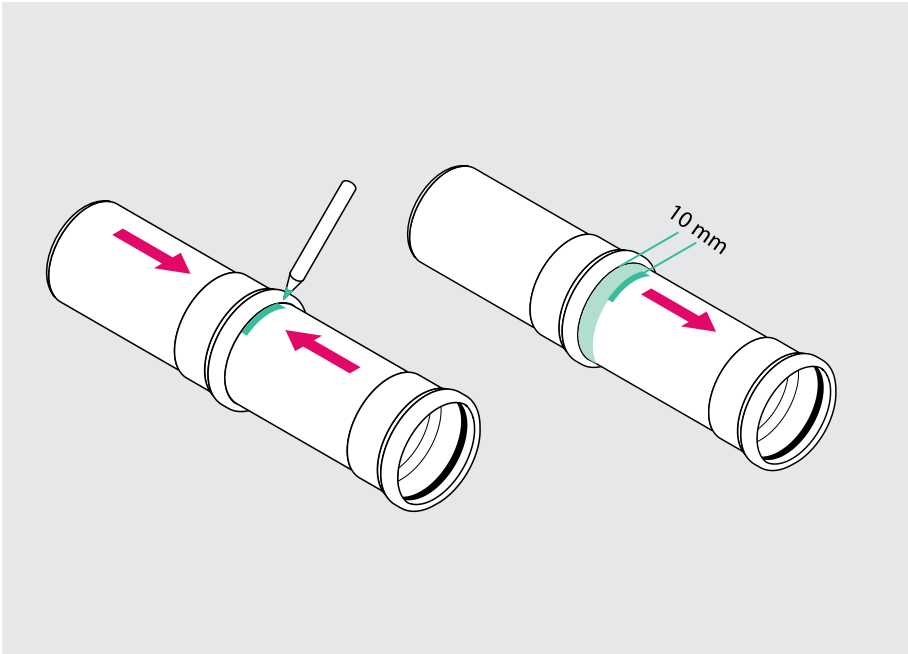

To accommodate thermal expansion of RAUPIANO system, the following conditions are recommended. Ensure witness mark is visible to ensure that the pipe is not accidentally pulled out.

### **Insert fully and pull out 10mm per pipe for:**

- Pipes longer than 500mm;

### **Insert spigot end fully into socket for:**

- Pipes shorter than 500mm;
- In ground applications;
- Fitting to fitting.

# RAUPIANO PLUS

## Pipe support - Brackets

### Bracket types

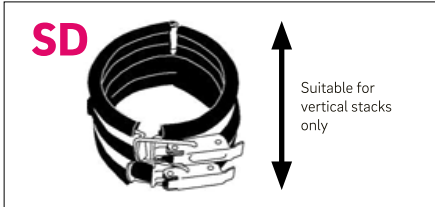

#### Sound-dampening bracket

- Minimizes transmission of vibrations from pipe through fixing into wall via acoustic de-coupling.
- Consists of loose and tight bracket:
  - lower bracket (loose) attaches to wall
  - upper bracket (tight) supports pipe.
  - attach to vertical stack only
  - 1 required per floor, per stack
  - REHAU proprietary

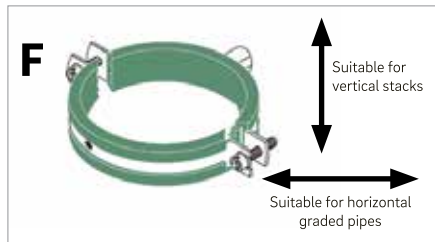

#### Fixing/security bracket

- Model: Walraven Bifix 5000 G2 (light green)
- This is the same model as Guiding bracket (above), however when used as a fixing/security bracket, it is to be installed with some spacers removed. See table on page 25 for full details.
- Always tight on pipe
- When used as fixing bracket on graded pipes: **fix to ceiling**
- When used as a security bracket in vertical stacks: install under and in contact with loose Sound Dampening Bracket on every third floor. **Never fix to wall.**

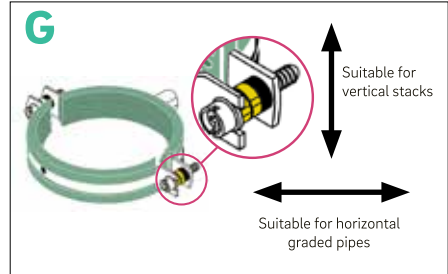











#### Guiding bracket

- Model: Walraven Bifix 5000 G2 (light green)
- This is the same model as fixing/security bracket (below), however when used as a guiding bracket, it is to be installed as received, with all spacers. See table in next page for full details.
- Allows for thermal expansion of the pipe
- Always loose on pipe.
- Fix to ceiling on graded pipes
- Fix to wall on vertical stack



# RAUPIANO PLUS

## Pipe support - Brackets

Pipe Size (DN)	Guiding Bracket	Fixing Bracket
40	 <p>Install as supplied – 2 spacers on each side (1 x brown and 1 x yellow)</p>	 <p><b>Remove:</b> 1 x yellow spacer from each side. <b>Install with only:</b> 1 x brown spacer on each side</p>
50	 <p>Install as supplied – 3 spacers on each side (2 x brown and 1 x yellow)</p>	 <p><b>Remove:</b> 1 x yellow spacer from each side. <b>Install with only:</b> 2 x brown spacers on each side</p>
75	 <p>Install as supplied – 3 spacers on each side (2 x yellow and 1 x green)</p>	 <p><b>Remove:</b> 1 x yellow spacer from each side. <b>Install with only:</b> 1 x yellow spacer and 1 x green spacer on each side</p>
110	 <p>Install as supplied – 3 spacers on each side (2 x yellow and 1 x green)</p>	 <p><b>Remove:</b> 1 x yellow spacer from each side. <b>Install with only:</b> 1 x yellow spacer and 1 x green spacer on each side</p>
160	 <p>Install as supplied – 3 yellow spacers on each side</p>	 <p><b>Remove:</b> 2 x yellow spacer from each side. <b>Install with only:</b> 1 x yellow spacer on each side</p>

**Note: Spacer installation has been depicted for one side of pipe only. This needs to be replicated on both sides of the pipe.**

# RAUPIANO PLUS

## Pipe support - Sound dampening bracket

The patented sound-dampening support bracket consists of a supporting bracket (loose) and a fastening bracket (tight, sits above supporting bracket). One sound-dampening support bracket per stack per floor is sufficient.



- Fit **fastening** bracket around the pipe and close it
- Ensure the taper of the fastening bracket is facing upwards



- Assemble **supporting** bracket to building structure
- Taper part of rubber facing up
- Round part of rubber facing down



- Open **supporting** bracket, insert pipe fitted with fastening bracket and close the supporting bracket
- Ensure the top supporting bracket rubber has the rounded end on the bottom which is supported in the taper of the fastening bracket



The **fastening** bracket rests on the supporting bracket to achieve optimum sound decoupling

**Note: Failure to install correctly may compromise acoustic performance**

# RAUPIANO PLUS

## Pipe support - Vertical stack

**SD** To be installed per stack per floor near the top  
 \*If there is no acoustic requirements, replace SD bracket with fixing bracket

**S** To be installed under the SD bracket every third floor  
 \*Installed tight onto pipe but not touching the wall

**G** To be installed per stack per floor near the bottom.  
 If the floor to ceiling height is  $\geq 4\text{m}$ , use an additional guiding bracket spaced 2m apart.

**Note: Install RAUPIANO stack from bottom to top**

- ✓
- Although it is good practice to install the sound-dampening bracket directly below the pipe socket, it is not necessary to do so as long as it is not installed on the socket itself.
  - The guiding bracket permits free longitudinal movement of RAUPIANO PLUS pipe.
  - For non acoustic installations, the sound dampening bracket can be replaced with a fixing/ security bracket.

**SD** - Sound-dampening bracket\*

**G** - Guiding bracket (loose)

**S** - Security bracket (tight)\*\*

**F** - Fixing bracket (tight)

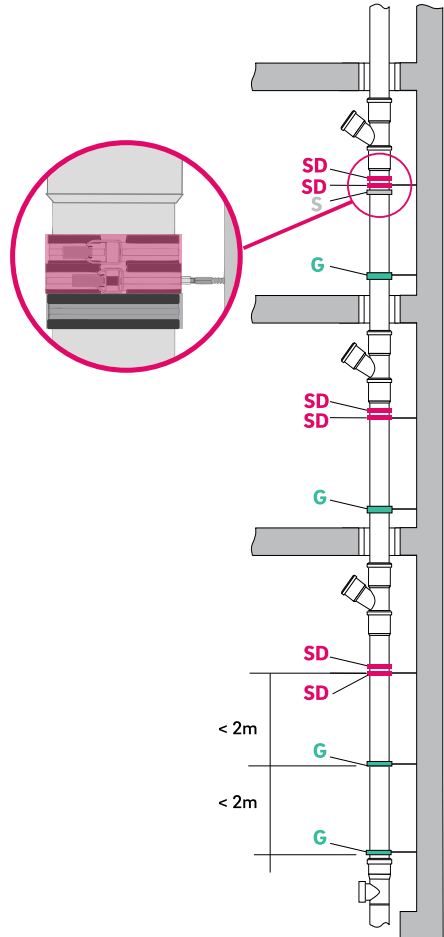

\* Magenta colour for illustration purposes only. Bracket colour is black.

\*\* Grey colour for illustration purposes only. Bracket colour is green.

# RAUPIANO PLUS

## Pipe support - Horizontal line

Fixing brackets hold the pipe in place. Guiding bracket allow for thermal expansion in one direction.

Pipe size (DN)	Collar OD (mm)	Pipe thickness (mm)	Pipe ID (mm)	Maximum recommended bracket spacing (mm)	Maximum bracket spacing according AS/ NZS 3500
40	52.8	1.8	36.4	15 x OD (600mm)	1000mm
50	62.8	1.8	46.4	15 x OD (750mm)	1000mm
75	87.9	1.9	71.2	15 x OD (1125mm)	1000mm
110	125.6	2.7	104.6	15 x OD (1650mm)	1000mm
160	180.7	3.9	152.2	15 x OD (2400mm)	1000mm

The REHAU recommended Maximum Bracketing space is an alternative solution to the requirements as described in AS/NZS 3500.

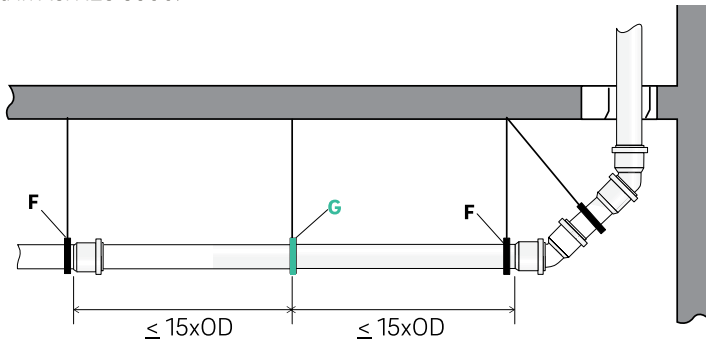

If fittings or obstructions prevent bracketing at 15 x D, reduce spacing.

- G** - Guiding bracket (loose)
- F** - Fixing bracket (tight)



- Don't use sound-dampening bracket on horizontal lines.
- Install fixing bracket at socket end followed by guiding brackets at the required spacing until next joint.
- Install fixing bracket downstream, as near as possible to the socket end.  
Do not install fixing bracket directly onto the socket.
- If more than 3 fittings are joined together in the same line, ensure the group of fittings are sufficiently supported to avoid sagging, twisting and to prevent the connections from sliding apart.
- It is recommended to have a bracket either side of a raised inspection opening.

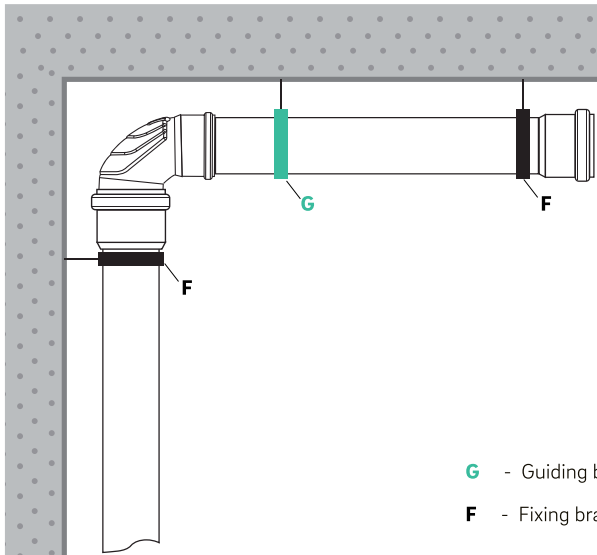

# RAUPIANO PLUS

## Pipe support - Anchor points

Anchor brackets are used when the distance between the ceiling and top of pipe is greater than 300mm.

Anchor brackets (ie. anchor points or tri-brackets) are required in the following applications:

### 1 For straight lines:

- Temperature  $<60^{\circ}\text{C}$  -  $L1 < 6\text{m}$
- Temperature  $>60^{\circ}\text{C}$  -  $L1 < 4\text{m}$

### 2 Install anchor brackets at changes in flow direction

### 3 For junctions:

- Temperature  $<60^{\circ}\text{C}$  and branch length ( $L2$ )  $>2\text{m}$  - Install anchor bracket on main line
- Temperature  $>60^{\circ}\text{C}$  and branch length ( $L2$ )  $>1\text{m}$  - Install anchor bracket on main line

### 4 Install anchor brackets at entry to stacks

### 5 Install anchor brackets after stack rolls

This is a recommended solution and not seismic tested.

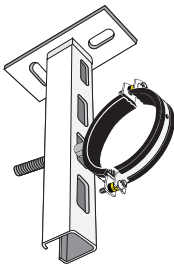
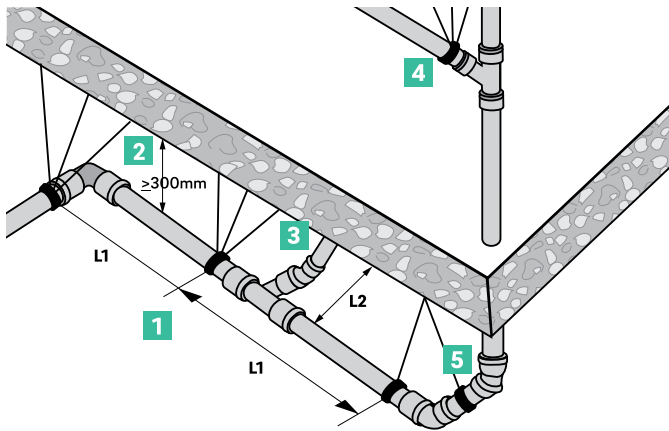

Fixed bracket with Unistrut

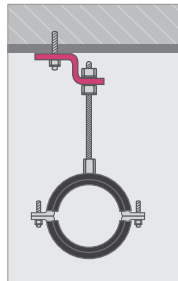

Z-brackets



Tri-brackets



Please consult with REHAU if you have any questions.

# RAUPIANO PLUS

## Inspection opening access pipe and pipe cap

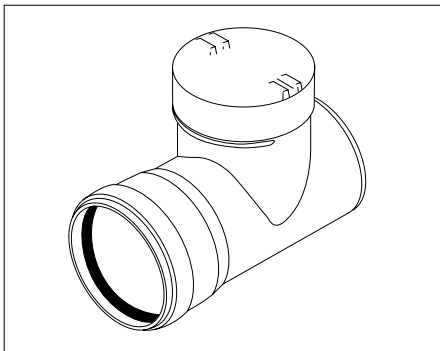

I.O. access pipe

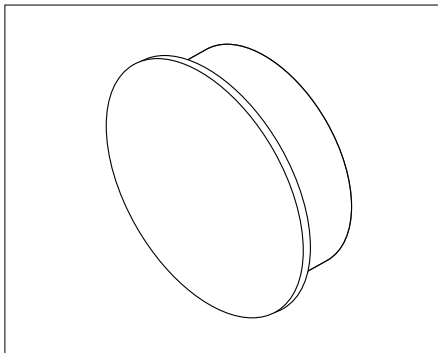

Pipe cap

- RAUPIANO PLUS I.O. access pipe is supplied with an insert to make the opening surface flush with the pipe inner diameter.
- The access cap has a threaded connection.
- The installation locations of inspection opening shall adhere to AS/NZS 3500.2.
- IO access pipe cannot be used to rise to surface.
- If this is required, use a DN110/87 deg junction art#1450921

- RAUPIANO PLUS pipe cap can be pushed into the socket.

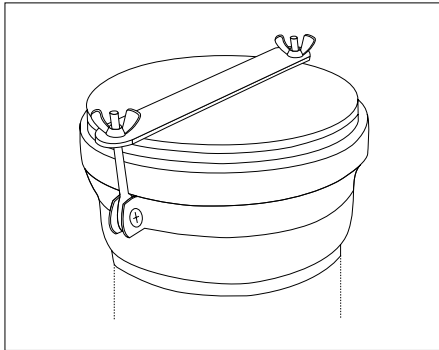

Securing clip

- To ensure that the pipe cap won't be pushed out by the water pressure within the piping system, a securing clip is required to be installed together with the pipe cap.

# RAUPIANO PLUS

## Push-fit lock

### RAUPIANO Push-Fit Lock

The RAUPIANO Push-Fit Lock increases the socket joint integrity by preventing the pipe from being pulled-out of the socket at higher load.

### Push-Fit Lock Application

- 1 Stormwater Downpipe installed inside buildings up to a maximum pressure of 2 bar (20 m).
- 2 Connection of Pump stations up to a maximum pressure of 2 bar
- 3 As an alternative solution, the Push-Fit Lock can be used to secure the socket plug, it would be used in replacement of using a securing clip.



Push-Fit Lock assembled on a socket

For Pump station applications, it is recommended to install the Push-Fit Lock around all sockets in horizontal and vertical pipework where the applied pump pressure may exceed 1 bar.

In stormwater applications it is recommended to install the Push-Fit Lock around all sockets in horizontal and vertical pipework in buildings of more than 10m in height.

In addition, the Push-Fit Lock can also be used to prevent the pipe from sliding apart during the installation phase.

It is easily installed and dismantled. The auto-locking assembly mechanism prevents it from falling off the pipe, even when the Push-Fit Lock has not been tightened yet.

Installation is simple, fast and secure. The necessary bolts and nuts are supplied together with the Push-Fit Lock.



# RAUPIANO PLUS

## Push-fit lock

### Required

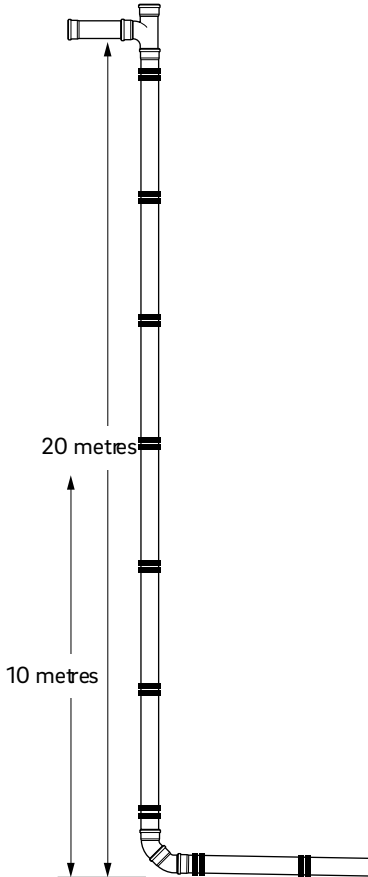

### Not required

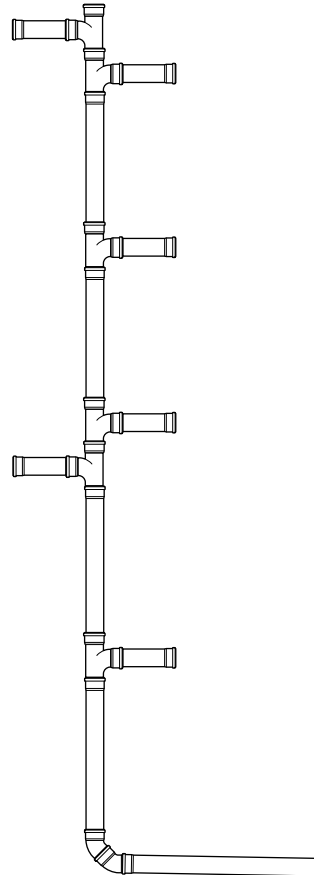

In drainage or stormwater applications, where there are NO branches, takeoffs or balcony drains and the effective stack height is between 10 - 20 metres, Push-fit locks must be installed in both horizontal and vertical pipework, up to the first takeoff or balcony drain.

# RAUPIANO PLUS

## P-trap siphon/110mm disconnecter gully

### P-trap siphon / 110mm disconnecter gully

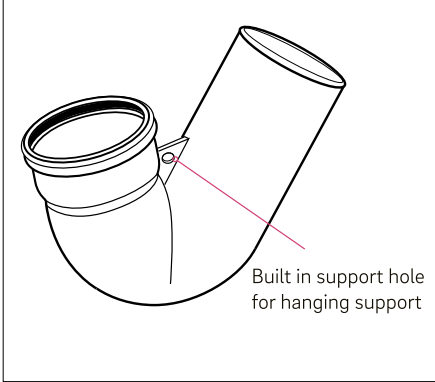

The P-trap siphon can be supported by attaching a hook or suitable nut clip for 10mm threaded rod into the built-in support hole.

RAUPIANO PLUS P-trap siphon provides a 50 mm water seal to prevent foul odour from coming out of the drainage lines. The P-trap siphon is to be used in conjunction with a DN/OD 110 45° bend.

When installing this P-trap, it is important to install the pipe support properly to ensure safe operation of the drainage system.

If bracketing at the built-in support hole is not possible due to space constraints, the P-trap can be supported from below by using a rubber-lined bracket at the bottom. Vertical rods are used to connect the bracket to the concrete slab above. Please see image below as an example.

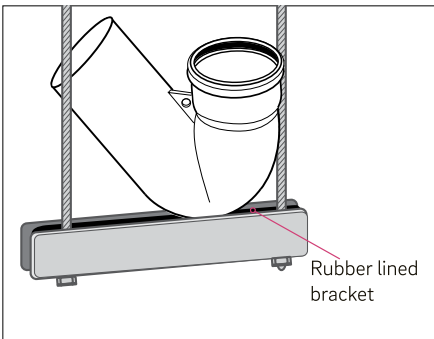

This image is purely for illustrative purposes and is not intended to satisfy the installation requirements of any particular project.

This image does not depict other components commonly installed with the P-trap."

# RAUPIANO PLUS

## Floor waste gully - installation

### RAUPIANO PLUS - floor waste gully features:

- 3-way riser (DN 110 floor inlet, 3 x DN50 inlets, DN75 outlet).
- Integrated water seal without use of baffle.
- The same push-fit joining method applies for all the inlets and outlet.

#### 1. Drill hole for required inlets using 44mm hole saw

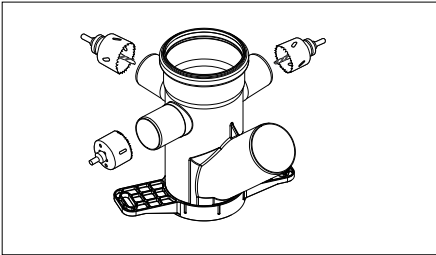

Floor waste gully with supporting bracket, art. no 108971-001

Note: Only 45° bend should be attached to DN75 outlet. If using 90° bend, it must be attached facing downwards only, and must not be attached facing sideways.

Attaching a 90° bend facing sideways will cause the outlet to be higher than the FWG inlet, preventing flow of water through the FWG. See images below.

#### 2. Assemble double socket over DN50 inlets and 45° bend over DN75 outlet\*

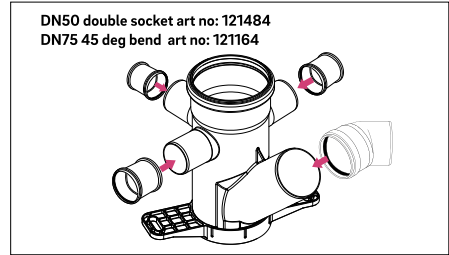

Floor waste gully with double sockets on inlets and 45° bend on outlet

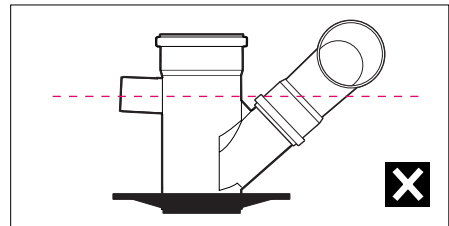
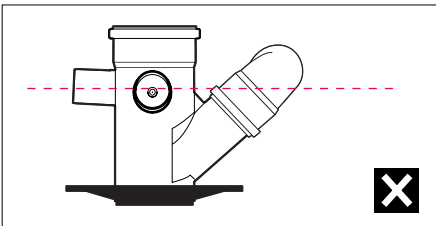
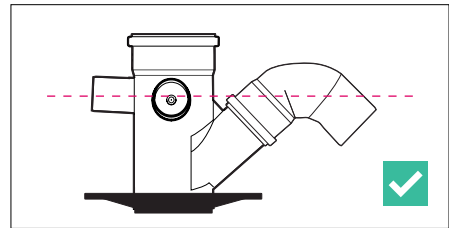
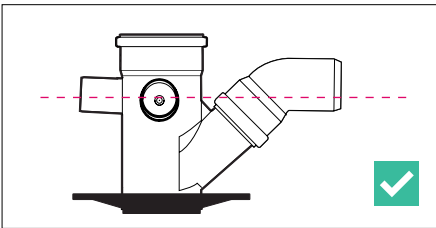

## Floor Waste Gully - Bracketing schematic diagram only

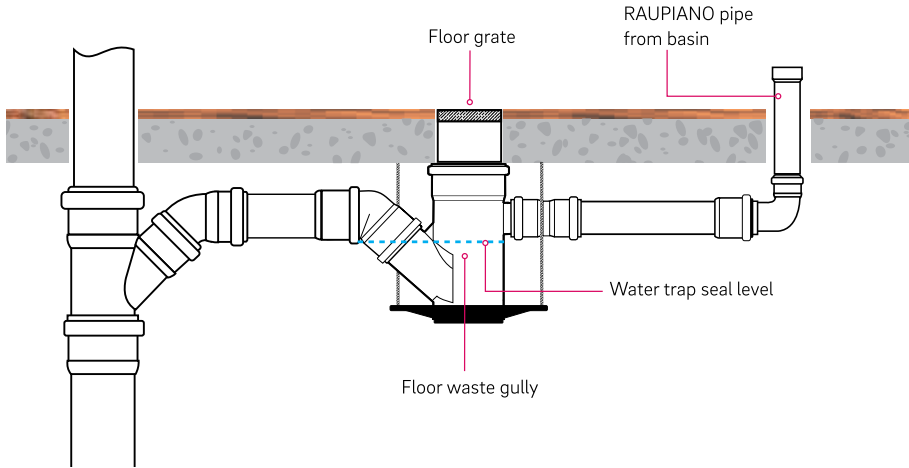

**3. Install floor waste gully beneath slab by inserting over DN110 riser pipe.**

**4. Install socket of DN75 outlet pipe over DN 75 45° bend spigot.**

**5. Install DN50 inlet pipe into double socket of each inlet to be used.**

**6. Secure floor waste gully to slab using threaded rods with bottom bracket.**



This schematic shows a general example of connecting the Floor Waste Gully's bracket to the concrete slab only, and is not intended to satisfy the installation requirements for any particular project. Fire collars, puddle flanges and other necessary components are not depicted in this schematic, but normal requirements for these remain. Normal requirements to hold the pipework in place also remain. For the installation of the Floor Waste Gully and RAUPIANO PLUS waste water piping system, national and local codes, rules and regulations, as well as local conditions and the demands of the end use customer, and REHAU's RAUPIANO PLUS Technical Information available on [www.rehau.com.au](http://www.rehau.com.au) need to be considered.

# RAUPIANO PLUS

## Installation advice

- A** To reduce structure-borne noise and improve the acoustic performance of the drainage system, avoid direct contact between pipe and ceiling/wall materials by installing insulation layer within the penetration.

When fire collars are used, check with the respective fire collar manufacturer on tested solutions of insulation layers that can be used to prevent sound transmission.

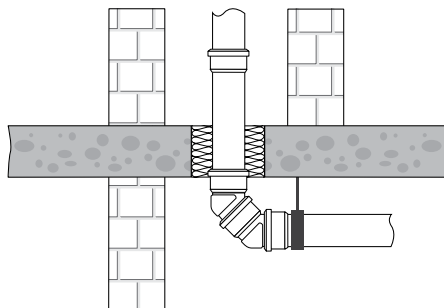

- B** Wrap the drainage line with closed-cell insulation to avoid condensation, especially for storm-water application condensation may occur on the pipe surface. It is recommended to wrap all pipework where condensation could occur with closed-cell insulation materials.

- C** For commercial kitchen with grease separator located at a distance, install pipe heat trace to prevent premature grease accumulation. Max. heat trace temperature is 65°C.

# RAUPIANO PLUS

## Connection to PVC pipe

If it is necessary to adapt to PVC systems which are manufactured according to AS/NZS 1260, the simple adaptor from RAUPIANO PLUS to PVC system is available.

To install these adaptors, please adhere the following steps:

- apply primer and solvent cement to the PVC side of the adaptor
- insert the solvent-cemented portion into a female socket of PVC fitting
- apply REHAU lubricant to the other portion of the adaptor and insert into RAUPIANO PLUS socket

These adaptors are made of PVC and available for the following sizes:

PVC adaptor	From RAUPIANO PLUS	OD (mm)	PVC system	To OD (mm)
DN 40/40	DN 40	40	DN 40	43
DN 50/40	DN 50	50	DN 40	43
DN 50/50	DN 50	50	DN 50	56
DN 75/50	DN 75	75	DN 50	56
DN 75/65	DN 75	75	DN 65	69

Available adaptor sizes from RAUPIANO PLUS to PVC system

\* For RAUPIANO sizes DN 110 and DN 160 a PVC adaptor is not required as they have the same OD as PVC.

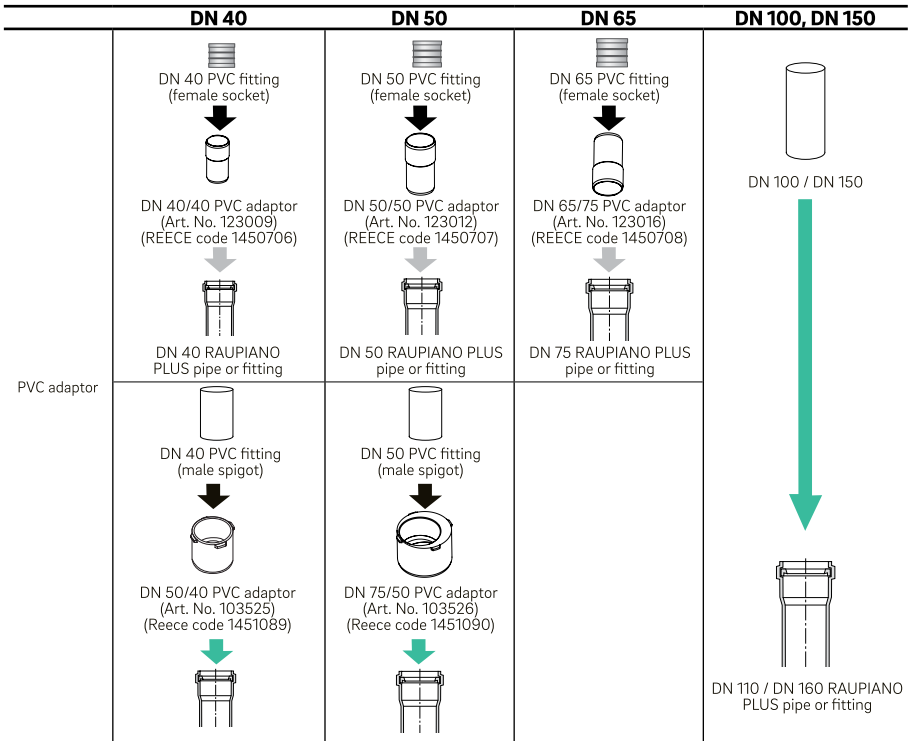

# RAUPIANO PLUS

## Connection to other metal or plastic pipe

### Drainage fittings to RAUPIANO PLUS

There are several options for connecting plumbing fixture drainage fittings or other pipe materials to RAUPIANO plus drainage pipes or fittings:

- RAUPIANO PLUS connection pipe
- RAUPIANO PLUS connection bend
- RAUPIANO PLUS fitting with beaded rubber nipple

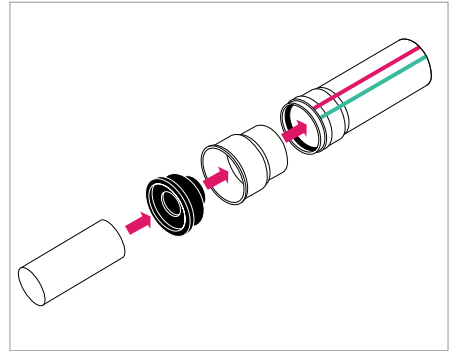

- 1 Insert rubber nipple in the socket of the connection pipe.
- 2 Apply REHAU lubricant on the sealing lips of the rubber nipple.
- 3 Insert male end of drain fitting of plumbing fixture into the rubber nipple.

	DN 40	DN 50	DN 50
Fixture trap			
	 OD 32 - 40 mm metal pipe	 OD 32 - 40 mm metal pipe	 OD 47 - 50 mm metal pipe
	 DN 50/40 rubber nipple (Art. No. 126253) (REECE code 1450882)	 DN 50/40 rubber nipple (Art. No. 126253) (REECE code 1450882)	 DN 50/50 rubber nipple (Art. No. 121913) (REECE code 1450883)
	 DN 40/40 connection pipe (Art. No. 123164) (REECE code 1450752)	 DN 50/40-30 connection pipe (Art. No. 121414) (REECE code 1450753)	 DN 50/50 connection pipe (Art. No. 121424) (REECE code 1450754)
	 DN 40 RAUPIANO PLUS pipe or fitting	 DN 50 RAUPIANO PLUS pipe or fitting	 DN 50 RAUPIANO PLUS pipe or fitting

### RAUPIANO PLUS fitting with beaded rubber nipple

- 1 Remove the existing, standard sealing ring from the pipe or fitting socket.
- 2 Insert rubber nipple with bead into the fitting socket.
- 3 Insert male end of the drain fitting of plumbing fixture into the rubber nipple.

For connection from other pipe system to RAUPIANO PLUS, for example from metal/ plastic P- or S-trap

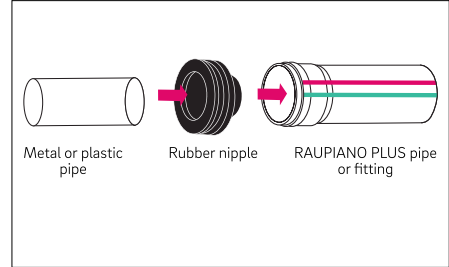

	DN 40	DN 50	DN 50
Fixture trap 	 OD 32 mm metal pipe	 OD 32 mm metal pipe	 OD 40 mm metal pipe
	 DN 40/30 rubber nipple with bead (Art. No. 122923) (REECE code 1450884)	 DN 50/30 rubber nipple with bead (Art. No. 122933) (REECE code 1450885)	 DN 50/40 rubber nipple with bead (Art. No. 122943) (REECE code 1450886)
	 DN 40 RAUPIANO PLUS pipe or fitting (without rubber ring)	 DN 50 RAUPIANO PLUS pipe or fitting (without rubber ring)	 DN 50 RAUPIANO PLUS pipe or fitting (without rubber ring)

Drainage fittings to RAUPIANO PLUS adaption



# RAUPIANO PLUS

## Connection to cast iron

### Rubber sleeve adaptor for Cast Iron pipe or other materials



Rubber sleeve for same or different outer diameters.

Below are the properties of the rubber sleeve adaptor.

Material	EPDM
Tightening device	Stainless-steel worm-gear clamps
Recommended tightening torque	3 Nm (Newton metres)
Pressure resistance	1 bar
Chemical resistance	pH 2 - 12

### Installation steps:

1. Insert RAUPIANO PLUS pipe end into one end of the rubber sleeve adaptor.
2. Insert Cast Iron / other material pipe end into the other end of the rubber sleeve adaptor.
3. Tighten the worm-gear clamps on both ends of the rubber sleeve adaptor without exceeding the maximum tightening torque.

For transition from RAUPIANO PLUS pipes to Cast Iron pipes or other materials for drainage systems, rubber sleeve adaptors can be used. These rubber sleeves come with rubber seal that is attached to the pipe ends and two stainless-steel worm-gear clamps. These rubber sleeve adaptors can be used in new construction or renovation works.

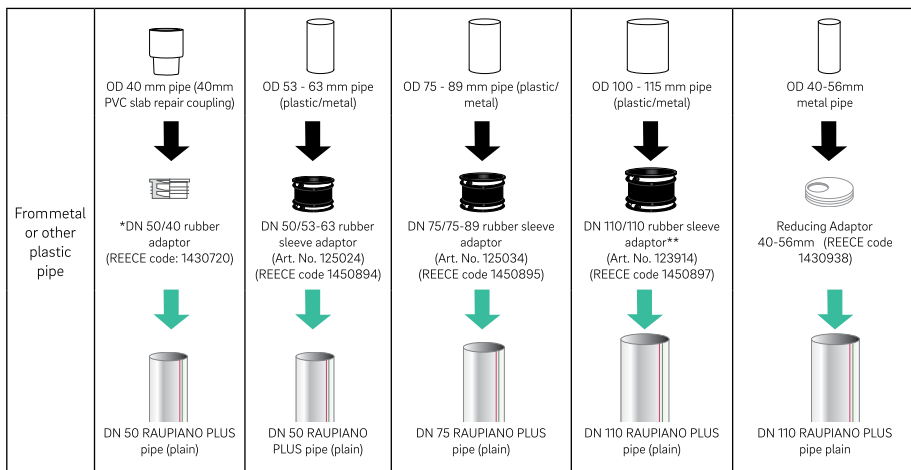

Metal and other pipe to RAUPIANO PLUS adaption

\*Fits inside pipe

\*\* Contact REHAU for further information

# RAUPIANO PLUS

## Leak test



The leak test must be carried out in accordance with AS/NZS 3500.2

For pipes installed below ground, testing shall be conducted prior to the placement of the trench fill (backfill).

### Hydrostatic test

The sanitary plumbing and sanitary drainage shall be filled with water -

- (a) in the case of sanitary drainage, to a height of not less than 1m above the pipe soffit level at the highest point of the section being tested;
- (b) in the case of sanitary plumbing, to the spill level of the highest fixture or to the flood level of the lowest sanitary fixture, whichever is higher; and
- (c) in the case of pipe installed below ground, to a height not less than 2 m (or 20 kPa ) above the pipe soffit level at the highest point of the section being tested or 2 m (or 20 kPa ) above ground water table, whichever is the greater.

The pressure shall be maintained without leakage for at least 15 min. The source of any leak shall then be ascertained and any defects repaired. The section under test shall then be retested.

### Air Test

Alternatively, the test can be carried out with air.

The air test is carried out with:

- Test pressure 15 kPa

- 1 Ensure firm and sealed seating of plugs.
- 2 Pipes ends should be secured with securing clips (see page 12) or push-fit locks
- 3 Pressurise the system and stabilize for a minimum of 3 minutes while checking for leaks
- 4 After pressure is stabilized commence the test by allowing the pressure to reduce to 10 kPa
- 5 Start test time and record drop in pressure during the test time
- 6 The section of sanitary plumbing or sanitary drainage being tested shall not have a drop in pressure greater than 3 kPa over the minimum test duration specified in Table 10.1

Pipe size	Test Length (m)					
	50	100	150	200	250	300
DN	Minimum test duration, min					
110	2	2	2	2	3	3
160	3	3	3	6	6	6

Minimum test duration for Air Test in minutes

# RAUPIANO PLUS

## Fire protection solutions

RAUPIANO PLUS system can be installed with suitable fire collars which have been tested and proven according to AS 1530.4 to fulfill the fire protection requirements from NCC/BCA.

Approved fire collar solutions for RAUPIANO PLUS pipe are available from the following manufacturers:

- Promat (1800 776 628 or [www.promat.com.au](http://www.promat.com.au))
- Snap (1300 76 46 26 or [www.snapcollars.com.au](http://www.snapcollars.com.au))
- Hilti (131 292 or [www.hilti.com.au](http://www.hilti.com.au))
- Allproof (+64 9 481 8020 or <http://allproof.co.nz>)

**IMPORTANT: Not every fire collar is tested and approved with RAUPIANO PLUS**

Contact the manufacturer of the fire collar for information on fire test results and assembly/installation instructions to determine which solution suits your requirements.

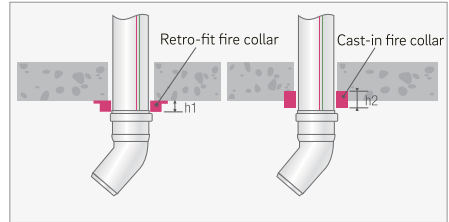

Installation of fireproof collar in ceiling\*

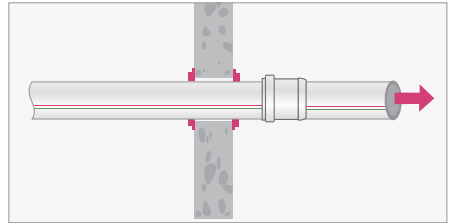

Installation of fireproof collar on wall\*

\* The above schematics show general examples and are not intended to satisfy the installation requirements for any particular project. Specific fire protection measures may or may not be required depending on building class and design, check with fire engineer and refer to the National Construction Code for detailed information.

\* Floor waste gully fire collars may be different. Please check with fire collar manufacturer.

# RAUPIANO PLUS

## Overview

<b>Material</b>	PP-MD mineral-reinforced (pipes and fittings)	
<b>Size range</b>	DN 40 – DN 160	
<b>Area of application</b>	Waste water pipes in buildings and laid below ground inside and outside the building structure	
<b>Chemical resistance</b>	Polypropylene basis No waste water containing mineral oil or benzene Seals made of EPDM	in accordance with DIN 8078  DIN 4060, DIN EN 681-1
	Refer to RAUPIANO PLUS Installation and Technical Manual for chemical resistance data	
<b>Application</b>	<p>Waste water with ph value 2 – 12</p> <p>Waste water temperature up to 98°C (brief periods*)</p> <p>Installation temperature down to -10°C</p> <p>Maximum head pressure 1 bar (10m) respectively 2 bar (20m) when using Push-fit Lock.</p> <p>Design Service Life 50 years within these application parameters.</p>	
<b>Standards and approval System test according to:</b>	<ul style="list-style-type: none"> <li>- AS/NZS 7671, WM70060</li> <li>- AS 2887, WM71501</li> <li>- AS/NZS 1260, WM71502</li> <li>- AS/NZS 5065, WM71503</li> </ul>	
<b>System assessed according to:</b>	<ul style="list-style-type: none"> <li>- BRANZ Appraisal No. 809</li> <li>- Best Environmental Practice PVC to AS/NZS 1260</li> </ul>	

\* Refer to RAUPIANO Technical Information for further details on discharge temperatures and rates.









**REHAU Pty Ltd**

National Customer Service Centre

**Australia**

Tel: 1300 768 033 • Fax: 1300 760 665

Email: [sales.au@rehau.com](mailto:sales.au@rehau.com)

[www.rehau.com.au](http://www.rehau.com.au)

**New Zealand**

Tel: +64 9 272 2264

Email: [sales.nz@rehau.com](mailto:sales.nz@rehau.com)

[www.rehau.co.nz](http://www.rehau.co.nz)

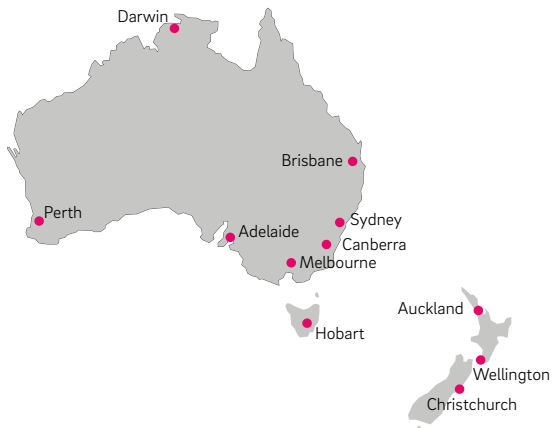

The information contained herein is believed to be reliable, but no representations, guarantees or warranties of any kind are made as to its accuracy, suitability for particular applications or the results to be obtained therefrom. Before using, the user will determine suitability of the information for user's intended use and shall assume all risk and liability in connection therewith.