

# EURO-DESIGN 70

TECHNICKÉ INFORMACE  
TVARY PROFILŮ



# EURO-DESIGN 70

## TVARY PROFILŮ

### Obsah

Rámové profily . . . . .	2
Sloupky-Poutce-Příčky . . . . .	9
Vyrovnávací profily . . . . .	11
Křídlové profily . . . . .	12
Profily pro dvoukřídla okna bez pevných sloupků . . . . .	16
Příslušenství pro mechanické spojení . . . . .	19
Příslušenství pro dveřní napojení . . . . .	22
Vrtací šablony . . . . .	25
Příslušenství pro rám pro panelové domy . . . . .	26
Armování . . . . .	27
Seznam artiklů . . . . .	31
Vysvětlivky značek . . . . .	34

# EURO-DESIGN 70

## TVARY PROFILŮ

### Rámové profily

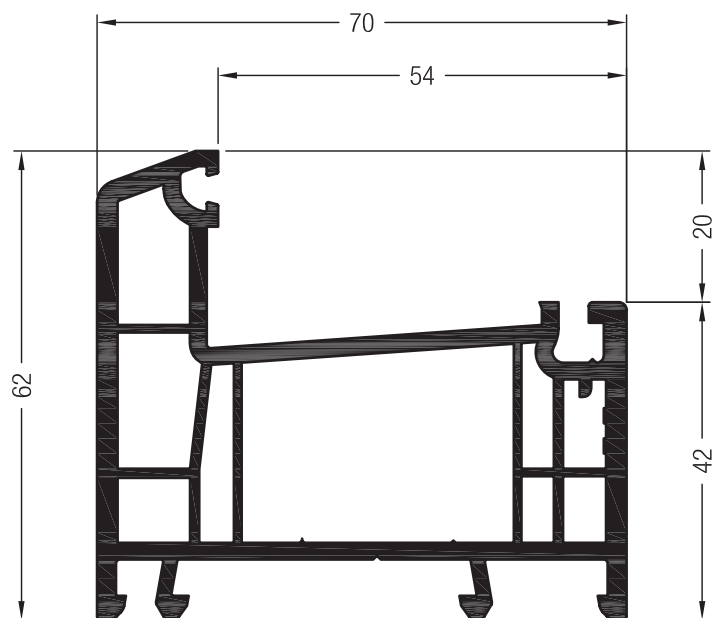





Rám 62 ED70

550800 

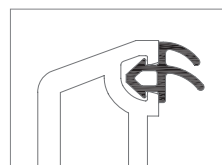
 576



Zasklívací těsnění - viz.  
Směrnice pro zasklívání

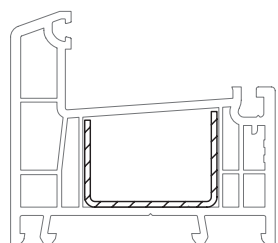

	<b>864952</b>
	<b>865530</b>
	<b>835171</b>



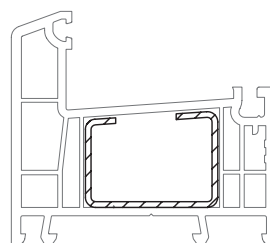

35 x 25,3 x 23

	<b>355520@</b>
	1,5
lx	2,4
ly	0,72
	6



35 x 25,3

	<b>355470</b>
	1,5
lx	2,7
ly	1,2
	6

# EURO-DESIGN 70

## TVARY PROFILŮ

### Rámové profily

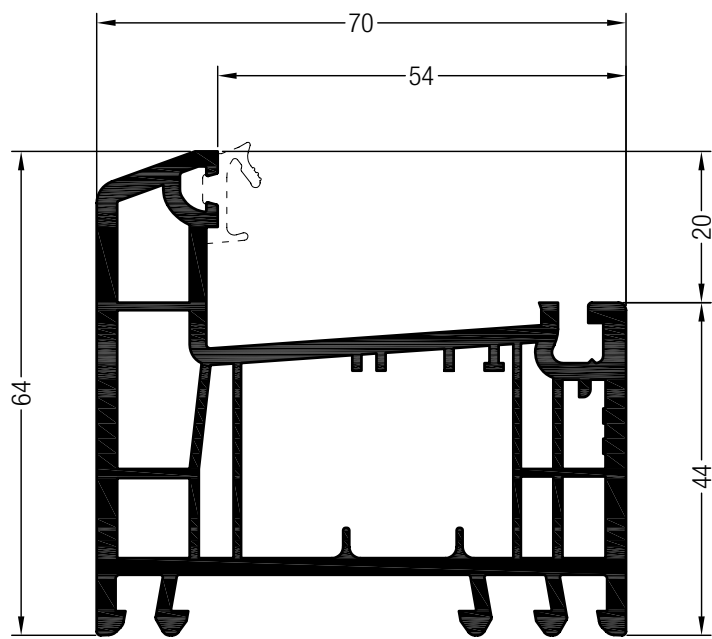

Rám 64 ED70

550003 

599003 



 36

550333  

 36

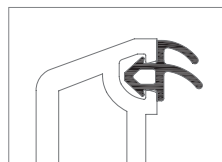

Zasklívací těsnění - viz.  
Směrnice pro zasklívání

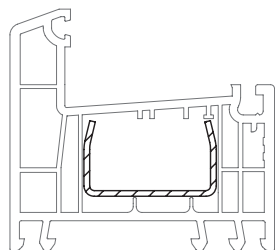

	864952
	865530
	835171



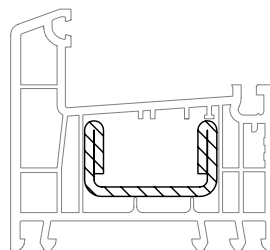

35 x 20

	<b>351103</b>
	1,5
lx	2,0
ly	0,42
	6



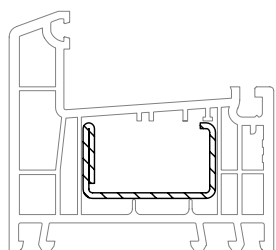

35 x 20

	<b>245526</b>
	2,5
lx	4,2
ly	0,9
	6



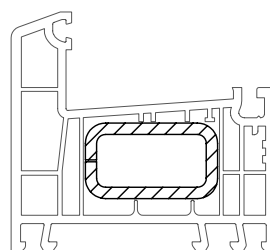

35 x 20

	<b>261831</b>	<b>261841</b>
	1,5	2
lx	2,5	3,1
ly	0,56	0,69
	6	6



35 x 20

	<b>239583</b>	<b>261709 @</b>
	1,5	2
lx	2,3	2,9
ly	0,98	1,2
	6	6

# EURO-DESIGN 70

## TVARY PROFILŮ

### Rámové profily

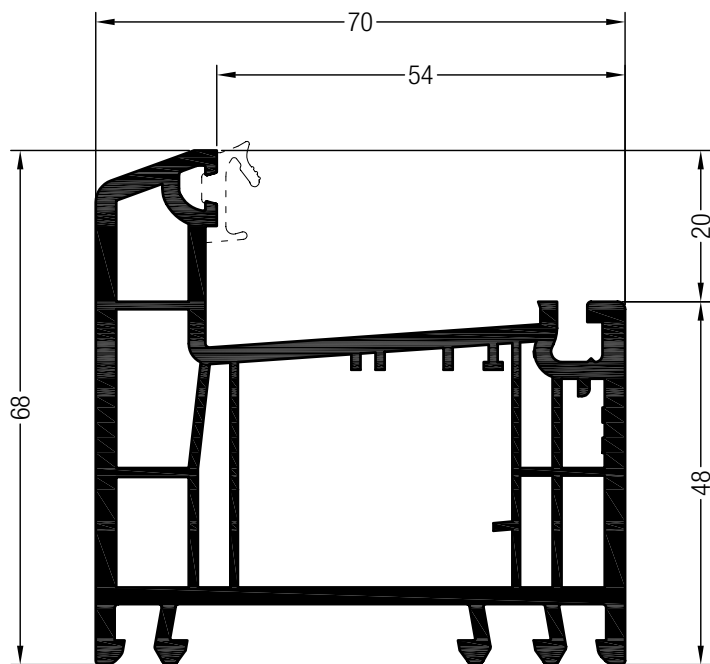

Rám 68 ED70

550713 

599713 

 36



550733  

599733  

 36

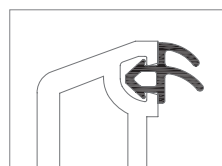

Zasklívací těsnění - viz.  
Směrnice pro zasklívání

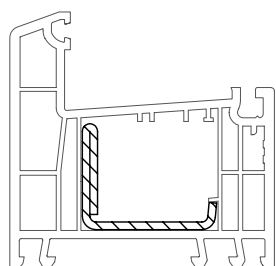

	864952
	865530
	835171



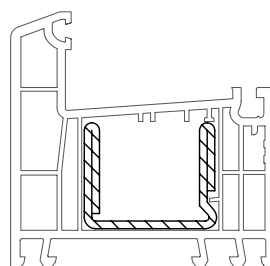

35,5 x 28

	<b>244546</b>
	2
lx	2,2
ly	1,3
	6



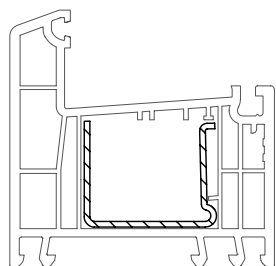

35 x 28

	<b>244536</b>
	2
lx	5,0
ly	2,0
	6



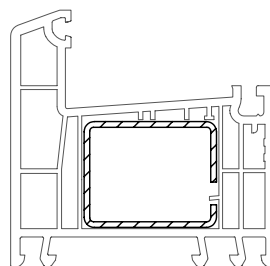

35 x 28

	<b>244506</b>
	1,5
lx	2,5
ly	1,1
	6



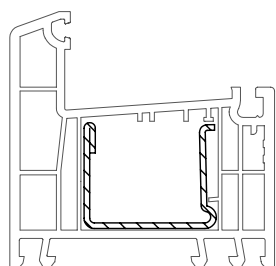

35 x 28

	<b>237091</b>	<b>249934</b>
	1,5	2
lx	2,8	3,4
ly	2,1	2,6
	6	6



35 x 28

	<b>244516</b>	<b>244526</b>
	1,5	2
lx	2,7	3,5
ly	1,3	1,7
	6	6

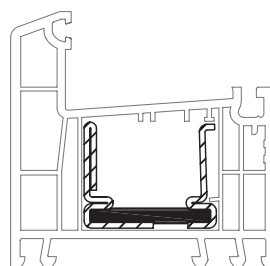

35 x 28

	<b>233134</b>
	1,5
	6

# EURO-DESIGN 70

## TVARY PROFILŮ

### Rámové profily

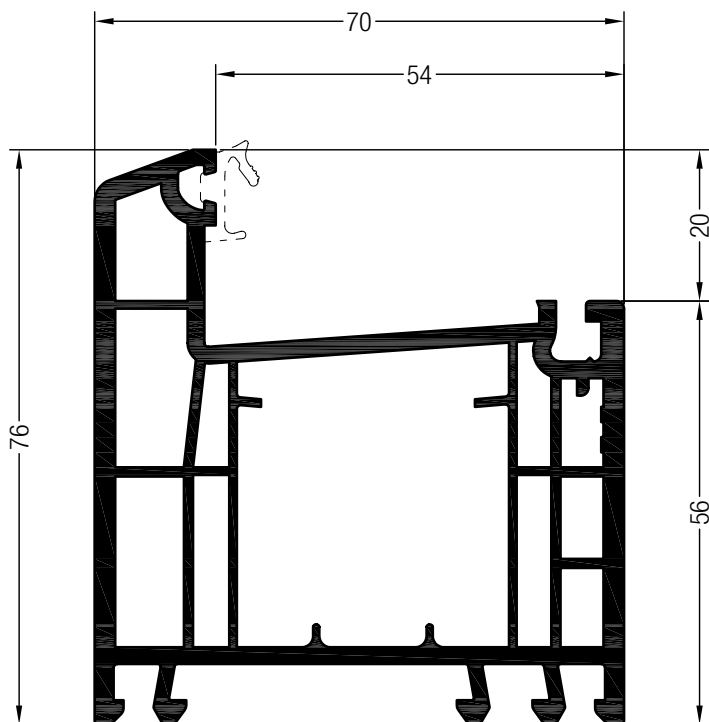

Rám 76-2 ED70

550761

599761

36

550763

599763

36

Zasklívací těsnění - viz.  
Směrnice pro zasklívání

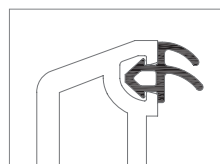

	864952
	865530
	835171

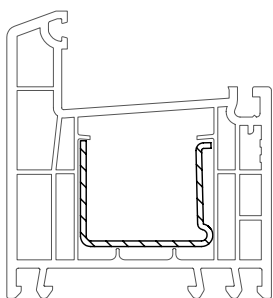

35 x 28	
	<b>244506</b>
	1,5
lx	2,5
ly	1,1
	6

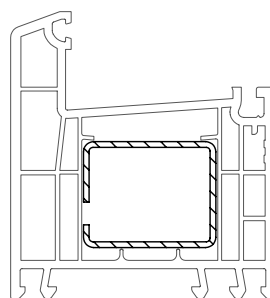

35 x 28		
	<b>237091</b>	<b>249934</b>
	1,5	2
lx	2,8	3,4
ly	2,1	2,6
	6	6

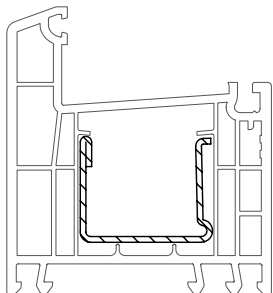

35 x 28		
	<b>244516</b>	<b>244526</b>
	1,5	2
lx	2,7	3,5
ly	1,3	1,7
	6	6

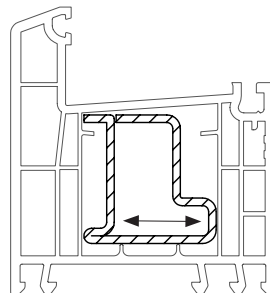

35 x 34	
	<b>227167</b>
	2
lx	2,7
ly	3,9
	6

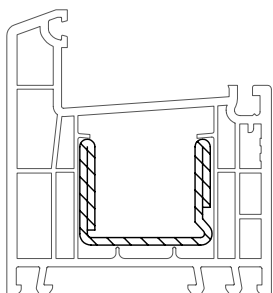

35 x 28	
	<b>244536</b>
	2
lx	5,0
ly	2,0
	6

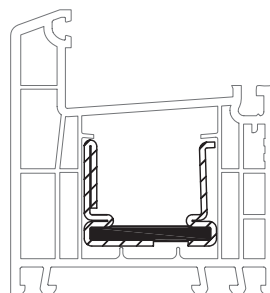

35 x 28	
	<b>233134</b>
	1,5
	6

# EURO-DESIGN 70

## TVARY PROFILŮ

### Rámové profily

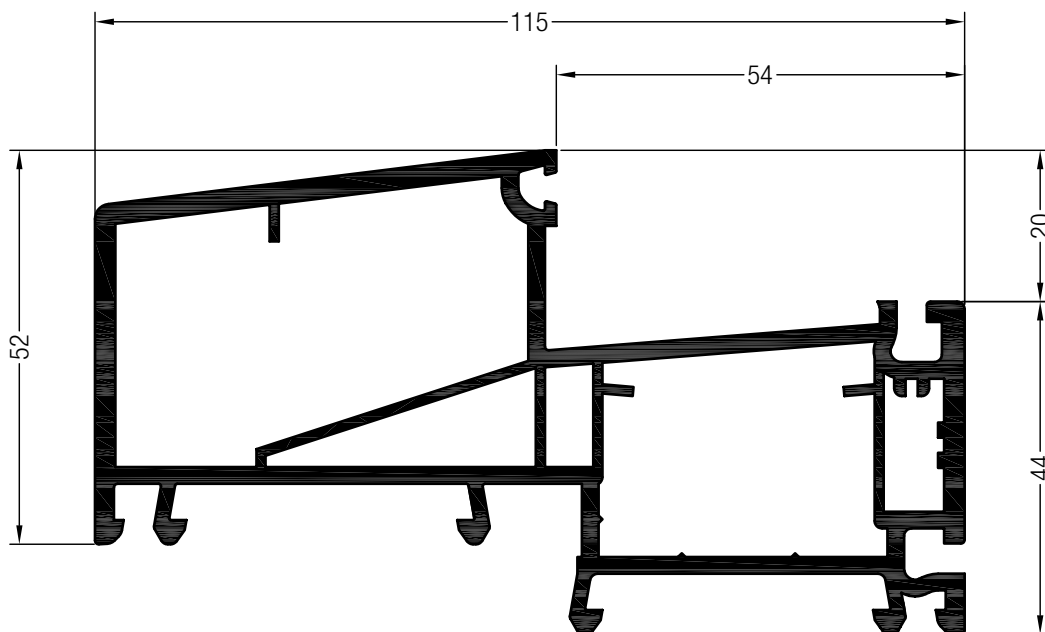



Rám pro panelové domy  
Rám 115-4K ED70

550131 

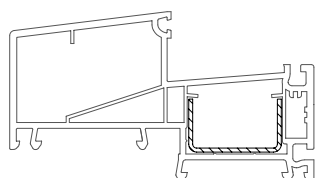
 12



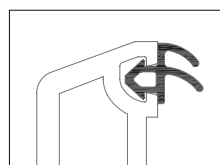

35 x 20

	245536	
	1,5	
lx	2,0	
ly	0,42	
	6	





Zasklívací těsnění - viz.  
Směrnice pro zasklívání

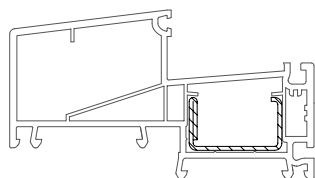

	864952
	865530
	835171



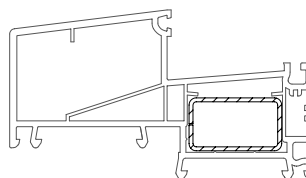

35 x 20

	261831	261841
	1,5	2
lx	2,5	3,1
ly	0,56	0,69
	6	6



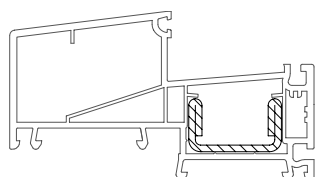

35 x 20

	239583	261709 @
	1,5	2
lx	2,3	2,9
ly	0,98	1,2
	6	6



35 x 20

	245526
	2,5
lx	4,2
ly	0,9
	6



# EURO-DESIGN 70

## TVARY PROFILŮ

### Rámové profily

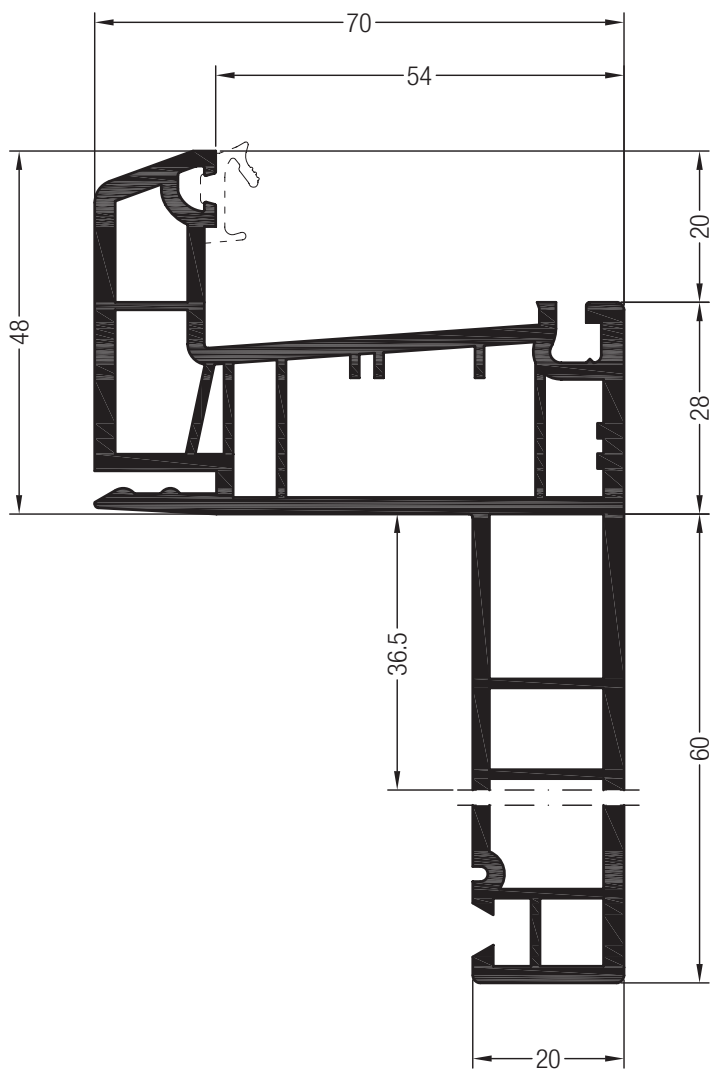

Rám pro rekonstrukce 37 ED70

550999 @

504

599999 @

24

Rám pro rekonstrukce 60 ED70

550990 @

24

550995 @

504

599995 @

24

Zasklívací těsnění - viz.  
Směrnice pro zasklívání

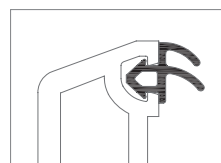

	864952
	865530
	835171

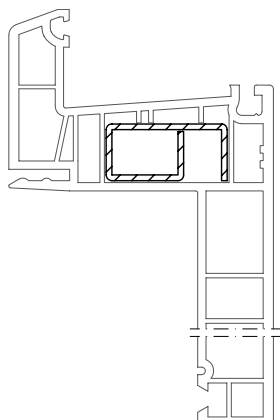

32 x 15

	<b>283312</b>
	1,5
lx	1,5
ly	0,41
	6

# EURO-DESIGN 70

## TVARY PROFILŮ

### Rámové profily

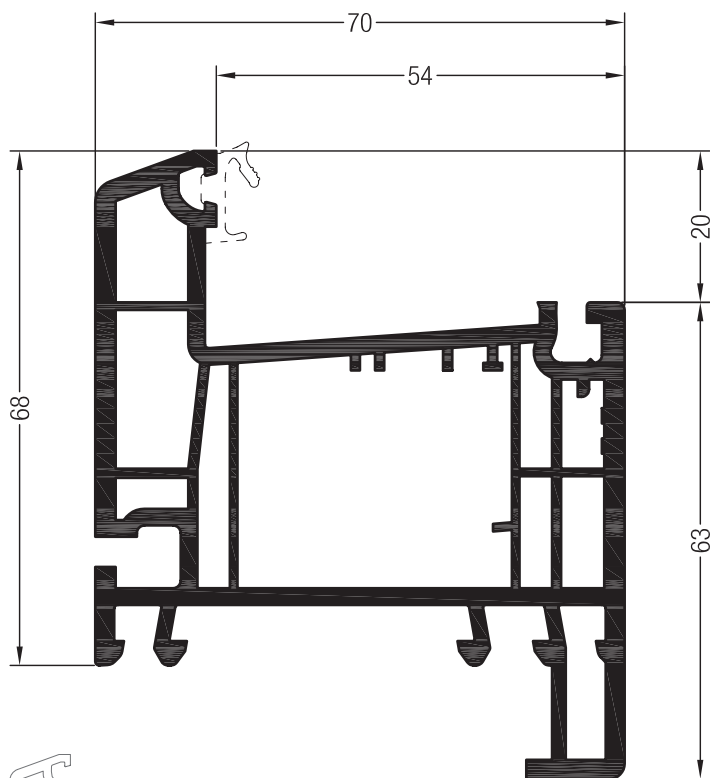

Základní rám 68 ED70

550913 @

599913 @

36

550933 @

36

599933 @

24

Zasklívací těsnění - viz.  
Směrnice pro zasklívání

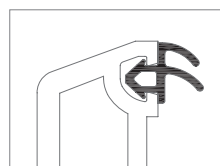

	864952
	865530
	835171

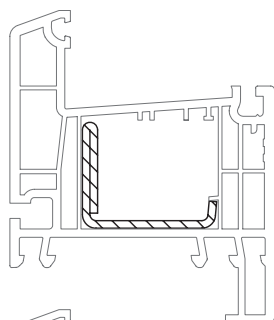

35,5 x 28

	<b>244546</b>
	2
lx	2,2
ly	1,3
	6

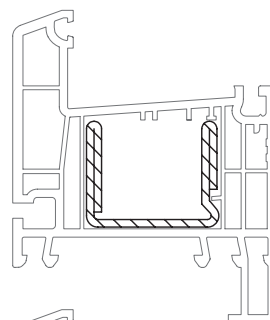

35 x 28

	<b>244536</b>
	2
lx	5,0
ly	2,0
	6

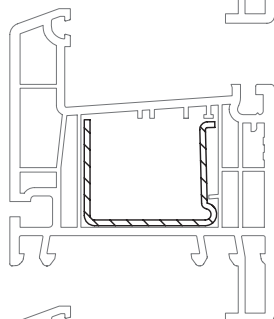

35 x 28

	<b>244506</b>
	1,5
lx	2,5
ly	1,1
	6

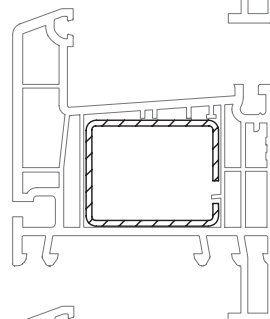

35 x 28

	<b>237091</b>	<b>249934</b>
	1,5	2
lx	2,8	3,4
ly	2,1	2,6
	6	6

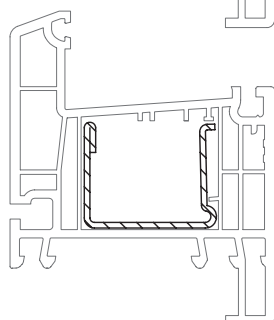

35 x 28

	<b>244516</b>	<b>244526</b>
	1,5	2
lx	2,7	3,5
ly	1,3	1,7
	6	6

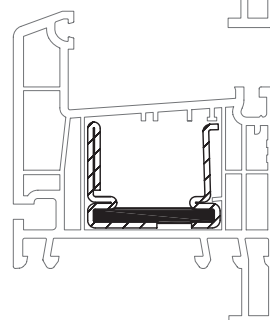

35 x 28

	<b>233134</b>
	1,5
	6

# EURO-DESIGN 70

## TVARY PROFILŮ

### Sloupky-Poutce-Příčky

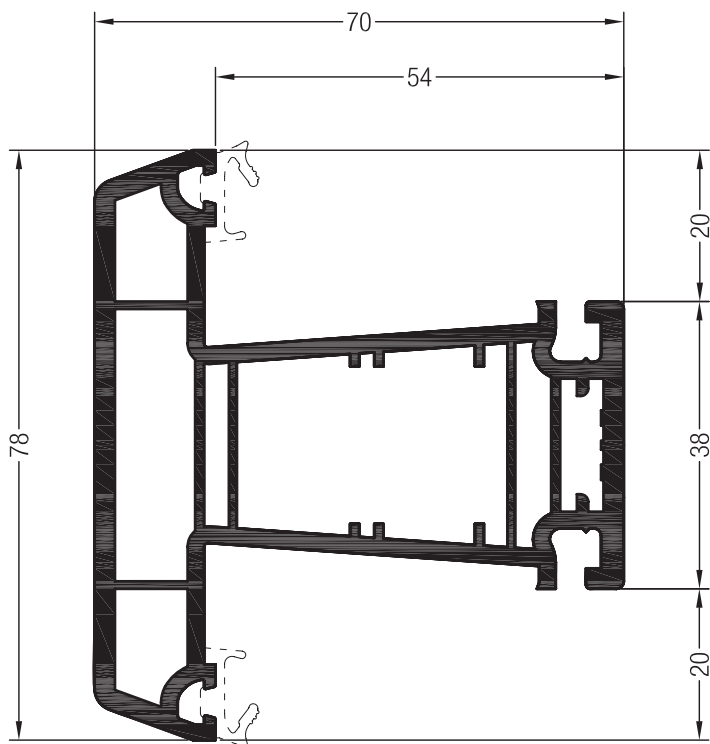

Sloupek 78 ED70

550613

599613

36

550633 @

36

Zasklívací těsnění - viz.  
Směrnice pro zasklívání

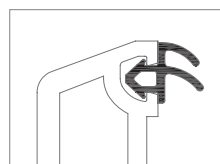

	<b>864952</b>
	<b>865530</b>
	<b>835171</b>

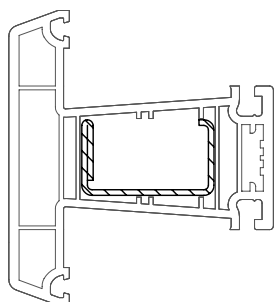

35 x 20

	<b>261831</b>	<b>261841</b>
	1,5	2
lx	2,5	3,1
ly	0,56	0,69
	6	6

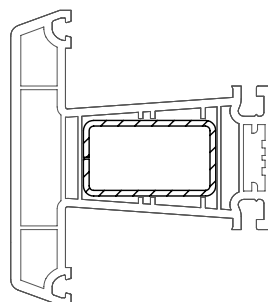

35 x 20

	<b>239583</b>	<b>261709 @</b>
	1,5	2
lx	2,3	2,9
ly	0,98	1,2
	6	6

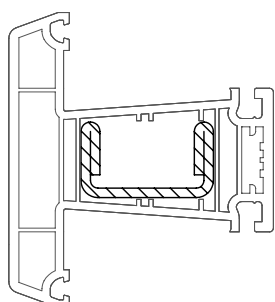

35 x 20

	<b>245526</b>
	2,5
lx	4,2
ly	0,9
	6

# EURO-DESIGN 70

## TVARY PROFILŮ

### Sloupky-Poutce-Příčky

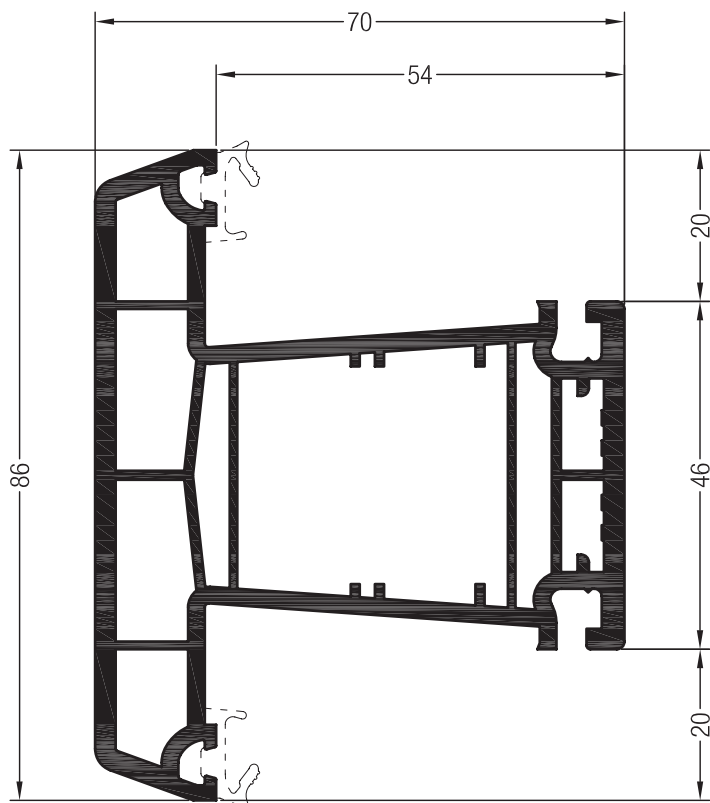

Sloupek 86 ED70

550813

599813

36

550833

599833

36

Zasklívací těsnění - viz.  
Směrnice pro zasklívání

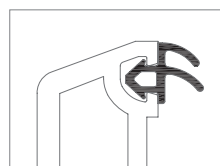

	864952
	865530
	835171

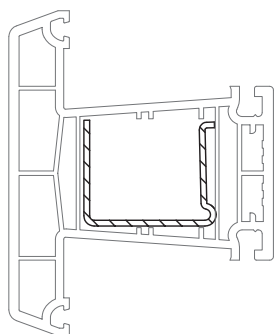

35 x 28

	<b>244506</b>	
	1,5	
lx	2,5	
ly	1,1	
	6	

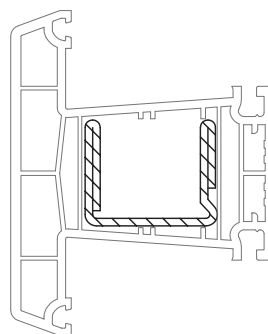

35 x 28

	<b>244536</b>	
	2	
lx	5,0	
ly	2,0	
	6	

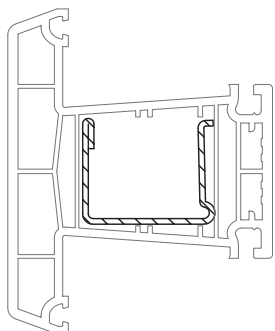

35 x 28

	<b>244516</b>	<b>244526</b>
	1,5	2
lx	2,7	3,5
ly	1,3	1,7
	6	6

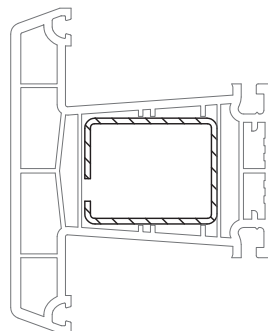

35 x 28

	<b>237091</b>	<b>249934</b>
	1,5	2
lx	2,8	3,4
ly	2,1	2,6
	6	6

# EURO-DESIGN 70

## TVARY PROFILŮ

### Vyrovnávací profily

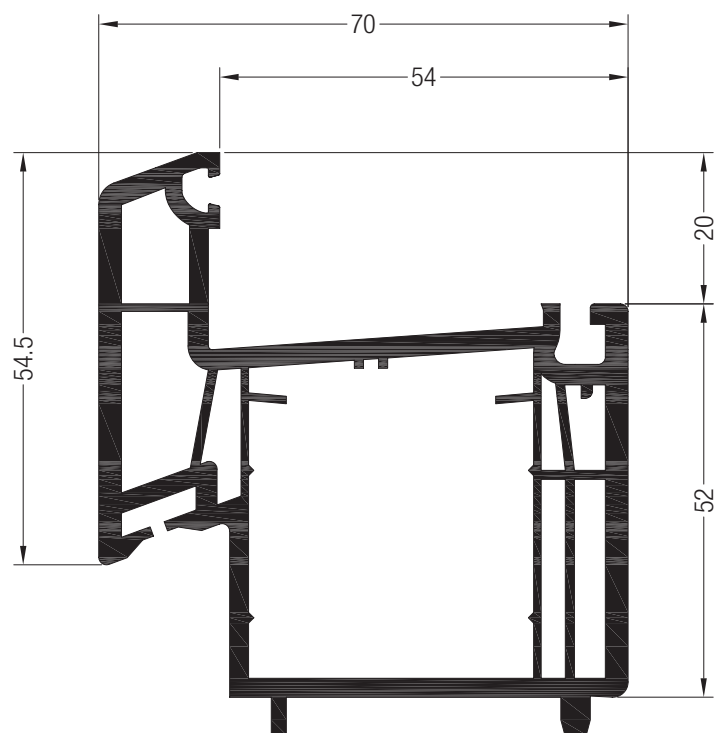

Vyrovnávací profil 54 konstrukční hloubky 70  
(ve spojení se 60 mm křídlem)

550490 

599490  @

 24

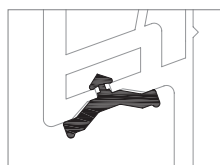

Zasklívací těsnění - viz.  
Směrnice pro zasklívání

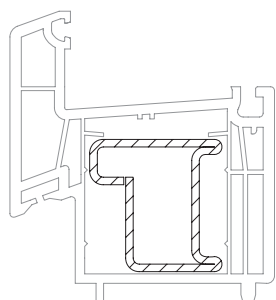

 865910



35 x 34

	<b>227167</b>
	2
lx	2,7
ly	3,9
	6

# EURO-DESIGN 70

## TVARY PROFILŮ

### Křídlové profily

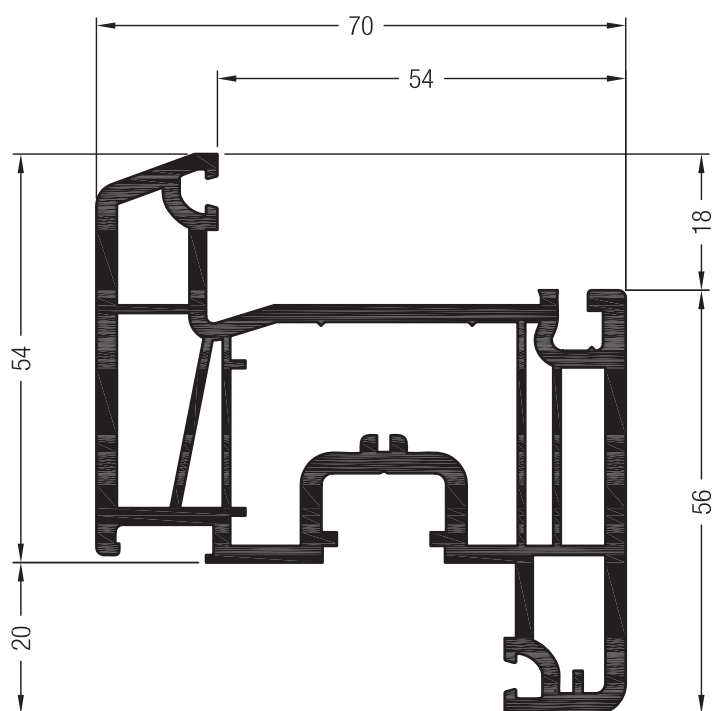





Křídlo Z54 ED70

550810 

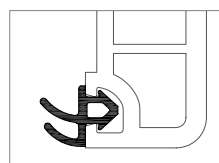
 576



Zasklívací těsnění - viz.  
Směrnice pro zasklívání

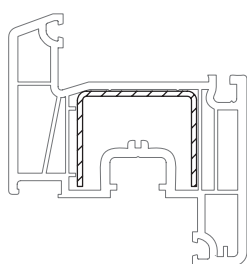

	<b>864952</b>
	<b>865530</b>
	<b>835171</b>



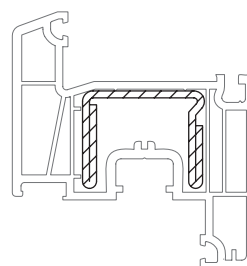

35 x 28

	<b>355480@</b>
	1,5
lx	2,7
ly	1,1
	6



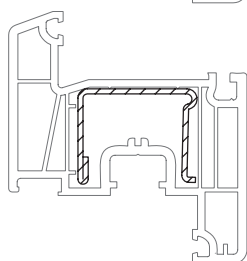

35 x 28

	<b>244536</b>
	2
lx	5,0
ly	2,0
	6



35 x 28

	<b>244516</b>	<b>244526</b>
	1,5	2
lx	2,7	3,5
ly	1,3	1,7
	6	6

# EURO-DESIGN 70

## TVARY PROFILŮ

### Křídlové profily

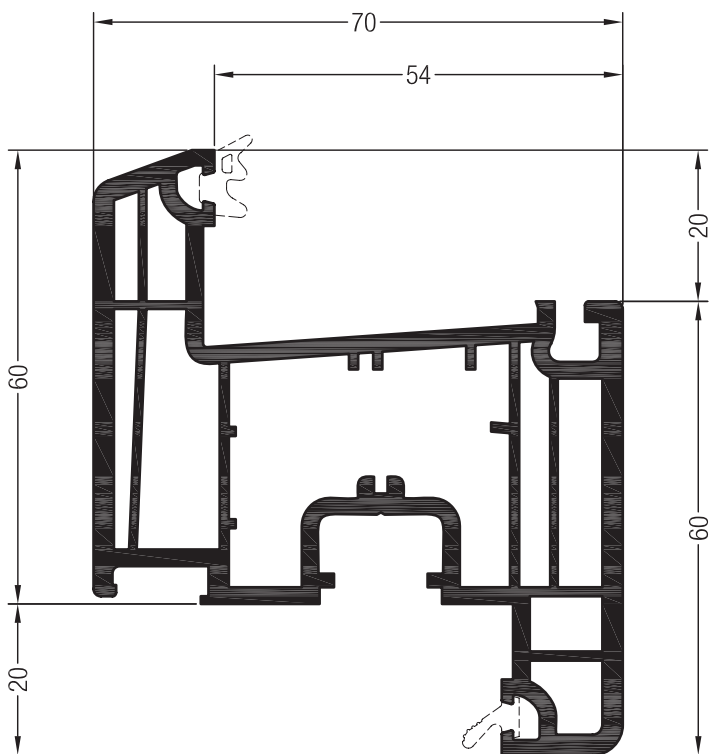

Křídlo Z60 ED70

550413

24

599413

36

550433

599433

24

Zasklívací těsnění - viz.  
Směrnice pro zasklívání

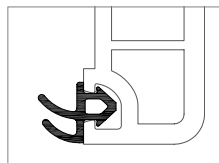

	864952
	865530
	835171

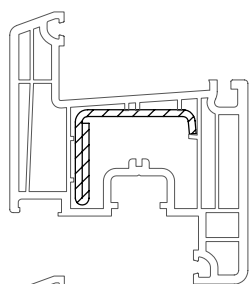

35,5 x 28

	<b>244546</b>
	2
lx	2,2
ly	1,3
	6

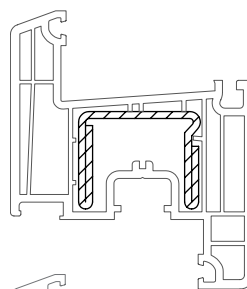

35 x 28

	<b>244536</b>
	2
lx	5,0
ly	2,0
	6

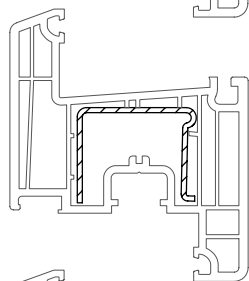

35 x 28

	<b>244506</b>
	1,5
lx	2,5
ly	1,1
	6

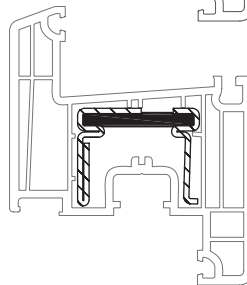

35 x 28

	<b>233134</b>
	1,5
	6

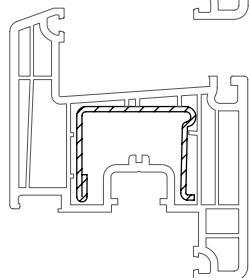

35 x 28

	<b>244516</b>	<b>244526</b>
	1,5	2
lx	2,7	3,5
ly	1,3	1,7
	6	6

# EURO-DESIGN 70

## TVARY PROFILŮ

### Křídlové profily

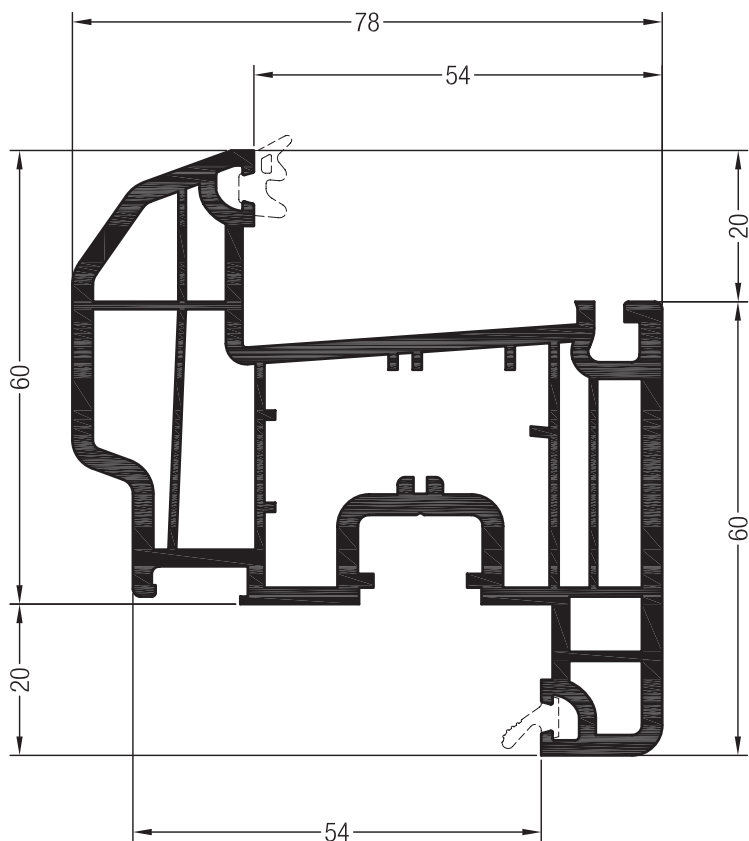

Křídlo A60 ED70

550051

599051

36

550351

24

599351

36

Zasklívací těsnění - viz.  
Směrnice pro zasklívání

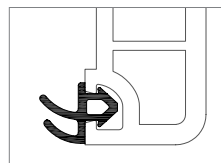

	864952
	865530
	835171

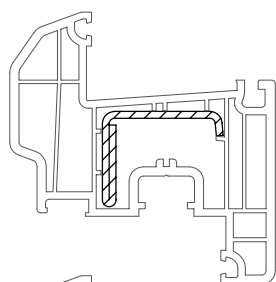

35,5 x 28

	<b>244546</b>
	2
lx	2,2
ly	1,3
	6

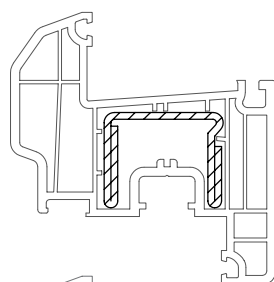

35 x 28

	<b>244536</b>
	2
lx	5,0
ly	2,0
	6

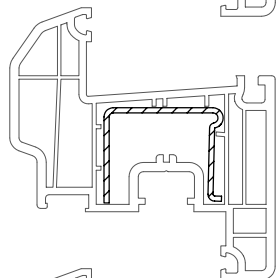

35 x 28

	<b>244506</b>
	1,5
lx	2,5
ly	1,1
	6

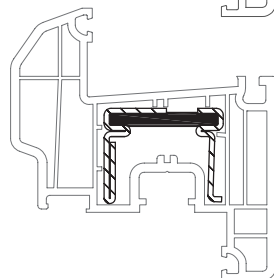

35 x 28

	<b>233134</b>
	1,5
	6

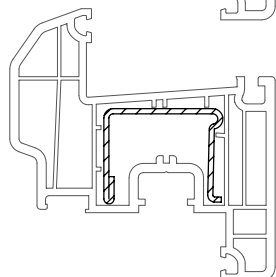

35 x 28

	<b>244516</b>	<b>244526</b>
	1,5	2
lx	2,7	3,5
ly	1,3	1,7
	6	6



# EURO-DESIGN 70

## TVARY PROFILŮ

### Křídlové profily

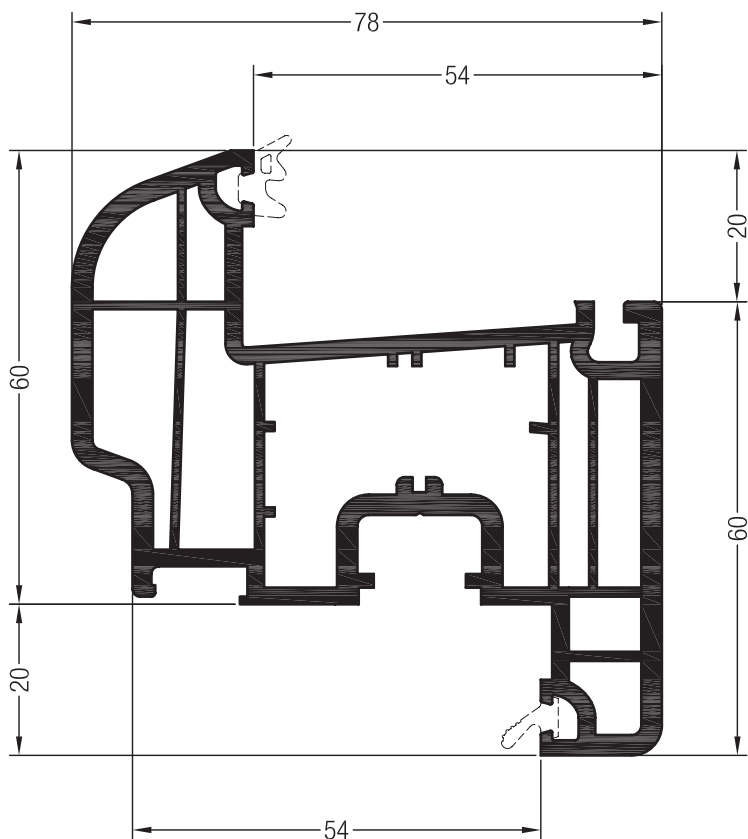

Křídlo 60 oblé ED70

550460

599461

36

550463

599463

24

Zasklívací těsnění - viz.  
Směrnice pro zasklívání

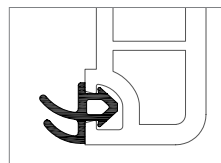

	864952
	865530
	835171

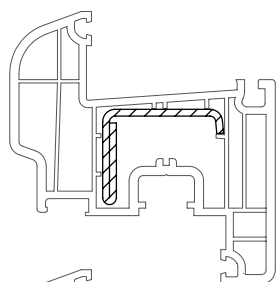

35,5 x 28

	<b>244546</b>
	2
lx	2,2
ly	1,3
	6

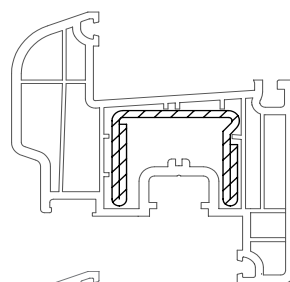

35 x 28

	<b>244536</b>
	2
lx	5,0
ly	2,0
	6

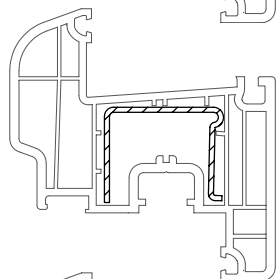

35 x 28

	<b>244506</b>
	1,5
lx	2,5
ly	1,1
	6

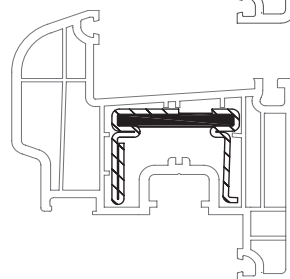

35 x 28

	<b>233134</b>
	1,5
	6

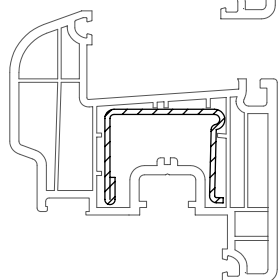

35 x 28

	<b>244516</b>	<b>244526</b>
	1,5	2
lx	2,7	3,5
ly	1,3	1,7
	6	6

# EURO-DESIGN 70

## TVARY PROFILŮ

Profily pro dvoukřídla okna bez pevných sloupků

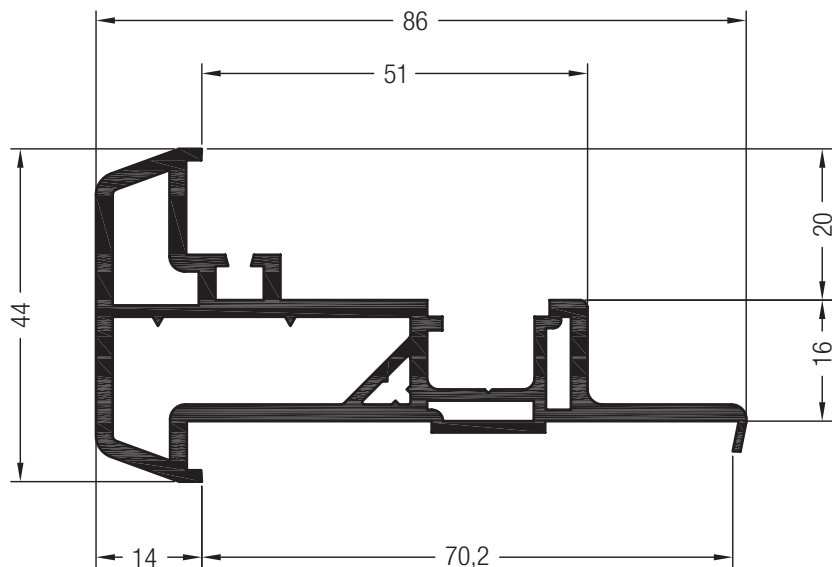





Klapačka konstrukční hloubky 70

550080 

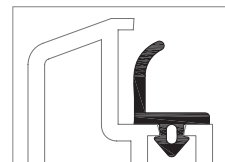
599080 



 36

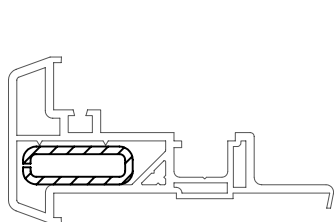

	864940
	865650
	835181



29 x 10

	<b>241620</b>
	2
lx	1,1
ly	0,18
	6

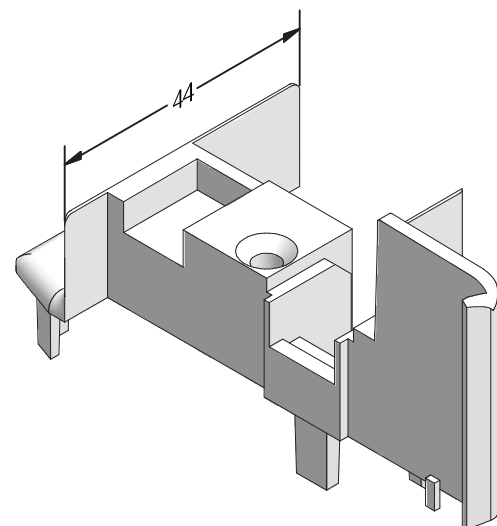

Koncovka pro klapačku konstrukční hloubky 70

RAU-ASA

222787   

222797   

 50

# EURO-DESIGN 70

## TVARY PROFILŮ

Profily pro dvoukřídla okna bez pevných sloupků

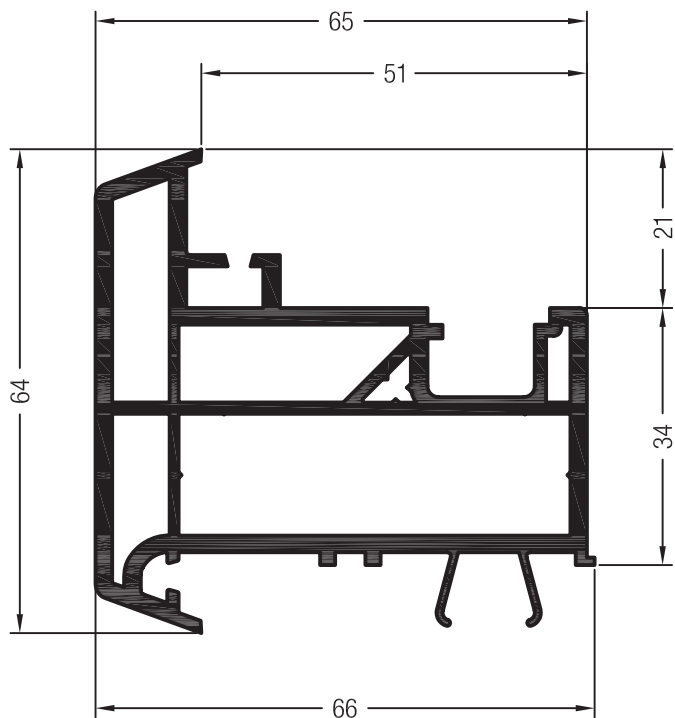

Statická klapačka konstrukční hloubky 70



550770 

 36

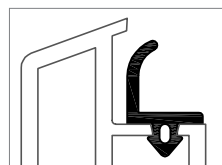

599770 

 24



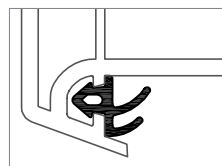

	864940
	865650
	835181

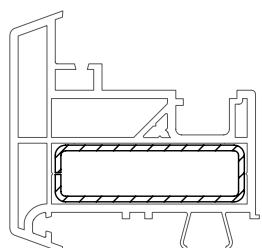

	864952
	865530
	835171



50 x 15

	<b>222065</b>
	1,5
lx	4,9
ly	0,7
	6

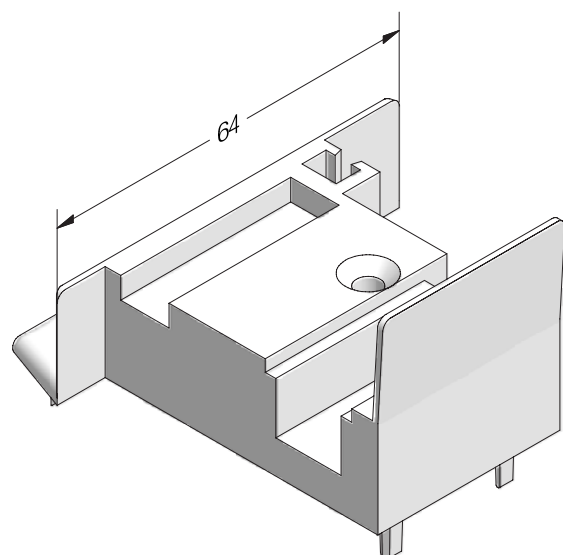

Koncovka pro statickou klapačku konstrukční hloubky 70

RAU-ASA

221590    

221600    

 50

# EURO-DESIGN 70

## TVARY PROFILŮ

Profily pro dvoukřídla okna bez pevných sloupků

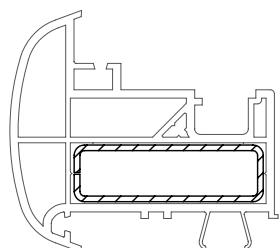
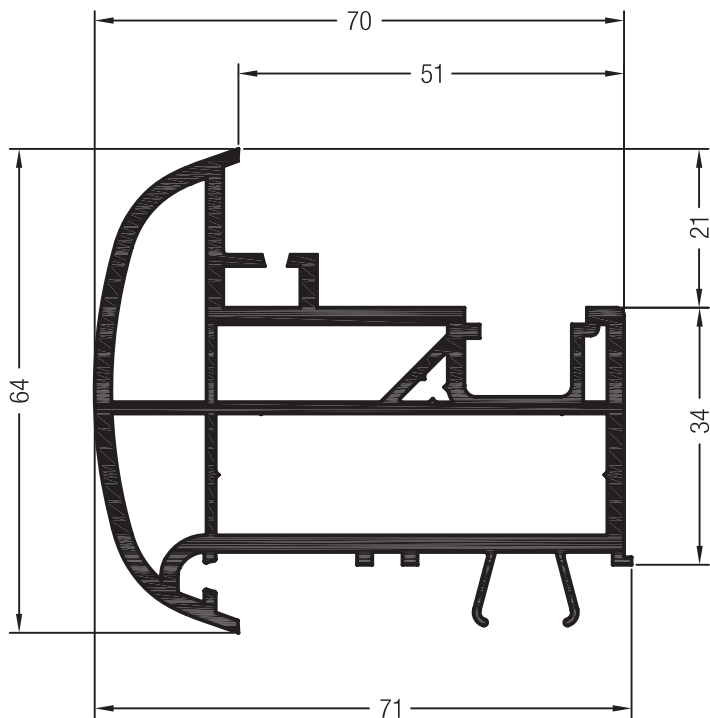

50 x 15

	222065
$\rightarrow$ $\leftarrow$	1,5
lx	4,9
ly	0,7
	6

Velká klapačka oblá konstrukční hloubky 70

550532

36

599532

24

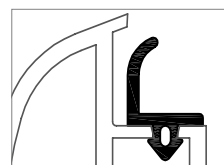

	864940
	865650
	835181

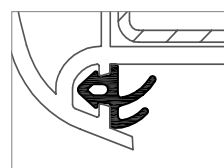

	864952
	865530
	835171

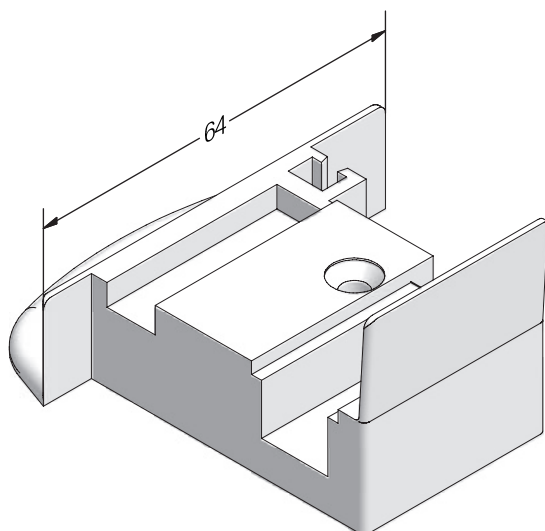

Koncovka pro velkou klapačku oblou konstrukční hloubky 70

RAU-ASA

228407

228417

50

# EURO-DESIGN 70

## TVARY PROFILŮ

### Příslušenství pro mechanické spojení

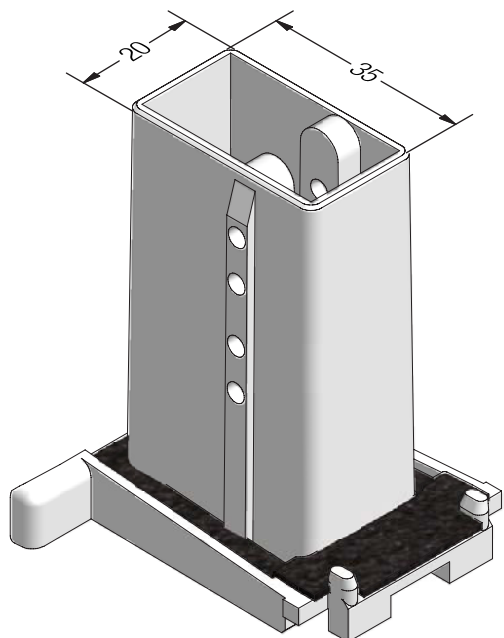

Mechanický spojovač sloupku 78 ED70

RAU-PA GF

229960   

 100

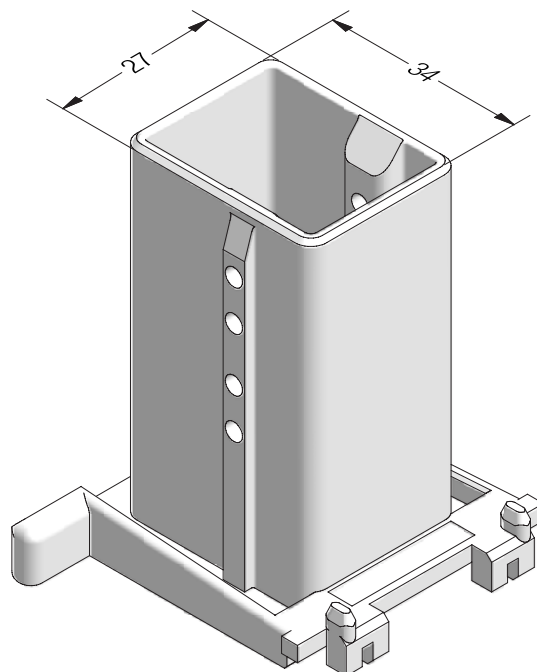

Mechanický spojovač č. 1 sloupku 86 konstrukční hloubky 70

RAU-PA GF

342487   

 60

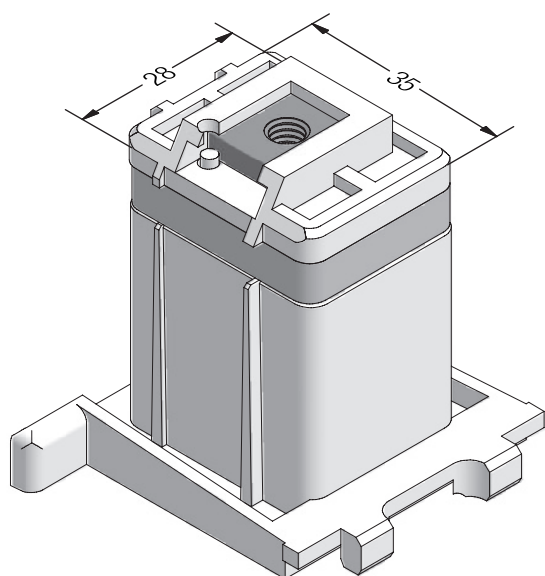

Mechanický spojovač č. 2 sloupku 86 konstrukční hloubky 70

RAU-PA GF

247446   

 90

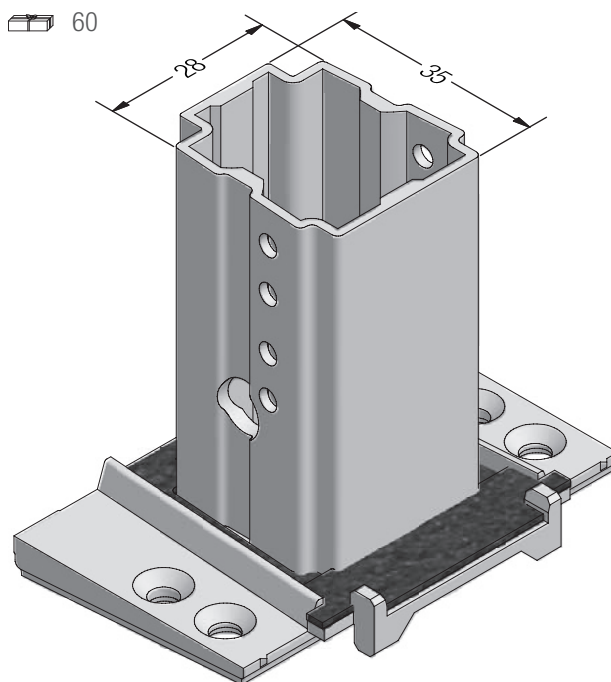

Mechanický spojovač ZDG sloupku 86 konstrukční hloubky 70

Zinkový odlitek

221664 

 50

# EURO-DESIGN 70

## TVARY PROFILŮ

### Příslušenství pro mechanické spojení

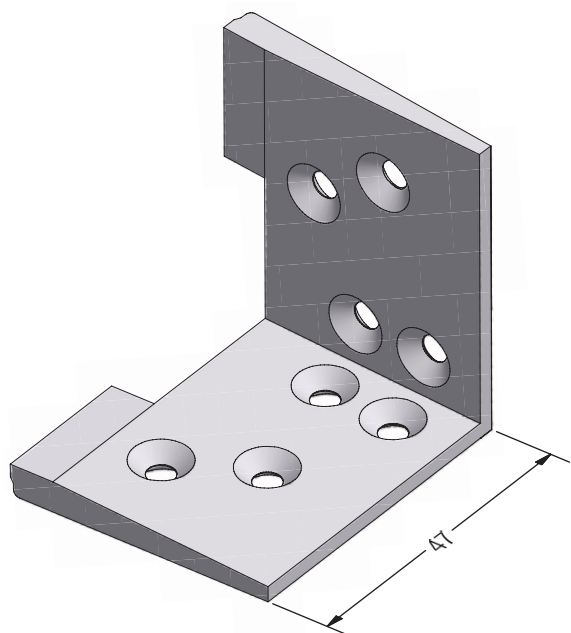

Úhelník konstrukční hloubky 70

Zinkový odlitek

**226253** 

 50

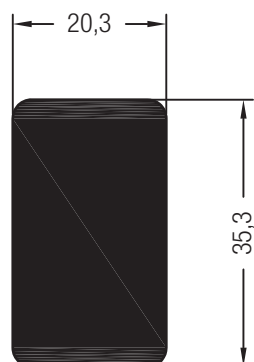

Mechanický spojovač univerzální  
pro sloupek 78

**247167** 

 2

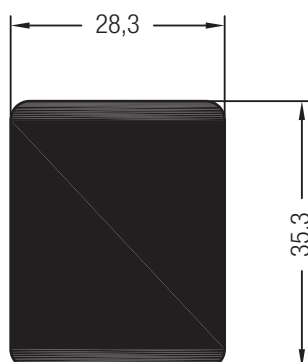

Mechanický spojovač univerzální  
pro sloupek 86

**260448** 

 2

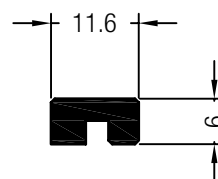

Upevňovací profil

**241957**  

 36

# EURO-DESIGN 70

## TVARY PROFILŮ

### Příslušenství pro mechanické spojení

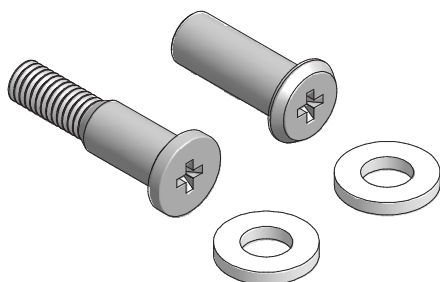

Sada šroubů pro 221664

Pozinkovaná ocel

**225274** 

 50

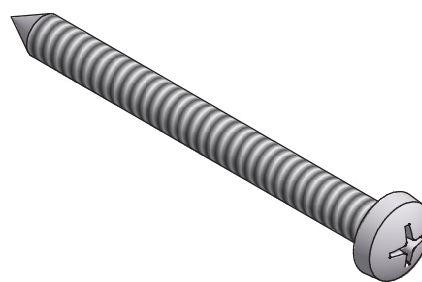

Šroub 6,3 x 70

Pozinkovaná ocel

**260633** 

 250

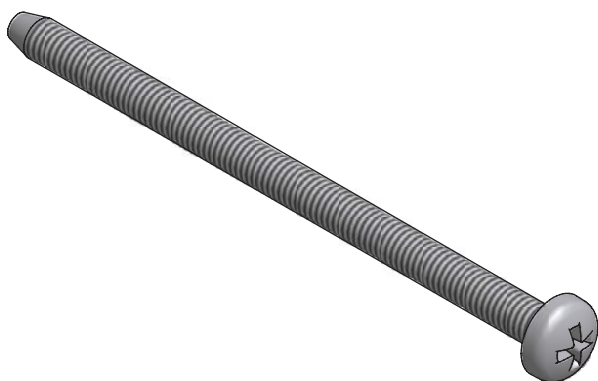

Šroub M6 x 100

Pozinkovaná ocel

**248448** 

 200

# EURO-DESIGN 70

## TVARY PROFILŮ

### Příslušenství pro dveřní napojení

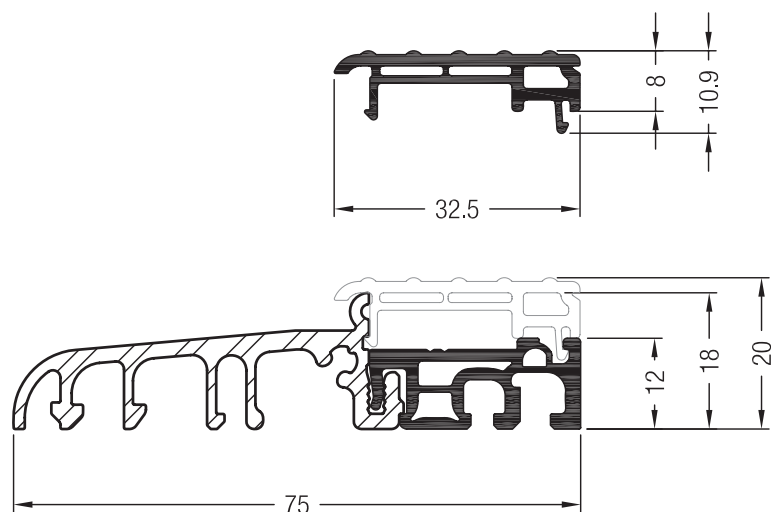

Sada prahu 20 konstrukční hloubky 70

**351656**  

 60

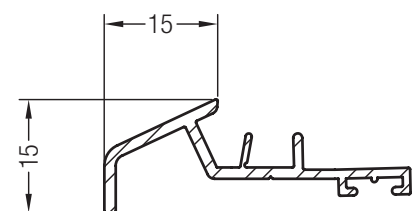

Okapnička 15 konstrukční hloubky 70

**352487** 

 6

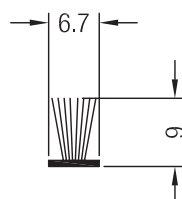

Kartáčové těsnění 6,7 x 9

**248095**

 50



# EURO-DESIGN 70

## TVARY PROFILŮ

### Příslušenství pro dveřní napojení

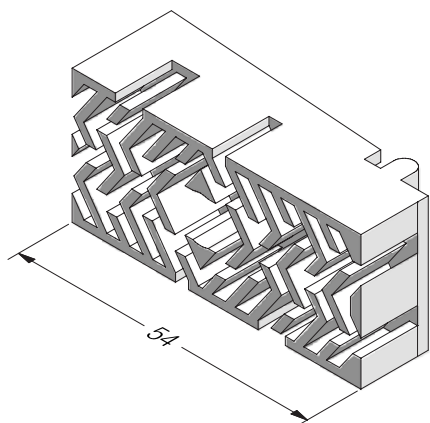

Těsnící díl pro univerzální dveřní práh  
konstrukční hloubky 70

**234776** 

 10

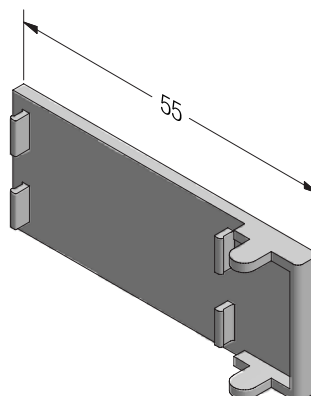

Krytka držáku prahu univerzálního dveřního prahu  
konstrukční hloubky 70

**223500** 

 100

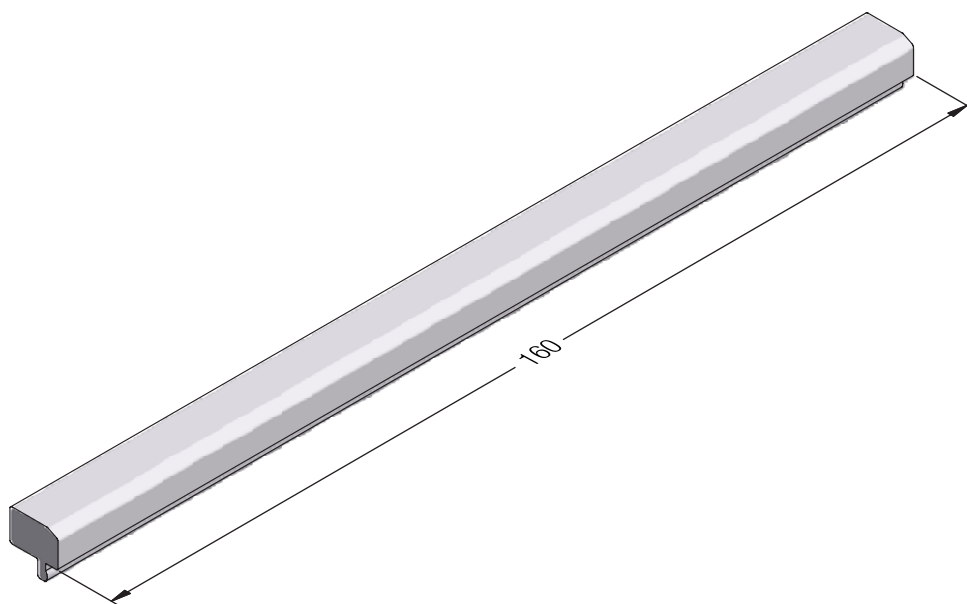

Adaptér dveřního prahu 20 konstrukční hloubky 70

**351657** 

 10

# EURO-DESIGN 70

## TVARY PROFILŮ

### Příslušenství pro dveřní napojení

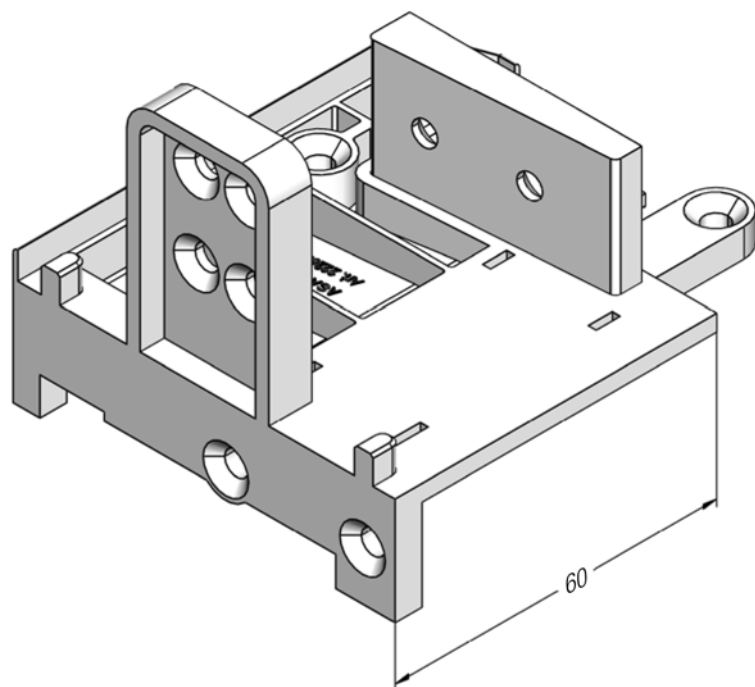

Držák prahu č.1 univerzálního dveřního prahu  
konstrukční hloubky 70 (pro rám 76-2 ED70)

**222690**   

**222695**   

 50

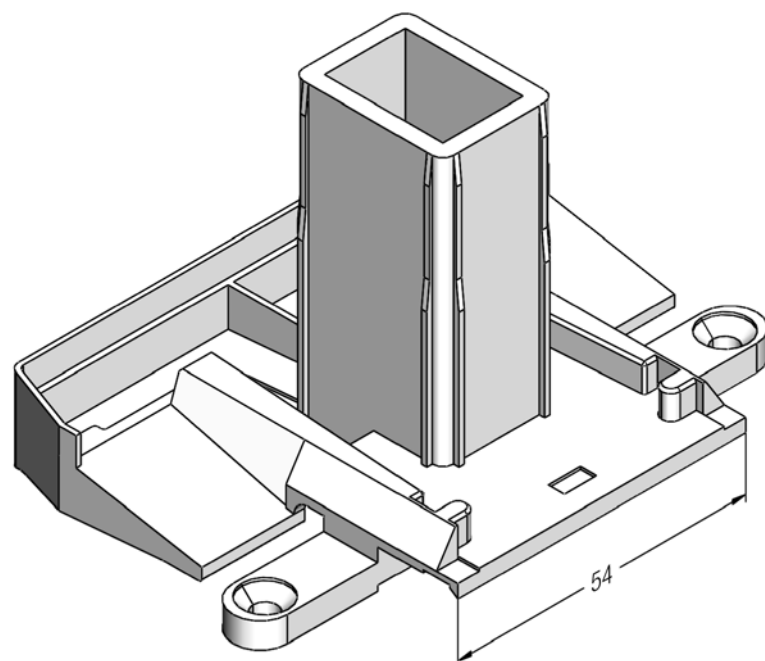

Držák prahu č.4 univerzálního dveřního prahu  
konstrukční hloubky 70 (pro sloupek 86 ED70 jen  
ve spojení s armováním 237091 nebo 249934)

**235056**  

 100

# EURO-DESIGN 70

## TVARY PROFILŮ

### Vrtací šablony

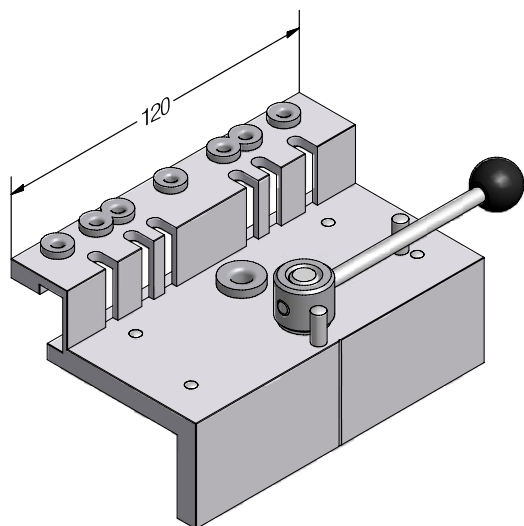

Vrtací šablona rámu konstrukční hloubky 70

**248346** 

 1

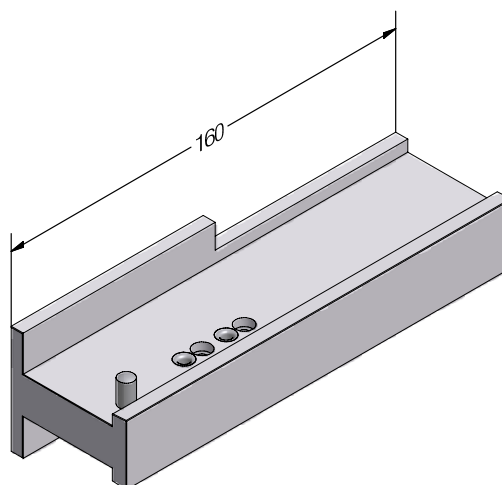

Vrtací šablona sloupku/poutce konstrukční hloubky 70

**241947** 

 1

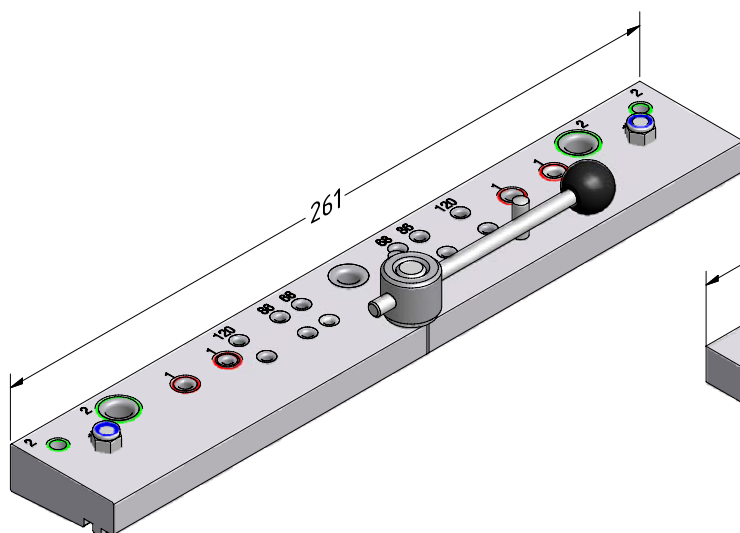

Vrtací šablona kovových spojovačů konstrukční hloubky 70

**222529** 

 1

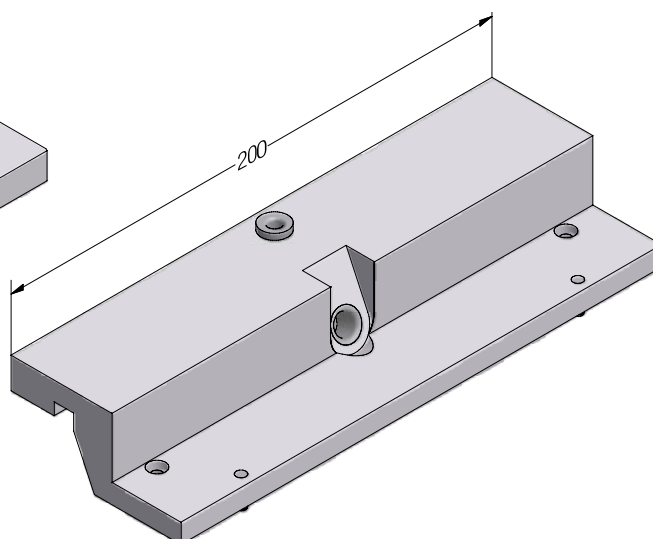

Vrtací šablona odvětrání předkomor

**248175** 

 1

# EURO-DESIGN 70

## TVARY PROFILŮ

Příslušenství pro rám pro panelové domy

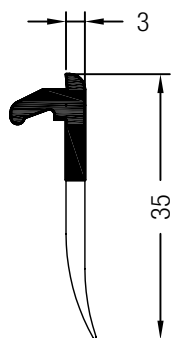

Ukončovací lišta č. 4  
**553370**    @  
 72

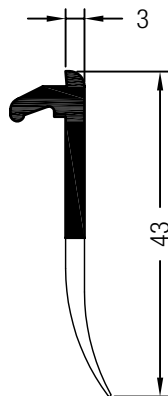

Ukončovací lišta č. 1  
**553200**    @  
 72

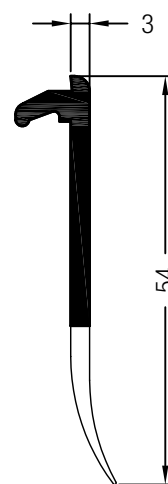

Ukončovací lišta č. 2  
**553190**    @  
 48

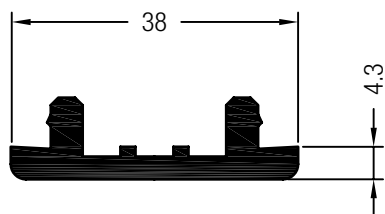

Spojovací profil  
**553210**   
 72

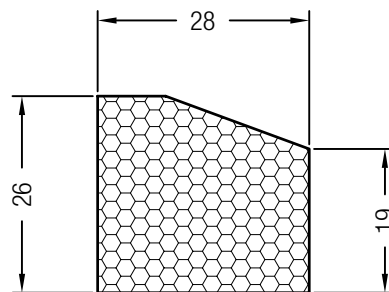

Izolační klín  
**299721-140**   
 25

# EURO-DESIGN 70

## TVARY PROFILŮ

### Armování

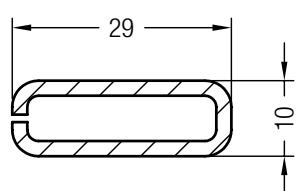
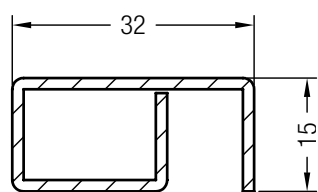
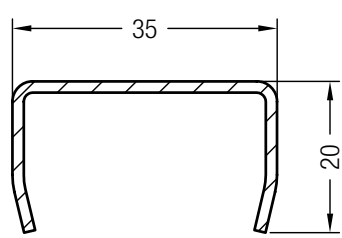
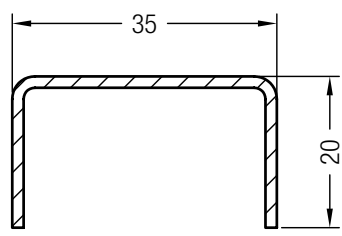
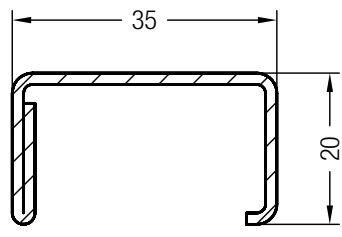
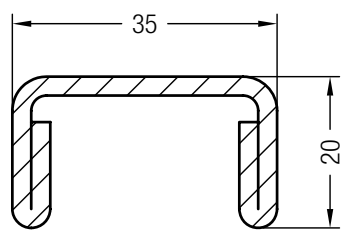
	Art.č.		lx	ly
	<b>241620</b>	2	1,1	0,18
	<b>283312</b>	1,5	1,5	0,41
	<b>351103</b>	1,5	2,0	0,42
	<b>245536</b>	1,5	2,0	0,42
	<b>261831</b>	1,5	2,5	0,56
	<b>261841</b>	2	3,1	0,69
	<b>245526</b>	2,5	4,2	0,9

# EURO-DESIGN 70

## TVARY PROFILŮ

### Armování

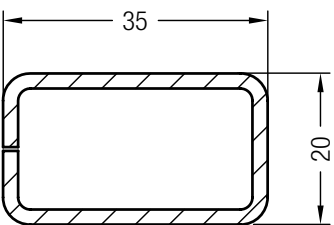
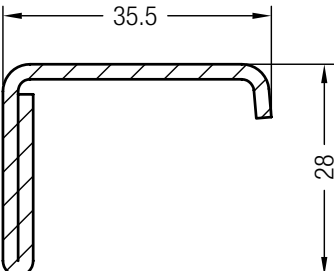
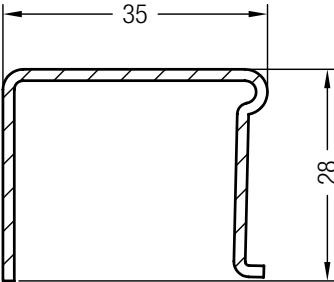
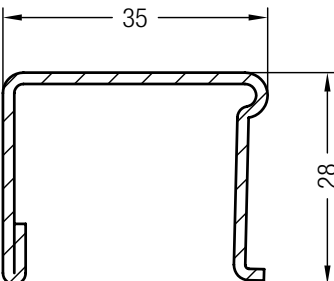
	Art.č.		lx	ly
	<b>239583</b>	1,5	2,3	0,98
	<b>261709@</b>	2	2,9	1,2
	<b>244546</b>	2	2,2	1,3
	<b>244506</b>	1,5	2,5	1,1
	<b>244516</b>	1,5	2,7	1,3
	<b>244526</b>	2	3,5	1,7

# EURO-DESIGN 70

## TVARY PROFILŮ

### Armování

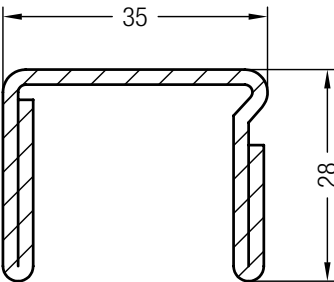
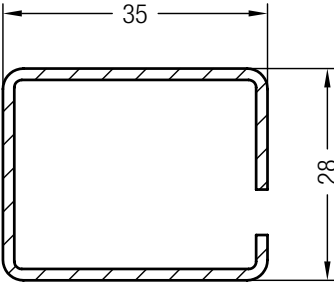
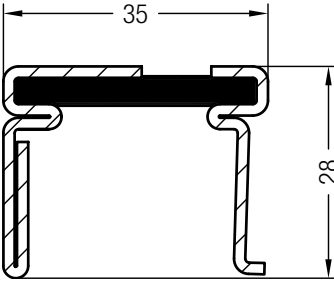
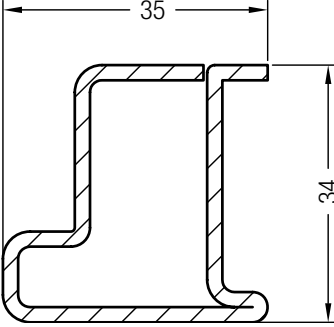
	Art.č.		lx	ly
	<b>244536</b>	2	5,0	2,0
	<b>237091</b>	1,5	2,8	2,1
	<b>249934</b>	2	3,4	2,6
	<b>233134</b>	1,5	-	-
	<b>227167</b>	2	2,7	3,9

# EURO-DESIGN 70

## TVARY PROFILŮ

### Armování

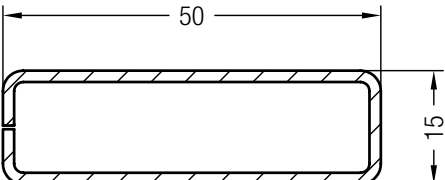
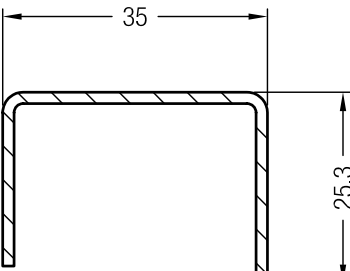
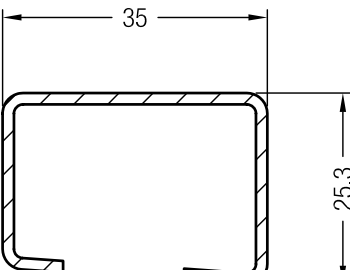
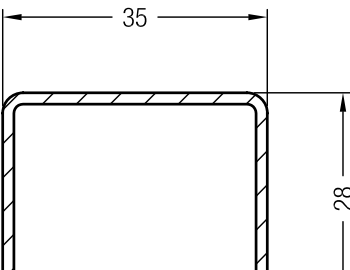
	Art.č.		lx	ly
	<b>222065</b>	1,5	4,9	0,7
	<b>355520@</b>	1,5	2,4	0,72
	<b>355470</b>	1,5	2,7	1,2
	<b>355480@</b>	1,5	2,7	1,1



# EURO-DESIGN 70

## TVARY PROFILŮ

### Seznam artiklů

Art.č.	Označení	Balení/ svazek v m	Ocelová paleta v m		Kartó/ sáček v kusech	Strana
			Balení	Fólie		
221590	Koncovka pro statickou klapačku BT 70 pravá				50	17
221600	Koncovka pro statickou klapačku BT 70 levá				50	17
221664	Mechanický spojovač ZDG sloupku 86 BT 70				50	19
222065	Armování 50 x 15	300				29
222529	Vrtací šablona pro kovové spojovače BT 70				1	25
222690	Držák prahu univerzálního dveřního prahu č. 1 BT 70 pr.				50	24
222695	Držák prahu univerzálního dveřního prahu č. 1 BT 70 le.				50	24
222787	Koncovka pro klapačku BT 70 pravá				50	16
222797	Koncovka pro klapačku BT 70 levá				50	16
223500	Krytka držáku prahu univerzálního dveřního prahu				100	23
225274	Sada šroubů pro 221664				50	21
226253	Úhelník BT 70				50	20
227167	Armování 35 x 34	300				29
228407	Koncovka pro velkou klapačku oblou BT 70 pravá				50	18
228417	Koncovka pro velkou klapačku oblou BT 70 levá				50	18
229960	Mechanický spojovač pro sloupek 78 ED70				100	19
233134	Armování 35 x 28	300				29
234776	Těsnící díl pro univerzální dveřní práh BT 70				10	23
235056	Držák prahu univerzálního dveřního prahu č. 4 BT 70				100	24
237091	Armování 35 x 28	300				29
239583	Armování 35 x 20	504				28
241620	Armování 29 x 10	240				27
241947	Vrtací šablona sloupku/příčky BT 70				1	25
241957	Upevňovací profil	36				20
244506	Armování 35 x 28	504				28
244516	Armování 35 x 28	504				28
244526	Armování 35 x 28	504				28
244536	Armování 35 x 28	300				29
244546	Armování 35,5 x 28	300				28
245526	Armování 35 x 20	300				27
245536	Armování 35 x 20	300				27
247167	Mechanický spojovač univerzální pro sloupek 78	2				20
247446	Mechanický spojovač č. 2 sloupku 86 BT 70				90	19
248095	Kartáčové těsnění 6,7 x 9				50	22
248175	Vrtací šablona odvětrání předkomor				1	25
248346	Vrtací šablona rámu BT 70				1	25
248448	Šroub M6 x 100				200	21
249934	Armování 35 x 28	300				29
260448	Mechanický spojovač univerzální pro sloupek 86	2				20
260633	Šroub 6,3 x 70				250	21
261709@	Armování 35 x 20	6				27

# EURO-DESIGN 70

## TVARY PROFILŮ

### Seznam artiklů

Art.č.	Označení	Balení/ svazek v m	Ocelová paleta v m		Kartó/ sáček v kusech	Strana
			Balení	Fólie		
261831	Armování 35 x 20	300				27
261841	Armování 35 x 20	300				27
283312	Armování 32 x 15	504				27
299721-140	Izolační klín	25		250		26
342487	Mechanický spojovač č. 1 sloupku 86 BT 70				60	19
351103	Armování 35 x 20	300				27
351656	Sada dveřního prahu 20 BT 70	60				22
351657	Adaptér dveřního prahu 20 BT 70				10	23
352487	Okapnička 15 BT 70	6				22
355470	Armování 35x25,3x1,5	300				30
355480	Armování 35x28x1,5	300				30
355520	Armování 35x25,3x1,5	300				30
550003	Rám 64 ED70	36	540	576		3
550051	Křídlo A60 ED70	36	324	462		14
550080	Klapačka BT 70	36	972	972		16
550131	Rám pro panelové domy - Rám 115-4K ED70	12	240			6
550333	Rám 64 ED70 s těsněním	36	540	528		3
550351	Křídlo A60 ED70 s těsněním	24	360	420		14
550413	Křídlo Z60 ED70	24	480	480		13
550433	Křídlo Z60 ED70 s těsněním	24	480	480		13
550460	Křídlo 60 oblé ED70	36	324	462		15
550463	Křídlo 60 oblé ED70 s těsněním	24	360	420		15
550490	Vyrovnávací profil 54 BT 70	24	480			11
550532	Velká klapačka oblá BT 70	36	612			18
550613	Sloupek 78 ED70	36	432	480		9
550633@	Sloupek 78 ED70 s těsněním	36	432	480		9
550713	Rám 68 ED70	36	432	528		4
550733	Rám 68 ED70 s těsněním	36	432	528		4
550761	Rám 76-2 ED70	36	468	480		5
550763	Rám 76-2 ED70 s těsněním	36	468	480		5
550770	Statická velká klapačka BT 70	36	540			17
550800	Rám 62 ED70			576		2
550810	Křídlo Z54 ED70			576		12
550813	Sloupek 86 ED70	36	432	480		10
550833	Sloupek 86 ED70 s těsněním	36	432	480		10
550913@	Základní rám 68 ED70		468			8
550990@	Rám pro rekonstrukce 60 ED70	24	432			7
550933@	Základní rám 68 ED70 s těsněním			480		8
550995@	Rám pro rekonstrukce 60 ED70 s těsněním	24	504	504		7
550999@	Rám pro rekonstrukce 37 ED70 s těsněním			504		7
553190	Ukončovací lišta č. 2	48	4800			26

# EURO-DESIGN 70

## TVARY PROFILŮ





























### Seznam artiklů

Art.č.	Označení	Balení/ svazek v m	Ocelová paleta v m		Kartó/ sáček v kusech	Strana
			Balení	Fólie		
553200	Ukončovací lišta č. 1	72	6192			26
553210	Spojovací profil	72	3456			26
553370	Ukončovací lišta č. 4	72	6048			26
599003	Rám 64 ED70 (kaširovaný)	36	540			3
599051	Křídlo A60 ED70 (kaširované)	36	324			14
599080	Klapačka BT 70 (kaširovaná)	36	972			16
599351	Křídlo Z60 ED70 s těsněním (kaširované)	36	324			14
599413	Křídlo Z60 ED70 (kaširované)	36	432			13
599433	Křídlo Z60 ED70 s těsněním (kaširované)	24	480			13
599461	Křídlo 60 oblé ED70 (kaširované)	36	324			15
599463	Křídlo 60 oblé ED70 s těsněním (kaširované)	24	360			15
599490@	Vyrovnávací profil 54 BT 70 (kaširovaný)	24	480			11
599532	Velká klapačka oblá BT 70 (kaširovaná)	24	672			18
599613	Sloupek 78 ED70 (kaširovaný)	36	432			9
599713	Rám 68 ED70 (kaširovaný)	36	432			4
599733	Rám 68 ED70 s těsněním (kaširovaný)	36	432			4
599761	Rám 76-2 ED70 (kaširovaný)	36	432			5
599763	Rám 76-2 ED70 s těsněním (kaširovaný)	36	432			5
599770	Statická velká klapačka BT 70 (kaširovaná)	24	576			17
599813	Sloupek 86 ED70 (kaširovaný)	36	432			10
599833	Sloupek 86 ED70 s těsněním (kaširovaný)	36	432			10
599913@	Základní rám 68 ED70 (kaširovaný)	36	468			8
599995@	Rám pro rekonstrukce 60 ED70 s těsněním (kaširovaný)	24	504			7
599933@	Základní rám 68 ED70 (kaširovaný)	24	480			8
599999@	Rám pro rekonstrukce 37 ED70 s těsněním (kaširovaný)	24	504			7

# EURO-DESIGN 70

## TVARY PROFILŮ

### Vysvětlivky značek

	Barva černá
	Barva šedá
	Barva bílá
	Barva krémově bílá
	Barva hnědá
	Barva karamelová
	Barva zelená
	Barva červená
	Barva stříbrná
	Barva libovolná
	Hliník přírodně eloxovaný
	Hliník surový
	Kaširované provedení
	Lakované provedení
	Balící jednotka (detaily viz. Seznam artiklů)
	Tloušťka stěny v mm
	Se svařovacím těsněním
	Ručně natahované těsnění
	Pravé provedení
	Levé provedení
@	Nestandard, dodací termín na dotaz
$I_x$	Moment setrvačnosti ve směru osy X v $\text{cm}^4$
$I_y$	Moment setrvačnosti ve směru osy Y v $\text{cm}^4$
	Přilepit lepidlem na PVC
	Zatěsnit silikonem
	Zatěsnit těsnící hmotou EPDM
	Přilepit lepidlem na EPDM
	Samořezný šroub s čičkovou hlavou ISO 7049
	Samořezný šroub se zápustnou hlavou ISO 7050
	Samořezný šroub do železa se zápustnou hlavou
	Obvod profilu v mm
	Vrtací šablona



---

Všechny rozměry, uvedené v tomto podkladu, jsou přibližné. Platí pro ně výlučně tolerance, definované v našich Dodacích a platebních podmínkách. Proto doporučujeme nejdříve prověřit, zda údaje popsané v tomto podkladu vyhovují Vašemu technickému řešení. Použití, užívání a zpracování našich produktů probíhá mimo dosah našich možností kontroly a z toho důvodu za ně plně zodpovídáte Vy. Naše záruka se tak vztahuje v každém případě na stálou kvalitu našich produktů podle naší

specifikace a v rozsahu určeném našimi obecnými Dodacími a platebními podmínkami, se kterými jste byli seznámeni. V rámci záruky ručíme za všechny škody pouze do výše hodnoty našeho zboží, které bylo prokazatelně námi dodáno a Vámi použito. Za škody, ke kterým došlo z důvodu použití jiných dílů, doplňků a materiálů, než jsou originální díly, doplňky a materiály, popsané v našich podkladech, neneseme REHAU žádnou odpovědnost ani záruku.