



**Engineering progress
Enhancing lives**

NEA SMART 2.0 Service Manual

Manual for Designer, Installer and Service
Partner



Manual

This service manual "NEA SMART 2.0" is valid from March 2021. With its publication, the previous service manual no. 954647 (October 2019) is no longer valid.

The actual Technical Information is available for download under www.rehau.com/TI.

This document is protected by copyright. The rights conferred therein are reserved, in particular those relating to the translation, reprinting, extraction of pictures, electronic transmissions, reproduction by photo-mechanical or similar means and storage on data processing equipment.

All dimensions and weights are approximate. Subject to errors and modifications.

01	Security	06
02	Introduction	07
03	System overview	08
04	Function	18
05	Component selection	38
06	Installation	49
07	System set up	50
08	Operating of NEA SMART 2.0 System	73
09	Parameter	96
10	Data	107
11	Scheme	119
12	Nomenclature	129

Content

01	Security	06		
02	Introduction	07		
03	System overview	08		
03.01	Range of Application	08		
03.02	Sytem overview	09		
03.03	Components of the system	10		
03.04	Functions and Features	15		
03.04.01	Room temperature control (surface heating/cooling)	15		
03.04.02	Room temperature control optimisation functions	15		
03.04.03	Hybrid technology (bus/wireless), pairing of room units	15		
03.04.04	Integrated WLAN/LAN, operation via browser or app	15		
03.04.05	Smart functions	15		
03.04.06	Flow temperature control	16		
03.04.07	Dehumidification	16		
03.04.08	Fan Coil	16		
03.04.09	Over the air update (OTA)	16		
03.05	System set-up	16		
03.05.01	General procedure	16		
03.05.02	Assignment of Room units/Room probes (pairing)	16		
03.05.03	Set up and operate using integrated web pages	16		
03.06	Operation, monitoring and maintenance on App	17		
03.07	System limits	17		
04	Function	18		
04.01	Operating modes	18		
04.01.01	Heating / Cooling (automatic mode)	18		
04.01.02	Only Heating / only Cooling	19		
04.01.03	Heating / cooling manual	19		
04.01.04	Energy levels	19		
04.01.05	Selection of energy levels	20		
04.01.06	Rules for overriding individual energy levels by global setting	20		
04.01.07	Temporary room temperature set point change (timed mode)	20		
04.01.08	Permanent room temperature set point change	20		
04.02	Heating and cooling systems	21		
04.02.01	Available systems	21		
04.02.02	Combination of systems	21		
04.02.03	Use of Fan Coils	21		
04.02.04	Supply of systems	21		
04.03	Heating mode	22		
04.03.01	Start and stop of heating mode	22		
04.03.02	Influence of pilot rooms	23		
04.03.03	Boost function	24		
04.04	Cooling mode	24		
04.04.01	Cooling criterion	24		
04.04.02	Flow temperature set point in cooling mode	25		
04.04.03	Dew point monitor	26		
04.04.04	Dehumidifiers	26		
04.04.05	Summer compensation	26		
04.05	Supply control of heat and cool media	27		
04.05.01	Manifold selection	27		
04.05.02	Pump control	27		
04.05.03	Mixed circuits	27		
04.05.04	Boiler and chiller control	27		
04.06	Room temperature control	28		
04.06.01	Adaption to used system	28		
04.06.02	Controller type: Proportional – Integral (PI)	28		
04.06.03	Valve control by PWM method	28		
04.06.04	Overview of individual room settings	29		
04.06.05	Timer programs	29		
04.06.06	Auto start function	30		
04.06.07	Pilot rooms	30		
04.06.08	Parameter "economy"	30		
04.06.09	User settings and operating	30		
04.06.10	Remote temperature probe for room units	31		
04.06.11	Rooms with various heating / cooling systems	31		
04.06.12	Geofencing	31		
04.07	Digital input and output signals	32		
04.07.01	Digital input signal	32		
04.07.02	Digital output signal	33		
04.08	System operating and monitoring	34		
04.08.01	Using the room units	34		
04.08.02	Integrated web pages	34		
04.08.03	Installer only web pages – Commissioning wizard for global system set-up	34		
04.08.04	Installer only web pages – Room setup and parametrization	35		
04.08.05	User Web pages	35		
04.08.06	NEA SMART 2.0 App	35		
04.08.07	Warnings and alarm functions	36		
04.09	System response in case of fault	36		
04.09.01	Communication problems	36		
04.09.02	Probe faults	36		
04.09.03	Control issues	36		
04.09.04	Other issues	37		
05	Component selection	38		
05.01	Starting Point	38		
05.02	Minimum and maximum configurations	38		
05.03	Selection Process	39		
05.03.01	Hydraulic Manifolds	39		
05.03.02	Mixed circuits	39		
05.03.03	Dehumidifiers	39		
05.03.04	Fan Coils	39		
05.03.05	Analog Inputs	39		
05.03.06	Digital Inputs	40		
05.03.07	Digital Outputs	42		
05.04	Internet Connection	43		
05.05	Wiring	43		
05.06	Application Examples	45		
05.06.01	Heating system with mix of wireless and wired Room units (up to eight rooms)	45		
05.06.02	Heating and Cooling system with mix of wireless and wired Room units and R-Module (up to twelve rooms)	46		
05.06.03	Heating and Cooling system with mix of wireless and wired Room units and slaves (up to twenty four rooms)	47		
05.06.04	Heating and Cooling system with mix of wireless and wired Room units and U-Module (for mixed circuit)	48		
06	Installation	49		
06.01	Leaflets	49		
07	System set up	50		
07.01	General remarks to set up procedure	50		
07.01.01	Preparation	50		
07.01.02	Different complexity of systems (class A, B, C)	50		

07.01.03	Flow chart of set up procedure	50	08.02.03	Installer area	81
07.02	Set system bus addresses	51	08.03	Operating by REHAU SMART 2.0 App	86
07.03	Switch on power supply	51	08.03.01	Installation of the App	86
07.03.01	Check POWER / FUSE LED's	52	08.03.02	Setting up the App	86
07.03.02	Check zone bus LED's	53	08.03.03	Getting to know the App	87
07.03.03	Check manifold actuators	53	08.03.04	First steps in the App	90
07.04	Pairing	53	08.03.05	Smart function Geofencing	92
07.04.01	General notes	53	08.03.06	Account Management	92
07.04.02	Start pairing procedure on Base	53	08.03.07	Useful tips	92
07.04.03	Pairing of NEA SMART 2.0 Room Units	54	08.04	FAQ's and troubleshooting	94
07.04.04	Pairing of NEA SMART 2.0 Room probes	55	08.04.01	Problems and potential causes	94
07.04.05	Pairing of NEA SMART 2.0 outdoor sensor	55	08.04.02	Error-codes on NEA SMART 2.0 Room Units	94
07.04.06	Further settings on NEA SMART 2.0 Room units	55	08.04.03	Change batteries of Room Units and Probes	95
07.05	Configuration - Wizard	57	09	Parameter	96
07.05.01	Introduction	57	09.01	Heating general	96
07.05.02	Preparation	57	09.01.01	Heating circuits	97
07.05.03	Example for configuration	58	09.01.02	Heating circuits, boost function	98
07.05.04	General settings	59	09.02	Heating circuits, boost function	99
07.05.05	Choose system type	59	09.02.01	Cooling circuits	100
07.05.06	Enter system components and functions	60	09.03	Mixing circuit control	101
07.05.07	System bus scan	61	09.04	Room temperature control	102
07.05.08	Define function of system bus components	61	09.05	Device control	103
07.05.09	Input / output assignment of U-Modules for mixed circuit	62	09.05.01	Heater control	103
07.05.10	Definition of mixed circuit operating	63	09.05.02	Chiller control	103
07.05.11	Links between mixed circuits and manifolds	63	09.06	Dehumidifier control	104
07.05.12	Input / output assignment of U-Modules for dehumidifiers	63	09.07	Pump control	105
07.05.13	Input / Output assignment of U-Modules for fan coils	64	09.08	Valve control	106
07.05.14	Input/output assignment of U-Modules for Fan coil/Dehumidifier	64	09.09	Eu.bac - Energy-optimized settings	106
07.05.15	Overview of Base units	65	10	Data	107
07.05.16	Definition of room operating modes	65	10.01	Electrical termination	107
07.05.17	Definition of Fan Coils at Room Zones (RZ)	66	10.02	Factory settings	107
07.05.18	Definition of outputs of the Base	67	10.02.01	Base	107
07.05.19	Definition of inputs of the Base	67	10.02.02	R-Module	108
07.05.20	Automatic mode and remote control of the operating mode	68	10.02.03	U-Module (Defined as Mixed circuit)	108
07.06	Installer main menu	68	10.02.04	U-Module (Defined for Dehumidifier)	109
07.06.01	Timer programs	69	10.02.05	U-Module (defined for Fan Coil)	110
07.06.02	Room set up	70	10.02.06	U-Module (defined for dehumidifiers and fan coil)	111
07.06.03	System data	71	10.03	Allocation of the clamps	112
07.06.04	Diagnosis / probe calibration	71	10.03.01	NEA SMART 2.0 Base 24 V	112
07.06.05	Settings (Parameters)	71	10.03.02	NEA SMART 2.0 Base 230 V	113
07.07	Reset functions	72	10.03.03	NEA SMART 2.0 R-Module 230 V	114
07.07.01	Delete pairing of all channels (RZs) on a base	72	10.03.04	NEA SMART 2.0 R-Module 24 V	115
07.07.02	Delete pairing of outside temperature probe	72	10.03.05	NEA SMART 2.0 U-Module 24 V	116
07.07.03	Reset Controller to initial state	72	10.03.06	NEA SMART 2.0 U-Module 24 V – Mixed Circuit	117
07.07.04	Reset Room Unit	72	10.03.07	NEA SMART 2.0 U-Module 24 V - Dehumidifier	118
07.07.05	Reset room probe	72	11	Scheme	119
07.07.06	Reset WIFI Key to default setting	72	11.01	Overview	119
08	Operating of NEA SMART 2.0 System	73	11.01.01	Simple Room Temperature Control	120
08.01	Operating by NEA SMART 2.0 Room units	74	11.01.02	Enlarged Room Temperature Control	121
08.01.01	Display information	74	11.01.03	Enlarged Room Temperature Control with chilled ceiling	122
08.01.02	Order of the displayed information	75	11.01.04	Simple Room Temperature Control with mixed circuit	123
08.01.03	Setting the Setpoint of room temperature	76	11.01.05	Simple Room Temperature Control with mixed circuit and two dehumidifiers	124
08.01.04	Operating status	76	11.01.06	Simple Room Temperature Control with mixed circuit	125
08.02	Operating by web pages	77	11.01.07	Room Temperature Control with chilled ceiling, mixed circuit and two dehumidifiers	126
08.02.01	Connect a device	77			
08.02.02	User area	77			

11.01.08	Simple Room Temperature Control with chilled ceiling, mixed circuit and dehumidifiers	127
11.01.09	Large Room Temperature Control	128

12	Nomenclature	129
12.01	NEA SMART 2.0 Room unit	129
12.02	NEA SMART 2.0 Room probe	129
12.03	NEA SMART 2.0 Room unit TBW	130
12.04	NEA SMART 2.0 Room unit TRW	131
12.05	NEA SMART 2.0 Room unit HBW	132
12.06	NEA SMART 2.0 Room unit HRW	133
12.07	NEA SMART 2.0 Room unit HBB	134
12.08	NEA SMART 2.0 Room unit HRB	135
12.09	NEA SMART 2.0 Room probe TBW	136
12.10	NEA SMART 2.0 Room probe HBW	137
12.11	NEA SMART 2.0 Room probe TRW	138
12.12	NEA SMART 2.0 Room probe HRW	139
12.13	NEA SMART 2.0 Base 24 V	140
12.14	NEA SMART 2.0 Base 230 V	141
12.15	NEA SMART 2.0 R-Module 24 V	142
12.16	NEA SMART 2.0 R-Module 230 V	143
12.17	NEA SMART 2.0 U-Module 24 V	144
12.18	NEA SMART 2.0 Transformer	145
12.19	NEA SMART 2.0 Remote sensor	146
12.20	NEA SMART 2.0 VL/RL sensor	148
12.21	NEA SMART 2.0 Outdoor sensor	150
12.22	NEA SMART 2.0 Antenna	151
12.23	Thermal actuator UNI 24 V	152
12.24	Thermal actuator UNI 230 V	153
12.25	Thermal actuator MINI 24 V	154
12.26	Thermal actuator MINI 230 V	155
12.27	Actuator BALANCE 24 V	156
12.28	Actuator BALANCE 230 V	157
12.29	Coupling relay 24 V / 230 V	158
12.30	Switching relay 24 V / 230 V	159
12.31	NEA SMART 2.0 KNX Gateway	160
12.32	NEA SMART 2.0 Power supply gateway	161
12.33	NEA SMART 2.0 Bus Cable (10 / 50 m bundle)	162

01 Security

Pictograms and logos

Safety instructions are marked with the listed symbols.



Danger to life due to high voltage.



Safety information



Legal information



Important information which must be observed



Configurable parameter

Safety warnings and operating instructions

- For your own safety and the safety of other people, please read through all safety instructions and operating instructions carefully and completely before commencing assembly.
- Keep the operating instructions safe and have them available
- If you have not understood the safety instructions or any individual installation instructions or find them unclear, please contact your REHAU sales office.
- Non-compliance with the safety information may lead to damage to property and personal injury.

Product conformity

This product fulfils the requirements of the following EC guidelines:

- Electromagnetic compatibility 2014/30/EU
- Low-voltage directive 2014/35/EU

The complete CE certificates can be downloaded from the website www.rehau.com/neasmart2.

Use in line with the specification

The NEA SMART 2.0 control system must be configured, installed and operated only as described in this technical information and in the other installation manuals for the system. Any other use is not in accordance with the specification and is therefore not permitted.

Observe all national and international routing, installation, accident prevention and safety regulations and the instructions in this technical information when installing piping systems and electrical components and equipment.

Areas of application which are not covered by this technical information (special applications) must be discussed with our application department.

Contact your REHAU sales office.



Prerequisites for personnel

- Our systems must only be installed by authorised and trained personnel.
 - Only trained and authorised personnel may work on electrical installations or pipework components.
-

General precautions

- Keep your workplace clean and free of obstructions.
- Ensure that your work space has adequate lighting.
- Keep children, pets and unauthorised persons away from tools and installation areas. This particularly applies to renovations in occupied areas.

02 Introduction

Range of application

NEA SMART 2.0 is a modern and effective control system with a variety of functions for underfloor heating and cooling systems.

Important features are:

- Clear and high quality design of the room units
- Fully and automatic control of the complete installation
- Standard with WLAN/LAN interface
- For operation via web browser or App
- Smart functions that ensure a high level of comfort and ensure effective operation
- Suitable for new installations and retrofitting

Functions and control of the system

What can the NEA SMART 2.0 system?

The basic function of the system is to heat the rooms comfortably and economically.

Depending on the installed system many other functions are possible:

- Room cooling via the combined heating/cooling surfaces
- Automatic or manual change between heating, neutral and cooling
- Control of the optimum temperature for the supply of heating/cooling surfaces („flow temperature control“)
- Dehumidification of the rooms

Via timing programs and functions of the App, the set points of the room temperature – for heating and cooling – can be switched between comfort temperature (Normal mode) and Eco temperature (Reduced mode).

How to operate the system?

- Directly via the NEA SMART 2.0 Room units (setting the required temperature, changing the operating mode) as well as either
- Locally via the browser of your smartphone, tablet or PC (only inside the house, use of the integrated web pages) or
- Via Cloud of the NEA SMART 2.0 App – wherever you are

The NEA SMART 2.0 App is not only easy and user-friendly to use, it also offers many features that make the system a really smart system.

What can you adjust or look at?

Depending on installed options of the system, there are a variety of ways to set room temperatures, on-site or on-the-go, adapt the system to the needs, view statistics, or get hints and informations.

The table 02-1 gives an overview of the different possibilities.

It should be noted that during operating via the app (cloud connection), it does not matter where you are, while the operation via the integrated web pages only works within your home.

What can I do?	Room unit	Web pages (local)	App (via cloud)
Read room temperature, read and adjust temperature set point	✓	✓	✓
Select "Timer Program", "Normal" or "Reduced" mode	✓	✓	✓
Set timer programs and assign them to the rooms		✓	✓
Assign room names		✓	✓
Define room temperature set points for timer programs		✓	✓
Select heating or cooling mode		✓	✓
Use holiday mode		✓	✓
Automatic reduction of energy consumption during absence (geofencing)			✓
Check room temperature statistics			✓
In case of dehumidifier control: Set activation limits		✓	✓
In case of fan foil control: Select comfort level		✓	✓
In case of fan foil control: Start or stop operation			✓
Reduce energy consumption automatically during absence			✓
Receive notifications about events and faults that have occurred			✓
Get information about optimizations of the system			✓
Receive maintenance instructions			✓

Tab. 02-1 Possible adjustments on different devices

03 System overview

03.01 Range of Application

The NEA SMART 2.0 control system is a modular solution for radiant heating and cooling systems which can be configured for multiple systems.

The clear, high-grade room unit design discreetly blends into living spaces and offices. Due to its modular design, the system is suitable for individual room temperature control, as well as complex solutions for up to 60 rooms, including flow temperature control and integration of dehumidifier units. The modular design of the system is achieved by incorporating additional NEA SMART 2.0 Bases, NEA SMART 2.0 R-Module and NEA SMART 2.0 U-Module.

The system can be conveniently operated using a smartphone, tablet or PC at home or when the user is away from home via a LAN/WLAN integrated into the central control units as standard.

Connecting the system to the cloud allows the user to enjoy optimisation, analysis and remote maintenance functions.



The room units are available as a wireless or wired option (based on bus technology). Hybrid technology in the central control unit allows both options to be connected to the base station with no need for additional components, ensuring both options can be mixed as required.

Since the wired technology used for the room units does not have any special requirements for the type and topology of the installed lines, the wired solution can normally also be installed as a retrofit alongside the wireless technology, which can always be used..

1 NEA SMART 2.0 Base

- Base for 8 rooms
- Hybrid technology: suitable for Bus- and Wireless Room units/Room probes
- WLAN/LAN as standard



2 Actuators UNI, MINI or BALANCE

- Normally closed
- Energy-efficient: low power consumption

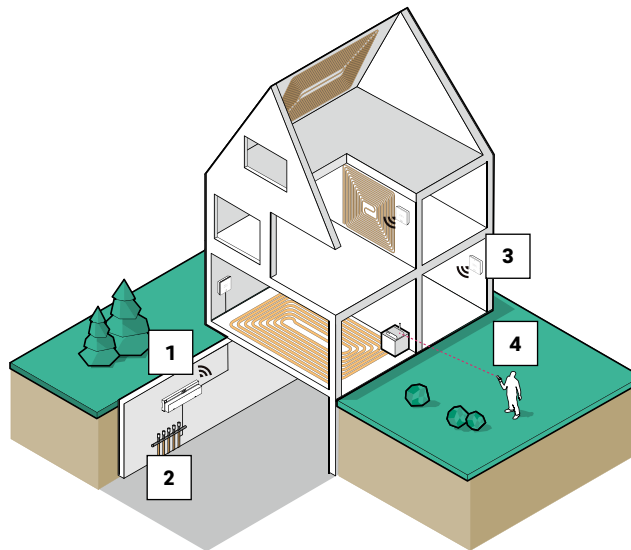

3 NEA SMART 2.0 Room unit/Room probe

- High quality design
- LED matrix display (only Room units)
- Bus and wireless variant



4 APP

- Configuration via smartphone/tablet
- Operation worldwide
- Remote maintenance and monitoring

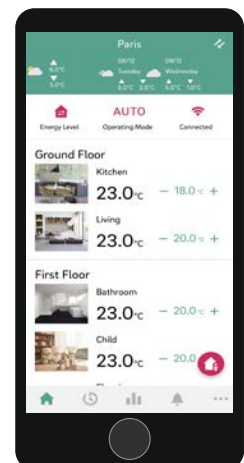

Fig. 03-1 System NEA SMART 2.0

03.02 System overview

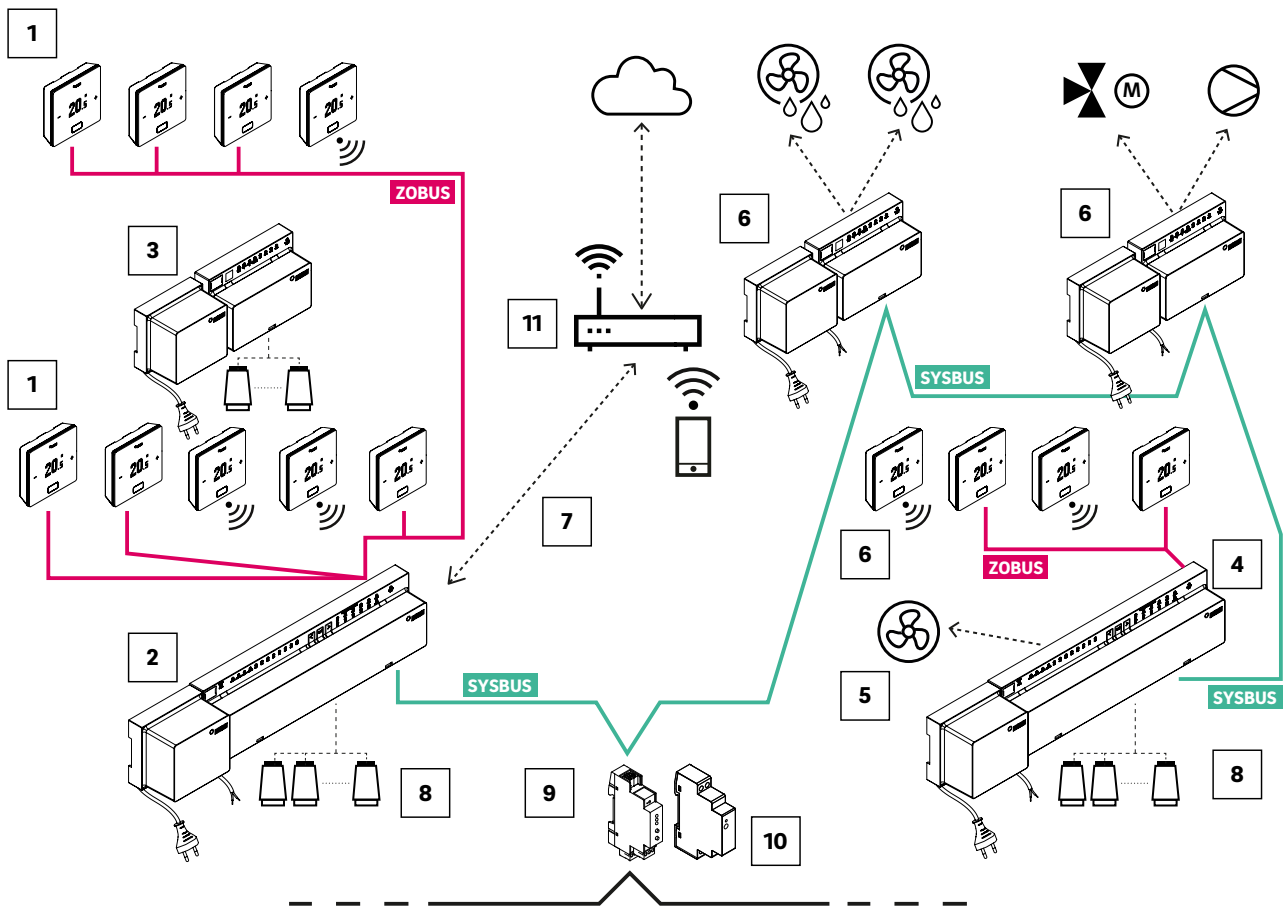

Fig. 03-2 System overview NEA SMART 2.0 for 24 V

SYSBUS System Bus (4-wire Bus, shielded cable)	4 NEA SMART 2.0 Base 24 V, central control unit (Slave) with transformer, for additional 8 rooms	9 NEA SMART 2.0 KNX Module
ZOBUS Zone Bus (2-wire Bus, cable typ and topology largely free, polarity does not have to be considered)	5 Fan Coil, controlled via NEA SMART Base 24 V	10 NEA SMART 2.0 Power supply gateway, generation of the auxiliary voltage for the SYSBUS (Modbus) of the REHAU NEA SMART 2.0 KNX gateway
1 NEA SMART 2.0 Room unit with display (Bus and Wireless)	6 NEA SMART 2.0 U-Module 24 V, extension module universal for mixed circuits, dehumidifier (with transformer to supply the mixing motor) or Fan Coil	11 Router
2 NEA SMART 2.0 Base 24 V, central control unit (Master) with transformer, for up to 8 rooms	7 WLAN/LAN interface to connect the system to the router and cloud	
3 NEA SMART 2.0 R-Module 24 V, extension module room for 4 more rooms (with transformer to supply the actuators)	8 Actuator 24 V to control the valves of the manifold	

Tab. 03-1 System overview NEA SMART 2.0 – Details

03.03 Components of the system

NEA SMART 2.0 Room unit



Fig. 03-3 NEA SMART 2.0 Room unit

Room units with LED matrix display, for mounting on a flush mounting box or directly onto the wall.

- Operation with a central button and capacitive plus/minus buttons
- Remote sensor connectable for floor temperature monitoring or room temperature control
- Illuminated frame to emit display and provide back-lighting for bus variant
- Flat housing

Variants:

- Bus or wireless technology
- With temperature or temperature/humidity sensor
- Housing color: white or black

NEA SMART 2.0 Room probe



Fig. 03-4 NEA SMART 2.0 Room probe

Room probe for mounting on a flush mounting box or directly onto the wall.

- Remote sensor connectable for floor temperature monitoring or room temperature control
- Flat housing

Variants:

- Bus or wireless technology
- With temperature or temperature/humidity sensor
- Housing color: white

NEA SMART 2.0 Base 24 V



Fig. 03-5 NEA SMART 2.0 Base 24 V

Central control unit for surface heating and cooling systems for installation in the manifold cabinet.

- Hybrid technology for connecting a maximum of 8 NEA SMART 2.0 Room units and Room probes in bus or wireless technology
- Extension of 4 rooms with NEA SMART 2.0 R-Module
- System extension with up to 4 additional NEA SMART 2.0 Bases possible. Up to 60 rooms can be controlled.
- Control of 12 REHAU actuators 24 V possible
- Control of up to 8 Fan Coils
- WLAN/LAN interface for integrating the system into the home network
- 4 relay outputs to actuate a pump, a hot or cold generator, a dehumidifier or other external units
- 4 digital inputs for connecting dew point sensors or for switching the operating mode
- Integrated status LEDs
- Screw less connection technology with clamped connectors
- Wall and DIN rail mounting
- Operating voltage via NEA SMART 2.0 Transformer

NEA SMART 2.0 Base 230 V

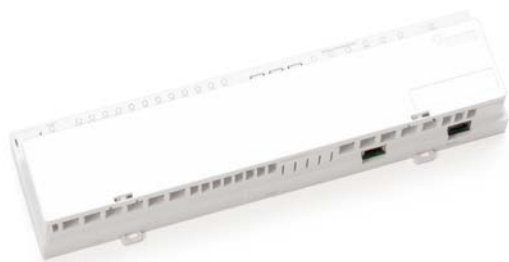

Fig. 03-6 NEA SMART 2.0 Base 230 V

Central control unit for surface heating and cooling systems for installation in the manifold cabinet.

- Hybrid technology for connecting a maximum of 8 NEA SMART 2.0 Room units and Room probes in bus or wireless technology
- Extension of 4 rooms with NEA SMART 2.0 R-Module
- System extension with up to 4 additional NEA SMART 2.0 Bases possible. Up to 60 rooms can be controlled.
- Control of 12 REHAU actuators 230 V possible
- Control of up to 8 Fan Coils
- WLAN/LAN interface for integrating the system in the home network
- 4 relay outputs to actuate a pump, a hot or cold generator, a dehumidifier or other external units
- 4 digital inputs for connecting dew point sensors or for switching the operating mode
- Integrated status LEDs
- Screw less connection technology with clamped connectors
- Wall and DIN rail mounting

NEA SMART 2.0 U-Module 24 V



Fig. 03-7 NEA SMART 2.0 U-Module 24 V

Universal extension module for NEA SMART 2.0 Base 24 V, configurable for:

- Control of a flow temperature or
- Control of up to 2 dehumidifiers or
- Control of up to 4 fan coils or
- Control of 2 dehumidifiers and 2 Fan coils
- Connection to NEA SMART 2.0 Base 24 V via 4-wire system bus
- Connection option for a wired external sensor
- 4 analogue inputs
- 4 relay outputs
- 4 digital inputs

- 1 analogue output (0 – 10 V DC)
- Status LEDs integrated
- Wall and DIN rail mounting

NEA SMART 2.0 R-Module 24 V



Fig. 03-8 NEA SMART 2.0 R-Module 24 V

Extension module for NEA SMART 2.0 Base 24 V to control 4 additional rooms.

- Connection to NEA SMART 2.0 Base 24 V via 2-wire Zone bus (ZOBUS), polarity reversal protected
- 8 REHAU actuators 24 V connectable
- 2 relay outputs to actuate a pump, a hot or cold generator, a dehumidifier or other external units
- 1 digital input for connecting dew point sensors or for switching the operating mode
- Integrated status LEDs
- Wall and DIN rail mounting

NEA SMART 2.0 R-Module 230 V



Fig. 03-9 NEA SMART 2.0 R-Module 230 V

Extension module for NEA SMART 2.0 Base 230 V to control 4 additional rooms.

- Connection to NEA SMART 2.0 Base 230 V via 2-wire Zone bus (ZOBUS), polarity reversal protected
- 8 REHAU actuators 230 V connectable
- 2 relay outputs to actuate a pump, a hot or cold generator, a dehumidifier or other external units
- 2 digital inputs for connecting dew point sensors or for switching the operating mode
- Integrated status LEDs
- Wall and DIN rail mounting

NEA SMART 2.0 Transformer

Fig. 03-10 NEA SMART 2.0 Transformer

24 V transformer to supply the NEA SMART 2.0 Base 24 V. For wall and DIN rail mounting.

NEA SMART 2.0 Outdoor sensor

Fig. 03-11 NEA SMART 2.0 Outdoor sensor

Wireless outdoor sensor, assignable to NEA SMART 2.0 Base. For wall mounting.

NEA SMART 2.0 Remote sensor

Fig. 03-12 NEA SMART 2.0 Remote sensor

Temperature sensor connectable to NEA SMART 2.0 Room unit.

Configurable for:

- Floor temperature monitoring in heating/cooling mode
- Measuring of the room temperature

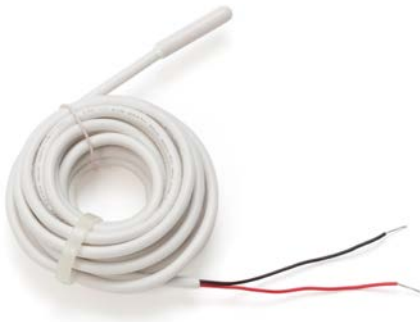
NEA SMART 2.0 VL/RL sensor

Fig. 03-13 NEA SMART 2.0 VL/RL sensor

Temperature sensor connectable to NEA SMART 2.0 R-Module to measure the supply and return temperature of a mixed circuit.

NEA SMART 2.0 Antenna

Fig. 03-14 NEA SMART 2.0 Antenna

Antenna for optional connection to NEA SMART 2.0 Base to increase the range of the radio signal to the NEA SMART 2.0 Room units.

- Mounting the antenna outside the manifold cabinet.

Thermal actuator UNI 230 V / 24 V

Fig. 03-15 Thermal actuator UNI 230 V / 24 V

Thermal actuator to activate the valves in a manifold.

- Normally closed
- Energy efficient, only 1 W power consumption
- Clear status display
- Can be installed in any position
- "First-open function" for operating in the construction phase (before installation of controllers)
- Can be adjusted for different types of valves and manifolds
- Protection rating IP54

Thermal actuator MINI 230 V / 24 V



Fig. 03-16 Thermal actuator MINI 230 V / 24V

Thermal actuator to activate the valves in a manifold.

- Compact design
- Ideal for mounting with valve distances < 45 mm
- easy plug mounting
- Energy efficient, only 1 W power consumption
- with valve adapter VA 80 S
- silent and maintenance-free

Actuator BALANCE 230 V / 24 V



Fig. 03-17 Actuator BALANCE 230 V / 24 V

Electric motor actuator for temperature-based hydraulic balancing. The temperature difference between flow and return temperature of the heating circuits is adjusted to a defined value, depending on the requirements. The working principle of the BALANCE actuator in radiant heating/cooling systems is comparable to a conventional hydraulic balancing

- Replaces existing thermoelectric or electric motor actuators
- Flow and return temperature sensors can be mounted easily, no danger to mix them up
- Fixes problems caused by uneven supply due to poor hydraulic balancing even in old installations with unknown circuit lengths
- Ensures regular floor temperatures
- Increased effectiveness in combination with NEA SMART 2.0 control system

NEA SMART 2.0 KNX gateway



Fig. 03-18 NEA SMART 2.0 KNX gateway

The NEA SMART 2.0 - KNX connection exchanges data (set points, actual values, operating modes and energy levels) between NEA SMART 2.0 and a centralised BMS System (KNX). The NEA SMART 2.0 KNX Gateway communicates with the NEA SMART 2.0 system via the SYSBUS, as a Modbus Slave. The assignment of KNX objects and Modbus registers can be configured via parameters in the ETS software (KNX license software). No additional software is required. The SYSBUS (Modbus) assignment required for the NEA SMART 2.0 control system can optionally imported via the provided example ETS project. The import of the SYSBUS (Modbus) assignments can be done in the office or on site.

The SYSBUS (Modbus) connection is galvanic isolated from the KNX Bus. The NEA SMART 2.0 Power Supply Gateway is used for the auxiliary voltage of the SYSBUS (Modbus). The KNX-Bus is supplied via the other KNX components on-site.

The device is to be DIN rail mounted in permanent internal (dry location) installations only.

- KNX TP/Modbus RTU interface specification
- 250 Channels per KNX Gateway
- Maximum 2 Gateway per NEA SMART 2.0 System; up to 500 Channels
- NOTE - Multiple NEA Smart 2.0 Systems per BMS (KNX) Installation are possible
- Configuration via the ETS Software (Licensed Software for KNX); no additional software is required
- Power Supply:
 - KNX nominal voltage 30 V DC
 - Auxiliary voltage on Modbus-side 12 ... 24 VDC
- In-line installation with 1 TE (18 mm)



For more than 30 rooms in the current functionality as described in the later data point list, an additional gateway should be used. The maximum amount of Gateways per Master/Slave installation is two.

Further information (e.g., the manual, datasheet and CE declaration of the KNX Gateway) can be downloaded from the product website of the KNX Modbus RTU Gateway 886 (www.weinzierl.de).



The Nea Smart 2.0 system does not support the communication with KNX Room units / probes. NEA SMART 2.0 room units / probes must be installed in rooms that are to be connected and controlled directly by the NEA SMART 2.0 system. The KNX Gateway (Modbus) is directly connected to the SYSBUS clamps of NEA SMART 2.0 Base unit – Specific clamp details are mentioned further in the document.

NEA SMART 2.0 Power supply gateway



Fig. 03-19 NEA SMART 2.0 Power supply gateway

The NEA SMART 2.0 Power Supply Gateway is a DIN rail mounted power supply with a direct current output (DC). This AC/DC-power supply is used to transform the auxiliary voltage for the SYSBUS (Modbus) of the NEA SMART 2.0 KNX Gateways. The potentiometer adjusts the output voltage. The blue LED indicates operation. The power supply unit is suitable for building automation controls in commercial and private premises. The device is to be DIN rail mounted in permanent internal (dry location) installations only.

Power Supply Specification:

- Switching power supply
- Output voltage: 12 V DC
- Output voltage Adjustment range: 10.8 V DC to 13.8 V DC
- Output power: 15 W
- Operating voltage: 85 V to 264 V AC
- Protection: Short circuit / Overload / Over voltage
- DIN rail TS TS-35/7.5 or TS-35/15 mountable
- 1 Potentiometer
- 1 LED (blue); Power-On



The gateways and associated power supplies must be properly installed in suitable housings such as switch boxes or control cabinets. The applicable regulations must be observed. Work on electrical systems or parts of cables may only be carried out by trained and authorized persons.

Coupling relay 24 V / 230 V



Fig. 03-20 Coupling relay 24 V / 230 V

Coupling relay with screw terminals for the transfer of 24 V AC or 230 V AC switching signals of a heat or cooling generator or a superordinate building management system to digital inputs of the NEA SMART 2.0 control system

- Mounting on 35 mm DIN rail
- Coil voltage 24 V AC or 230 V AC
- 2 2-pole switches 8 A
- Hard gold plated contacts, maximum switching current 8 A
- LED indicator

Switching relay 24 V / 230 V



Fig. 03-21 Switching relay 24 V / 230 V

Switching relay 24 V / 230 V with screw terminals for connection to Triac outputs or relay outputs of the NEA SMART 2.0 control system for controlling external devices

- Mounting on 35 mm DIN rail
- Coil voltage 24 V AC/DC or 230 V AC/DC
- 2 normally open contacts for 25 A / 250 V AC
- Mechanical and LED indicator
- Selector for AUTO – ON – OFF mode



The relays must be properly installed in suitable housings such as switch boxes or control cabinets. The applicable regulations must be observed. Work on electrical systems or parts of cables may only be carried out by trained and authorized persons.

NEA SMART 2.0 Bus cable (10 / 50 m bundle)

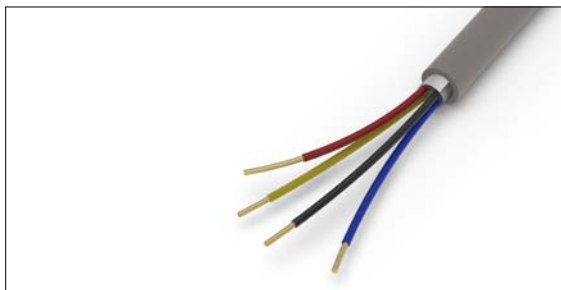

Fig. 03-22 NEA SMART 2.0 Bus cable (10 / 50 m bundle)

Shielded bus cable for System Bus and Zone Bus with 2 twisted pairs of wires

- Indoor installation cable, type J-Y(ST)Y 2 x 2 x 0.8 mm
- Solid bare copper conductor, PVC insulation
- static screen made of aluminum-laminated plastic film with copper drain wire
- Loop resistance max. 73.2 ohms/km
- Flame retardant according to IEC 60332-1-2

03.04 Functions and Features



The software of the NEA SMART 2.0 system is continuously being developed and improved. An update via an internet connection is required to take advantage of all the new and improved functions. By activating automatic updates (OTA), the system can always be kept up to date.

03.04.01 Room temperature control (surface heating/cooling)

Room temperatures are controlled by the valves in the manifold being opened at specified times, respective of the temperature recorded by the room units and the target temperature (pulsewidth modulation process – PWM).

A suitable set of parameters is selected for the chosen heating/cooling system, such as underfloor heating, ceiling heating or cooling systems.

It is possible to use different heating/cooling systems in one room at the same time without using auxiliary components, such as relay circuits or gate valves upstream of the manifolds.

03.04.02 Room temperature control optimisation functions



The NEA SMART 2.0 control system permanently analyses the temperature sequences in individual rooms and then optimises the control mode. Such optimisation provides maximum comfort while ensuring ideal energy efficiency:

- Compensation can aid comfort controls
- Detection of temperature drop in heating mode, e.g. due to open window
- Extremely precise compliance with the target values thanks to automatic adaptation of control parameters
- Auto boost function to ensure prompt return from reduced mode

03.04.03 Hybrid technology (bus/wireless), pairing of room units

The NEA SMART 2.0 Base offers the option of communicating with wired (bus technology) room units and wireless room units as standard. Room units can be easily and reliably registered on the individual base channels (pairing). The process is identical for both technologies.

03.04.04 Integrated WLAN/LAN, operation via browser or app

The NEA SMART 2.0 Base has WLAN/LAN as well as a web server standard „on board“. Systems used purely to control temperature (with a base) can be set up and operated using a standard web browser.

There is a user app available to end users featuring a series of easy-to-use functions to operate the system inside the house and while away from home. This app also offers analysis and maintenance information in a separate section for installer.

03.04.05 Smart functions

A series of smart functions are provided by the algorithms in the room units and bases and the option to evaluate temperature sequences and control mode in the cloud:

- Adjusting room temperatures using Amazon Alexa
- Automatic detection of the users' presence or absence with geofencing
- Detection of temperature drop in heating mode, e.g. due to open window
- Energy-saving mode is triggered when users are absent temporarily or for a longer period
- Room temperature analysis, automatic triggering of measures to improve control mode
- Information on improving energy efficiency

These smart functions are extended and improved on an ongoing basis.

03.04.06 Flow temperature control

The control of the flow temperature of the heating and cooling surfaces can be done via each NEA SMART 2.0 U-Module. Up to three mixed circuits may be installed in a single system. The flow temperature control is parametrised using pre-defined parameter sets, which are automatically selected based on the defined system, such as an underfloor heating or ceiling cooling system.

The flow temperatures are managed according to need. In addition to the characteristic values of outside temperature, energy requirements are also a factor in flow temperature management and are determined by the operating mode – normal, reduced or absence mode.

The room air humidity levels detected by the room units and the dew point calculated based on these levels play a decisive role in cooling applications.

03.04.07 Dehumidification

Dehumidifier units can be assigned to the individual areas in the installation, where each area can contain several rooms. The NEA SMART 2.0 components activate these units when relative humidity or dew point thresholds are reached.

Up to 9 dehumidifiers can be integrated into the system.

03.04.08 Fan Coil

To each room 1 fan coil can be assigned, that supports the installed system in case that the heating or cooling capacity is not sufficient.

03.04.09 Over the air update (OTA)

Systems which are connected to the cloud via the Internet receive the latest version of the on demand or automatically without requiring intervention from the user.

03.05 System set-up

The system is conveniently put into operation using a smartphone, tablet or PC. To do so, a direct wireless LAN (access point mode) connection is established between the NEA SMART 2.0 Base and the device used to set up operation.



No router or connection to the internet is needed.

03.05.01 General procedure

The system set-up is generally divided into the following steps:

1. Installing the components, establishing all connections, testing
2. Assignment of room units to the base or base unit channels (pairing)
3. Setting system-specific values: target values, time programs, parameters

03.05.02 Assignment of Room units/Room probes (pairing)

The Room units/Room probes are assigned to one or more channels of the Base or R-Module. Several channels may be required, because a channel's connection potential for actuators is exhausted or different systems, such as underfloor heating or ceiling cooling, are present in a room.

Successful pairing is signalled on the Room units/Room probes and the base.

03.05.03 Set up and operate using integrated web pages

In systems comprising a NEA SMART 2.0 Base and, where required, a R-Module (usual application for room temperature control only), the system can be adapted to the system conditions and user preferences. The system can be operated using a web browser on a smartphone, tablet or laptop.



However, this option is only available locally when the browser-capable unit is connected directly to the base.

In complex systems the following steps are performed:

- Input of building-specific data, such as the number of valves or mixed circuits
- Determination of the system's hydraulic structure (connection to the valves in the mixed circuit)
- Detection of all R-Modules connected to the Bases (zone bus)
- Detection of all Bases (slave units) and U-Modules connected to the system bus
- Displays for all Room units assigned to the Base control channels
- Assignment of the Base control channels to the heating/cooling systems in the rooms
- Assignment of dehumidifiers to rooms and definition of electric connections
- Assignment of 2nd heat exchanger
- Testing of all connected devices
- Issuing or adjustment of room names, target values, time programmes
- Parametrisation adjustment



All installation data are stored on the Base and after Internet connection into the cloud.

03.06 Operation, monitoring and maintenance on App

The app can only be used if the control system is connected to the Internet via the router and is registered in the cloud. App communication takes place with the cloud only. It therefore does not matter whether you use it inside or outside the building.

The app is the convenient tool for:

- Specification of room temperature setpoints
- Create and modify timing programs
- Activate short or long (holiday) absence periods
- Analysis of room temperatures

The installer or the contracted maintenance firm can use the app's expert section to:

- Check and change all settings
- Received system messages for maintenance requirements
- Analyze the behavior of the system
- Trigger the software update using OTA

The maintenance and repair options make things easier, especially for larger systems or systems which are further away.

The app can be downloaded in its latest version from the App store (iOS) or Google Playstore (Android).

03.07 System limits

The maximum configuration of a NEA SMART 2.0 system consists of:

- 1 x NEA SMART 2.0 Base (master)
- 4 x NEA SMART 2.0 Base (slave)
- 5 x NEA SMART 2.0 R-Module (extension modules room, per base one R-Module possible)
- 9 x NEA SMART 2.0 U-Module (extension modules universal)

In this expansion, the system includes a maximum of:

- 60 rooms
- 3 mixed circles
- 9 dehumidifiers (5 dehumidifiers on the base units or the R modules, 4 dehumidifiers on 2 U-modules)
- up to 60 fan coils (with exclusive use of fan coils)

A maximum of 5 U-Modules can be used also with a single base.



The relay outputs of the NEA SMART 2.0 components are pre-assigned specific functions to some extent. This pre-assignment can be changed when configuring the system.

This allows dehumidifiers or fan coils to be activated via the NEA SMART 2.0 Base or the NEA SMART 2.0 R-Modules as well as the NEA SMART 2.0 U-Module.

04 Function

In the following chapters you will find the description of all general and optional function of the system. The range of these functionalities is determined by the installed components and the system settings selected during commissioning or at a later stage.

The behaviour of the system is determined by the parameter settings.

All parameters can be modified by the installer or maintenance company, a subset of the parameters also by the user of the system.



At the end of each chapter there is an information block with the icon



which describes the path for web page or NEA SMART 2.0 App, starting from the main menu to the sub-menu containing the relevant parameters for the specific function:

Examples:

Web page:

Home → Installer → Settings → Heating / Cooling

App:

Settings → Heating / Cooling

All parameters have a default setting (factory setting), and may be changed only in a certain range.

A complete list of parameters you can find in chapter "9 PARAMETER".

04.01 Operating modes

Introduction

The term „operating mode“ describes a combination of settings, which are made via the NEA SMART 2.0 app or website. The first setting determines the general operation of the system:

- Heating or
- Cooling or
- automatic activation of heating/cooling

The second setting determines which energy level is selected and how it is selected:

- permanently NORMAL or
- REDUCED or
- controlled by timer program
- STANDBY, Holiday or PARTY mode

04.01.01 Heating / Cooling (automatic mode)

This mode is only possible in installations, where the system is capable to control the complete installation and has information about outside temperature (outside probe connected or weather information from internet service). During the setup sequence the installer may enable this option.

In this mode, the system changes automatically between the general operating mode heating, cooling and inactive.

Activation of HEATING mode depends on

- heating limit applied on filtered outside temperature
- hysteresis for heating limit
- heating period definition
- room temperature in pilot rooms
- time since last active cooling mode

Activation of COOLING mode depends on

- cooling criterion, calculated out of: filtered outside temperature, actual outside temperature, temperature conditions in pilot rooms
- cooling period definition
- time since last active heating mode

Both modes are subject to a minimum running time.

Activation of both modes is also influenced by

- the general energy level of the installation.
- external signals HEATING or COOLING coming from a superordinated system like a central heating/cooling source (e.g. a heat pump), a BMS or from a simple switch which allows or blocks heating or cooling mode.

See also table 04-1 for activation of operating modes.



Relevant parameters:

Web page:

Home → Installer → Settings → Heating / Cooling Settings

App:

Settings → Heating / Cooling

04.01.02 Only Heating / only Cooling

These operating modes follow the same rules as in HEATING / COOLING (automatic mode). The selected mode is activated as soon as the conditions are fulfilled.



Relevant parameters:

Web page:

Home → Installer → Settings → Heating / Cooling Settings

App:

Settings → Heating / Cooling

04.01.03 Heating / cooling manual

Selection of these modes overrides the above listed "soft" conditions (but not digital signals HEATING or COOLING coming from external) and the selected mode starts immediately.

These modes allow the user to start heating or cooling whenever it is possible in terms of available supply from boiler or chiller.

This mode can be used for testing during servicing and installation.

04.01.04 Energy levels

The energy level defines not only the temperature set points in the operating modes HEATING and COOLING, but also the operation of dehumidifiers and fan coils.

An energy level may be activated manually, by timing program or by the geofencing function of the App. An energy level is valid for the complete installation, a selection of rooms or a specific room.



The system optimizes the transitions between NORMAL and REDUCED mode to ensure comfortable conditions and to reduce energy consumption.

Please note also:

The installed heating or cooling systems have physical limits, which have to be considered, when set points and timer programs are defined.

- During summer, e.g., it is often not possible to reach a room temperature of e.g. 21 °C in cooling mode by means of an underfloor cooling system only
- It makes no sense to define short time spans per energy level trying to raise/or lower the temperature by 3 degrees for an hour and then to reverse it again because the underfloor system cannot respond that quickly

There are 4 different energy levels:

NORMAL

Energy level NORMAL should be active when the room is occupied.

- Default temperature set points:
Heating: 21 °C
Cooling: 24 °C

REDUCED

Energy level REDUCED should be active when the room is not occupied.

- Default temperature set points:
Heating: 19 °C
Cooling: 26 °C

PARTY mode

PARTY mode switches the energy level in the selected rooms to NORMAL for a default period of 4 hours.

When selected via the App, the activation period can be freely chosen (2 hours, 4 hours or endlessly until manual deactivation).

HOLIDAY / ABSENCE

Energy level HOLIDAY / ABSENCE is activated for time spans, which are longer than 1 up to 3 days, (depending on insulation standard of the building).

- Default temperature set points:
Heating: 15 °C
Cooling: not active



The temperature set points for NORMAL, REDUCED mode (heating/cooling) and HOLIDAY mode (only heating) can be set on the room configuration pages of the App or on the web pages.

STANDBY

The energy level STANDBY is used for rooms, which are not used for an extended period of time.

- Default temperature set points:
Heating: 5 °C (freeze protection)
Cooling: not active



The ranking of energy levels in terms of comfort and energy usage is (from high to low):

NORMAL → REDUCED → HOLIDAY → STANDBY

04.01.05 Selection of energy levels

The above listed energy levels or the way how they are activated (manual override or by timer program) can be selected using the App or the web pages for all rooms (global) or for each room individually.

When the global mode is selected using the web page, it is applied to all rooms. When the App is used, it is possible to exclude a set of rooms.

On each room unit with a display it is also possible to choose one of the energy levels for this room only.

Permanent selection

When an energy level is chosen, it is valid until it is changed.

Selection by timer program

The 5 weekly timing programs define the time spans for NORMAL and REDUCED.

The used weekly timer program can be selected for each room individually.

Automatic selection by geofencing

When this option is enabled, the system calculates the earliest expected return time of the user. Room temperatures are kept on a level, that the desired temperature level can be reached at return time.

Geofencing does not activate rooms which are set permanently to one of the energy levels.

04.01.06 Rules for overriding individual energy levels by global setting

When the user selects a global energy level on the web page, this energy level is applied to all rooms. If for one single room an individual energy level shall be activated, this can be done on the web page of this room or on the room unit.

When the App is used, the application proposes a list of rooms, for the global settings based on the rules listed below:

- General rules (using the NEA SMART 2.0 App):
- Rooms which are running in timed mode are proposed to follow the global command
- Rooms which are set to permanent energy level normal, reduced or standby are not proposed to follow the global command
- Global command STANDBY proposes all rooms to follow
- Global command Party and holiday proposes all rooms which have been selected the last time

Example 1:

The user selected for his hobby room the energy level REDUCED. A room, which is only used from time to time for guests, is set to "holiday/absence". All other rooms are running in timed mode, the NORMAL level for these rooms is on working days from 6 h AM until 8 h AM and from 17 h PM to 23 h PM.

One working day, the user stays at home and he switches his installation to global mode NORMAL.

Reaction of the App:

The App proposes all rooms except hobby room and the room for guests to follow the global command NORMAL.

Example 2:

Some of the rooms in a house are used permanently or should by any reasons not be set to lower energy level.

The user is off for several days and activates the holiday function. The first time he must select the rooms where this function should be applied. The next time he can just confirm the last selection of rooms.

04.01.07 Temporary room temperature set point change (timed mode)

Room temperature set points of rooms, which are running in timed mode, can be changed on the room unit, on web page or by the App. This new set point is valid until the next switching point of the timing program occurs.

04.01.08 Permanent room temperature set point change

When a room is in NORMAL or REDUCED, the room temperature set point modification overrides the previous set point. By this method, it is possible to (re)define the setpoints of room temperatures without using the room configuration pages on the App or on the web pages.

Procedure for room unit:

- Select energy level (normal or reduced mode)
- Modify set point
- Go to desired mode (timed, normal, reduced)
- New set point is stored and will be used from now on for this energy level.

04.02 Heating and cooling systems

04.02.01 Available systems

The following systems may be chosen during configuration sequence:

- Underfloor
- Wall
- Ceiling
- Fan coils

Each system may be used for

- heating only
- heating and cooling
- cooling only



Room temperature control for BKT systems (TABS) is not possible. The high thermal mass of a BKT system does not allow to compensate effects of varying internal loads or fast changes of outside conditions.

04.02.02 Combination of systems

It is possible to combine all types of systems in all modes of operation in each room.

Example:

Room 1: Underfloor heating
Ceiling cooling
Fan Coil

Room 2: Underfloor heating / cooling

Room 3: Underfloor heating
Ceiling heating

Room 4: Underfloor heating / cooling
Ceiling cooling

Note:

For each system in each room at least 1 channel (Room Zone, RZ) of the NEA SMART 2.0 Base is needed. The fan coil can be controlled via a free relay or via another channel.

In the example above at least 7 channels are necessary.



A combination of different systems (heating / cooling) in one room does not require additional measures like zone valves or external switch boxes to enable or disable valve actuators.

All logical connections are done by the controller based on the definition of manifolds and connected systems during commissioning.

04.02.03 Use of Fan Coils

To each room 1 fan coil can be assigned, but a fan coil cannot be assigned to multiple rooms. Fan coils can be defined for heating and cooling mode. A fan coil is started when the actual room temperature deviates from the set point by a certain amount, depending on which of the levels „Comfort“, „Normal“ or „ECO“ have been specified for the respective fan coil.



In rooms operated with the autostart function, the fan coil is not started prematurely in order to take advantage of the possibilities of the other systems used.

04.02.04 Supply of systems

The NEA SMART 2.0 System can control up to 3 mixed circuits in heating and cooling mode, which can be selected for the available systems

- Underfloor
- Wall and
- Ceiling

For each type of application there is a set of parameters predefined which is automatically loaded when the type of mixed circuit is selected.

The system specific default parameters include the appropriate flow temperature control, system heat-up times and define the system response to changing outside temperatures.

Supply from external sources can be used, too. But in this case, the flow temperatures cannot be influenced.



Relevant parameters:

Web page:

Home → Installer → Settings → Mixed circuits

App:

Settings → Installer → Control parameter → Submenus

04.03 Heating mode

04.03.01 Start and stop of heating mode

Heating mode of the system may be started and stopped depending on the following conditions or parameters:

- Selected operating mode by user
- Defined heating or cooling period
- Filtered outside temperature, maximum outside temperature at which heating is deactivated and applied hysteresis function
- Actual comfort level
- Temperature in rooms which are defined as "pilot rooms"
- External input signals which are defined as HEATING or COOLING

Selected operating mode

Heating mode can be started only when the system is set to HEATING / COOLING, only HEATING or MANUAL HEATING.

Defined heating or cooling period

When there is a definition for heating period, heating mode is started only during this period. Heating mode is also not started when system is in a defined cooling period.



This limitation is ignored when manual heating mode is selected. Freeze protection is always active.

Filtered outside temperature, heating limit and hysteresis.

The information about outside temperature may come from a wireless or wired probe which is installed outside the building. When the system is connected to internet there is the option to use weather service. The outside temperature is timely filtered with a time constant, by default set to 48 h.

When the filtered outside temperature drops below the heating limit, heating mode is started.



Relevant parameters:

Web page:

Home → Installer → Settings → Heating / Cooling Settings

App:

Settings → Installer → Control parameter → Heating

Figure 04-1 shows an example of a 5-day period:

The heating limit is 15 °C during energy level NORMAL and 13 °C during HOLIDAY / ABSENCE (see next paragraph). The hysteresis is 0,5 K.

The filtered outside temperature is displayed in the blue dotted line.

Between day and night there is a temperature difference of around 8 K, in the early morning hours of day 1 and 2 the temperature is around 12 °C, at day it reaches more than 20 °C. The filtered outside temperature touches the heating limit, but the integrated hysteresis avoids start of heating mode.

In the night to day 3 there is a temperature drop down to 7 °C, the next 2 days reach in the afternoon almost 15 °C and then even 17 °C, but the tendency is to cooler days.

Heating mode is started in the morning of the third day.

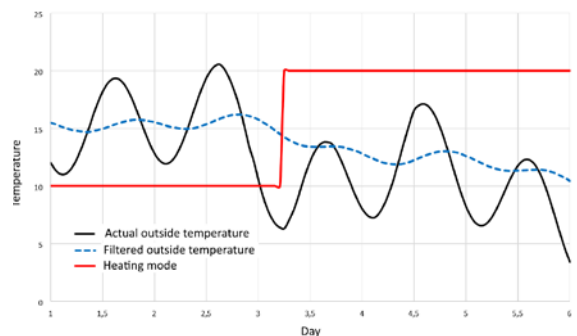

Fig. 04-1 Heating mode started by filtered outside temperature

Influence of energy level

The heating limit is shifted from 15 °C to 13 °C (both values are the default settings) when all rooms, which are defined as pilot rooms, are in absence (holiday) mode.

Influence of pilot rooms

The actual room temperature in the pilot rooms shifts the heating limit upwards (heating mode starts earlier), as soon as one of the pilot rooms is below his setpoint temperature. The "worst" difference to set point is taken, in default setting each Kelvin shifts the heating limit by 1 Kelvin.

The shift is limited to ± 3 K.



Only rooms which are too cold are considered. The degree of this influence is determined by parameter "economy" which can be set by the user between the minimum and maximum values "high comfort" and "economy".

External input signals HEATING, COOLING

When the NEA SMART 2.0 system is part of a superordinated system – e.g. a heat pump which supplies several apartments – it must follow the overall operation mode.

This can be done by connecting potential free switches (dry contacts) to the digital inputs and configuring them for HEATING or COOLING.

Allowed mode	Input HEATING		Input COOLING	
	existing	State	existing	State
H / C	-	-	-	-
H	x	ON	x	OFF
C	x	OFF	x	ON
none	x	OFF	x	OFF
H	x	ON	-	-
C	x	OFF	-	-
C	-	-	x	ON
H	-	-	x	OFF
none ¹⁾	x	ON	x	ON

¹⁾ Combination is not allowed, heating and cooling is blocked

Tab. 04-1 Allowed operation modes

Parametrization of mixed circuits in heating mode

The calculated set point for the flow temperature, which is controlled by the mixed circuit is influenced in heating mode mainly by the following values and parameters:

- Outside temperature, timely filtered
- Settings for heat curve
- Pilot room conditions

In the configuration sequence, each mixed circuit is selected for a specific heating system. The parameters which are pre-set for this application can be individually adapted to the characteristics of the supplied heating system, the needs of the building and the rooms to be supplied.

Here is some more detailed information about the relevant parameters.

Filter time constant for outside temperature:

a low filter time constant ("low" means short time, e.g. between 2 and 8 hours) allows a quick reaction to outside temperature jumps for fast reacting systems as ceiling system or underfloor system with thin heating elements.

Minimum and maximum flow temperatures:

adaption to energy need or to special floor covering (wooden floor).

Starting point and slope of heat curve:

adaption to energy need.



Relevant parameters:

Web page:

Home → Installer → Settings → Mixed circuits

App:

Settings → Installer → Control parameter → Heating → Mixed circuits

04.03.02 Influence of pilot rooms

Pilot rooms influence the set point of flow temperature in the following way:

- When one of the pilot rooms is too cold – where the definition of "too cold" is influenced by the "economy" parameter, the flow temperature is increased
- When there is no pilot room which is really "too cold", the flow temperature is not adjusted
- When the pilot rooms are in general too warm, the flow temperature is reduced.

The degree of adjustment can be set by parameter.



Relevant parameters:

Web page:

not available

App:

Settings → Installer → Control parameters → Heating - Heating circuits

04.03.03 Boost function

Depending on the calculated flow temperature, the system expects a certain level of return temperature.

When the temperature of the heating elements is too low, because there was a longer pause time of heating mode or the heating mode just has been started, the difference between flow and return temperature will be higher than the calculated limit value. If this situation continues for a time span of 30 minutes, the flow temperature is increased for 30 minutes to speed up the heat up process.

After these 30 minutes, the boost function is blocked for the next 30 minutes.



Relevant parameters:

Web page:

not available

App:

Settings → Installer → Control parameters → Heating - Heat up

04.04 Cooling mode

Cooling mode of the system may be started and stopped depending on the following conditions or parameters:

- Selected operating mode by user
- Defined heating or cooling period
- Calculated cooling criterion
- External input signals which are defined as HEATING or COOLING

Selected operating mode

Cooling mode can be started only when the system is set to HEATING / COOLING, only COOLING or MANUAL COOLING.

Defined heating or cooling period

When there is a definition for cooling period, cooling mode is started only during this period. Cooling mode is also not started when system is in a defined heating period.

04.04.01 Cooling criterion

The cooling criterion is a value derived from a set of different conditions – outside conditions and conditions in the pilot rooms – the overall need to start cooling mode.

The cooling criterion is calculated out of the following values:

- Outside temperature (current value) and a reference value for this
- Filtered outside temperature and a reference value for this
- Pilot room temperatures and their set points in cooling mode¹⁾
- Trend of the pilot room temperatures¹⁾
- Weighting parameters for the above named values

¹⁾ When no pilot rooms are defined, this influence does not exist.

By using the weighting parameters, it is possible to adapt the way that cooling mode is started to the needs of the user and the characteristics of the building. Of course, the setting has a decisive influence on the energy usage of the building on one hand and the comfort conditions on the other hand.

A weighting parameter may also be set to zero to eliminate the influence of a certain value.

The standard reference values are:

Actual outside temperature: 24 °C

Filtered outside temperature: 18 °C



Relevant parameters:

Web page:

not available

App:

Settings → Installer → Control parameters → Cooling - Heating → General

Examples for cooling criterion settings

Example 1:

- Type of application: Good insulated office building with heavy internal loads.
- Demands: High importance of comfortable room temperatures.
- Conclusion: Outside temperature has no decisive influence, the focus is on the room temperatures.
- Setting: Reduce reference values for actual value of outside temperature to 20 °C, for filtered value to 16 °C. Reduce weighting factors for both. Increase weighting factor for pilot rooms.

Example 2:

- Type of application:
Very well insulated residential building
- Demands:
Energy usage for cooling mode should be reduced.
Free cooling is preferred. Temporarily too high room temperatures can be accepted.
- Conclusion:
Use cooling mode only when outside temperature is too high for free cooling.
- Setting:
Reduce weighting factor for pilot rooms.

Example 3:

- Type of application:
Show room with big glass fronts.
- Demands:
Energy usage for cooling mode is not so relevant.
Room temperatures have to be comfortable.
- Conclusion:
Allow cooling mode all the time outside heating period.
- Setting:
Set reference value for filtered outside temperature to 16 °C.



In order to avoid unnecessary energy consumption, a minimum running time for cooling mode (standard value 60 minutes), and a blocking time (default value 12 hours) for switching between heating and cooling mode is set.

04.04.02 Flow temperature set point in cooling mode

The calculation of flow temperature set point in cooling mode must take into account the following demands:

- Avoid condensation on cooled surfaces
- Ensure user comfort
- Cooling system characteristics

General limit

The lowest set point of flow temperature is defined by a system-specific parameter.

Condensation

The system receives from the installed room units with humidity sensor the information "relative humidity" and "dew point".



Both values are used for dehumidifier control, see chapter 9 Parameter.

The highest dew point from all rooms which belong to a mixed circuit is selected and a safety offset is added. Flow temperature may not drop below this limit.



Relevant parameters:

Web page:

Home → Installer → Settings → Mixed circuits

App:

Settings → Installer → Control parameter → Cooling → Circuits

User comfort

Surfaces which are too cold will cause uncomfortable conditions, especially in floor cooling systems. To avoid this, the minimum flow temperature is set according to the cooling system characteristics.

Note:

An additional sensor can be connected to the room unit to monitor the temperature of the cooled surface. User may set a limit value; the temperature of the cooled element will not fall below this value in cooling mode.



A sufficient safety margin to calculated dew point must be selected according to the conditions in the installation.

It has to be taken into account that

- as a matter of principle, all measured values have a certain degree of inaccuracy
- the surface temperature of the cooled areas may be close to the flow temperature, depending on ambient conditions
- a correction of flow temperature due to a rapidly increasing room humidity has not an immediate effect on the surface temperature. Depending on the system used the reaction will only take place after a certain period of time
- condensation on cooled elements can damage structure, surface and appearance of these elements
- condensation on cooled floors can cause accidents due to slippery surface

04.04.03 Dew point monitor

The potential free output contacts of dew point monitors can be connected to Base, R-Module and U-Modules configured for mixed circuit control.

They shall be installed on pipes which carry water with the lowest temperature. It must be ensured, that the mounting position allows air circulation and that the humidity conditions are representative for the cooled environment.

Triggering of a dew point monitor results in the following actions:

- if the dew point monitor is connected to an U-Module for mixed circuit, the mixed circuit is stopped and the valves of all rooms supplied by this mixed circuit are closed
- if the dew point monitor is connected to a NEA SMART 2.0 Base or a NEA SMART 2.0 R-Module, the valves of all rooms controlled by these units are closed
- all dehumidifiers that are assigned to affected rooms are started

04.04.04 Dehumidifiers

The system can control up to 9 dehumidifiers. Dehumidifiers can be controlled by the bases (each base 1 dehumidifier) and the U-Modules (2 dehumidifiers per U-Module).

Dehumidifiers are assigned to rooms, whereby several rooms may have access to the same dehumidifier. It is not possible to assign more than one dehumidifier to one room.

A dehumidifier is started when with at least one assigned room:

- Relative humidity is above a limit value, or
- Calculated dew point is above a limit value, or
- There is a dew point alarm by a dew point monitor

To reduce potential noise pollution caused by running dehumidifiers at otherwise quiet times, a weekly program can be used to start the dehumidifiers during "quiet times" only when a 2nd, higher limit of relative humidity or dew point is exceeded.

Dehumidifier control

For each dehumidifier 2 outputs of the system may be used:

▪ Hydraulic:

This signal opens a valve which allows the supply of a heat exchanger which is integrated in the dehumidifier. The use of this signal is optional and depends on the type of dehumidifier used. This signal is activated first.

▪ Compressor:

Starts the compressor. When the "hydraulic" signal is defined, the compressor signal is delayed for 3 minutes.

Dehumidifiers have minimum and maximum run time. After stopping a dehumidifier, there is a minimum pause time before restart.



A dew point alarm by dew point monitor always starts the dehumidifier.

Dehumidifiers are normally used only in cooling mode. For special applications as e.g. swimming halls dehumidifiers can be configured also to be operated outside cooling mode.



Relevant parameters:

Web page:

Home → Installer → Settings → Devices

App:

Settings → Installer → Devices → Cooling → Dehumidifiers

04.04.05 Summer compensation

To avoid an excessive difference between the outside temperature and the temperature in cooled rooms, the room temperature set point can be increased sliding up to a maximum value of 26 °C when a certain outside temperature is exceeded.

This is an option, which can be activated and adjusted by the user.



Relevant parameters:

Web page:

not available

App:

Settings → Installer → Control parameter → Cooling → General

04.05 Supply control of heat and cool media

This chapter describes how the system controls the supply of heated or chilled water for heating / cooling surfaces, dehumidifiers and fan coils.

The graph below shows the principle logical order of demand signals.

Starting point is the "energy consumer". This can be e.g. a room which is heating or a dehumidifier which demands cooling water.

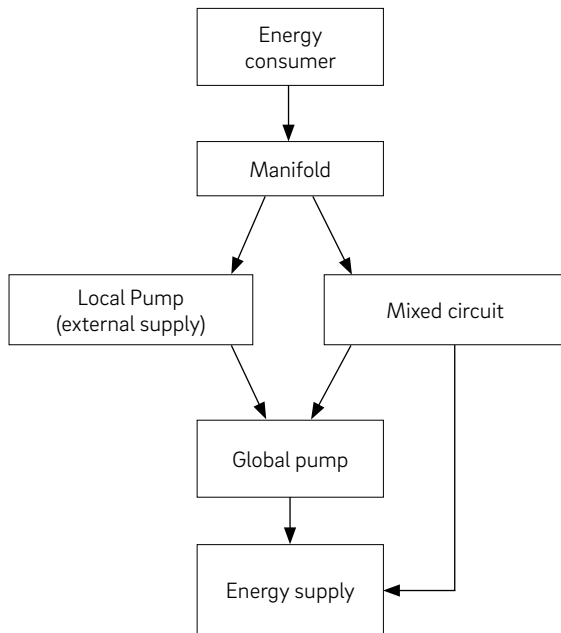

Fig. 04-2 Flow of energy demand signals

Not each element which is shown in the graph must be defined in system configuration.

04.05.01 Manifold selection

Each circuit of a room, the hydraulic connection of a dehumidifier or the supply of a fan coil is assigned to a specific manifold.

The manifold is assigned to a mixed circuit or to an external source.

04.05.02 Pump control

The following pumps can be controlled:

- Local pumps, controlled by Base or R-Module.
- These pumps are assigned to the rooms, which are controlled by this Base and his R-Module
- Pumps of mixed circuits, controlled by U-Module
- One global pump, controlled by Base or R-Module



A local pump is started if this base or the associated R-Module is assigned

- to Rooms send a request or
- to dehumidifier operate the „hydraulic valve“ in cooling mode

The global pump as a central supply pump is started, when one of the other pumps is running.

The pump run times are determined by the classification of the pump as conventional or high efficiency pump.

04.05.03 Mixed circuits

Up to 3 mixed circuits can be controlled by the system, each mixed circuit is controlled by an U-Module, configured for this use.

A mixed circuit can be configured for:

- Heating only
- Heating and cooling
- Cooling only

For the supply of the following systems:

- Underfloor
- Wall
- Ceiling

The parameters which influence the flow temperature are set according to the operational purpose of the mixed circuit, but can be adapted individually.



Relevant parameters:

Web page:

Home → Installer → Settings → Mixed circuits

App:

Settings → Installer → Control parameter → Cooling → Circuits

Settings → Installer → Control parameter → Heating → Circuits

04.05.04 Boiler and chiller control

The boiler and chiller demand signal is an on/off signal coming from a potential free contact of the Base.

The signal is triggered at the end of the logical chain shown in figure 04-2 under consideration of minimum run time and pause time.



The demand signal of a mixed circuit is created only when the opening of the mixing valve exceeds a minimum level.



Relevant parameters:

Web page:

Home → Installer → Settings → Devices

App:

Settings → Installer → Devices → various Submenus

04.06 Room temperature control

04.06.01 Adaption to used system

The parameters, which influence the control behavior, are pre-set automatically when the system (floor / wall / ceiling) is selected.

The parameters for the system in general can be adapted, but not for each room individually.



It is possible, that in one room there are different heating and cooling systems.

Each system has its own parameter set. This means, that in one room there are up to 3 PI control mechanism running independent from each other.



Relevant parameters:

Web page:

Home → Installer → Settings → Control

App:

Settings → Installer → Control parameter → Rooms

04.06.02 Controller type: Proportional – Integral (PI)

Room temperature control works on base of a proportional – integral (PI) controller. The proportional part of the control signal gives an immediate reaction when the difference between set point and actual value changes.

The integral part changes slowly and has the objective to eliminate the remaining difference between set point and actual value. To avoid negative effects, caused by the thermal storage of the used system, there are some special rules implemented, how the I-part is calculated.



Relevant parameters:

Web page:

Home → Installer → Settings → Control

App:

Settings → Installer → Control parameter → Rooms

04.06.03 Valve control by PWM method

The calculated controls signal, which is a value from 0 % to 100 %, is transferred to the puls-width-modulation (PWM) method.

PWM method means, that the valves of the manifold, which control the flow of heating and cooling medium, are opened in a percentage of the PWM cycle time, which is equivalent to the control signal calculated by the PI controller.

Figure 04-3 shows a control signal of 100 %, 50 % and 20 % and the principle how it is transferred to a PWM signal.

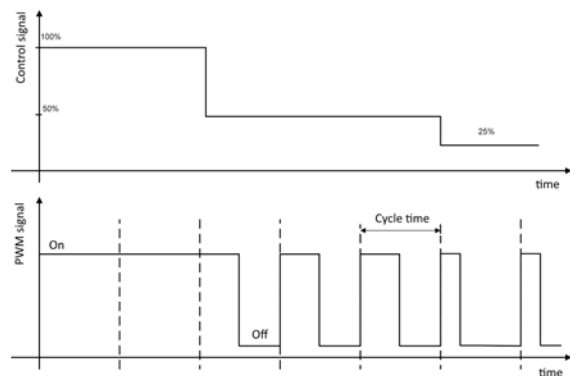

Fig. 04-3 Control signal and corresponding PWM signal

There are minimum times to switch the thermal actuators for the valves on or off which have its reason in the opening and closing times of the actuators.

Typical cycle times are 20 minutes for floor and wall systems, 10 minutes for ceiling systems.



Relevant parameters:

Web page:

Home → Installer → Settings → Control

App:

Settings → Installer → Control parameter → Rooms

04.06.04 Overview of individual room settings

The figure below is taken from the installation wizard and shows room individual settings:

The screenshot shows the 'Rooms' configuration page for a 'Livingroom' with a temperature of 22.5. The interface includes several settings with callouts:

- 1**: Heating and cooling set points (26.0 and 19.0).
- 2**: Holiday mode set points (24.0 and 26.0).
- 3**: Fan coil supply set point (15.0).
- 4**: Weekly program (1).
- 5**: Dehumidifier (No dehumidifier).
- 6**: Fancoil No. fancoils (CC Channel used).
- 7**: Fancoil Supply (Pump).
- 8**: Fancoil System (Cool).
- 9**: Fancoil Tolerance (ECO).
- 10**: Fancoil Active in Reduce (checkbox).
- 11**: Fancoil Stop (checkbox).
- 12**: Enable auto start (checkbox checked).
- 13**: Pilot room (checkbox).
- 14**: Heating (checkbox checked) and Cooling (CO) (checkbox checked).
- 15**: Function of additional input (P2).
- 16**: Remote temperature (21.3), Remote sensor high limit (heating) (30.0), Remote sensor low limit (heating) (20.0), and Remote sensor low limit (cooling) (19.0).

Other visible settings include Humidity: 44 %, Display lock (checkbox), and a 'Confirm' button at the bottom.

Fig. 04-4 Room configuration page

- 1** and **2** are the set points which belong to heating and cooling mode for the energy levels NORMAL (room is used) and REDUCED (room is not used at this time)
- 3** is the set point for holiday mode (absent)
- 4** is the weekly timing program which switches in timer mode between NORMAL and REDUCED
- 5** selected dehumidifier
- 6** assigned fan coil
- 7** supply of fan Coil
- 8** using heating, cooling or heating / cooling
- 9** selection comfort level of fan coil
- 10** activation of the fan coil during reduced mode
- 11** lock fan coil
- 12** is the optimization method "Autostart" which optimizes the transition between reduced and normal mode
- 13** Pilot rooms influence flow temperature and the activation of heating and cooling mode
- 14** is the activation of heating and cooling mode
- 15** Function of external input of room unit (in this case temperature limitation of floor), see more in chapter 07.04.06
- 16** Limits of floor temperature for heating and cooling mode

04.06.05 Timer programs

Daily and weekly programs are predefined but can be changed. From the 10 available daily programs, 5 different weekly programs can be put together, with a different daily program for each day.

For typical applications, it is sufficient to use one or two of the weekly programs and assign them to the different rooms (see **4**).

It is also possible to use for a room not one of the weekly programs, but for each day of the week one of the 10 daily programs.

When the room is running in timer mode, the set points, which are defined in **1** and **2** are used in normal and reduced energy level.

See next chapter for optimization of transition between normal and reduced energy levels.



The energy level of the rooms determines the operating of the assigned mixed circuit. As long as there is a room in energy level NORMAL, the supply by the mixed circuit is running in the NORMAL condition.

04.06.06 Auto start function

The auto start function uses a permanently updated set of data, which contains the heat up/cool down gradient of room temperature for different outside temperatures. These gradients are individual for each room.

When activated , the system tries to reach the next set point at the time which is defined in the timing program.

The auto start function is used in heating and in cooling mode. It has to be differed between the transitions from REDUCED to NORMAL (case A) and NORMAL to REDUCED (case B).

Case A, transition REDUCED → NORMAL:

Based on the gradient, which is valid at this time due to actual outside temperature, the system calculates the time which is needed to reach the desired set point, beginning from the actual room temperature value.

Example for heating mode:

The gradient corresponding to the outside temperature is 0.8 K/h. The current temperature in reduced mode is 19.4 °C. The set point for NORMAL is 21 °C, the „NORMAL“ operation should start at 7:00 a.m. This means that the heating-up phase starts 2 hours earlier – plus a safety surcharge.

Case B, transition NORMAL → REDUCED

The behavior is influenced by the „Comfort Level“ parameter, which influences the positioning of the system between the extreme positions „highest comfort“ and „most economical operation“.

Depending on this setting, the system will sooner or later switch to the reduced operation and accepts a more or less large deviation between set point and actual value.

04.06.07 Pilot rooms

Rooms selected as pilot rooms  impact on

- Heating limit (see chapter 9 Parameter)
- Flow temperature in heating mode (see chapter 9 Parameter)
- Cooling criterion (see chapter 9 Parameter)



The number of pilot rooms is not limited. Only rooms which are regularly occupied / in use should be selected as pilot rooms.



Relevant parameters:

Web page:

Home → Rooms

Home → Installer → Rooms

App:

Settings → Installer → Control parameter → Heating → Heating circuits

Settings → Installer → Control parameter → Cooling → General Parameters

04.06.08 Parameter “economy”

The parameter “economy” influences the system behavior in several points, changing the energy usage and comfort. The parameter can be modified by user between the values 0 to 10 by the user.

0 – maximum comfort

5 – balanced between comfort and economy (default value)

10 – maximum economy



Relevant parameters:

Web page:

not available

App:

Settings → Installer → Heating / Cooling

04.06.09 User settings and operating

The user can change set points, operating mode and parameters, which influence room temperature control, using:

- NEA SMART 2.0 App
- Integrated web pages
- NEA SMART 2.0 Room Units

Only with the NEA SMART 2.0 App is access to the full range of parameters possible. Important parameters can be modified using the web pages and only essential parameters can be accessed directly through the room units themselves.

Using the room units the following settings can be modified:

▪ temporary change of set point:

If the room unit is in TIMER mode, a change in setpoint will only remain effective until the next programmed temperature change.

▪ permanent change of set point for NORMAL or REDUCED mode:

If the room is in NORMAL or REDUCED mode, the selected new setpoint will be remain effective indefinite for the current mode

▪ change of energy level

Energy level can be changed between:
NORMAL / REDUCED / STANDBY

The selected energy level remains active until the unit is switched into TIMER mode and a change in energy level is triggered.

- **activation of TIMER program** (selection of energy level by weekly program)
- **activation of PARTY mode:**
PARTY mode uses NORMAL energy level for a time span of 4 h (default value), if you select party mode via the room unit)



All changes made via a room unit are only effective for this single room.

04.06.10 Remote temperature probe for room units

All room units feature an additional input, which accepts a remote temperature probe or a digital input.

For digital inputs see chapter 04.07.01

With a temperature probe the following functions is possible:

- **Limiting of minimum and maximum floor temperature:**
minimum value for cooling and maximum value for heating – or – 2 minimum values for cooling or maximum value for heating
- **Additional room temperature input:**
room temperature is taken as the average reading additional from room unit and remote probe
- **Floor temperature control:**
room is solely controlled via floor temperature
- **Condensation protection for chilled ceilings:**
Probe can be attached to chilled ceiling element or to flow pipe. Assigned valve is closed when temperature comes close to dew point of this room, more information are in chapter 7.4.6.

04.06.11 Rooms with various heating / cooling systems

As described in chapter 04.02.01 and 04.02.02 a room may have different systems in terms of type (floor, wall, ceiling) and in terms of operating mode (heating, cooling, heating and cooling).

For each system there is an individual set of parameters which considers the specific properties for room temperature control.

Example:

A room with a floor system (heating only) and ceiling system (cooling only).

The ceiling system is based on plasterboard, the floor system is a common screed based system. The thermal masses of floor and ceiling system are very different. Because of this, the response time of the ceiling system is much faster. This is taken into consideration through the different pulse width cycle times for each system: default value for floor system is 20 minutes, for ceiling system 10 minutes.



For each system, a separate channel (Room-Zone, RZ) on the Base or the R-Module is required to ensure:

- the valve actuators can be connected directly to the output of the Base without using any additional relays to switch the
- output signal - the heating / cooling systems are supplied according to their respective requirements

With NEA SMART 2.0 it is possible to assign a single room unit to multiple channels across a base station and any directly connected R-Module. Each channel can then be assigned to a different system.

It is not possible to assign a Room Unit or Room Probe to more than one Base and the directly connected R-Module.

04.06.12 Geofencing

Geofencing is a smart option of the NEA SMART 2.0 App to allow automatic reduction of energy use when the user is a minimum distance away from home.

The method is based on an evaluation of the geographical position and movement of the user, calculating the expected earliest time of return.

The function can be enabled individually for each smart device the NEA SMART 2.0 App is running on.

The default setting for this function is "disabled".

Activation of the energy saving reduced set point is only applicable to rooms which are operating in TIMER mode.

The decrease in set point is limited to ensure the normal set point temperature can be reached again in time for the occupants return.

04.07 Digital input and output signals

The digital input and output signals of NEA SMART 2.0 System allow

- Activation of devices such as pumps, boiler, chiller, dehumidifier and fan coils
- Switching of valves
- Communication of status / operating mode
- Receiving warning / alarm information
- Receiving status information from a superordinated system



This chapter describes customisable input/output signals which are not part of a pre-defined control function that exist for flow temperature and control of dehumidifiers.

04.07.01 Digital input signal



The digital inputs require a potential free switch (dry contact).

INPUT signal	Available on	Reaction
Dew point monitor	Room unit	Cooling of this room is stopped, associated dehumidifier is activated.
Note: Dew point monitor signal is triggered when the potential free switch is open	Base, R-Module	Cooling of all rooms assigned to the base and to connected R-Module is stopped, associated dehumidifiers are activated.
	U-Module (mixed circuit)	The operation of mixed circuit is ended.
Window contact	Room unit	Heating / cooling is stopped for 30 minutes. After this, energy level of this room is switched to REDUCED.
Note: Window contact signal is active when the potential free switch is open	Base, R-Module	For all rooms assigned to the base and to connected R-module the same measures as described above apply.
HEATING	Base, R-Module	System is restricted to operating modes neutral or heating. The mode heating / cooling (automatic mode) may be activated, but cooling will not start as long as the input signal HEATING is active.
COOLING	Base, R-Module	System is restricted to operating modes neutral or cooling. Heating / cooling (automatic mode) may be activated, but heating will not start as long as the input signal COOLING is active.
Energy Level REDUCED LOCAL	Base, R-Module	All rooms ¹⁾ which are in TIMER mode go to energy level REDUCED.
Energy Level REDUCED GLOBAL	Base, R-Module	All rooms ²⁾ which are in TIMER mode go to energy level REDUCED.
Energy Level ABSENCE	Base, R-Module	All rooms ²⁾ which are in TIMER mode go to energy level ABSENCE.

Tab. 04-2 Available digital input signals and system reaction

¹⁾ Applied to all rooms assigned to this Base and R-Module

²⁾ Applied to all rooms in the entire installation

04.07.02 Digital output signal

OUTPUT signal	Available on	Trigger
Pump local	Base, R-Module	A room assigned to this base or a connected R-module has a current demand signal (heating or cooling) or a dehumidifier allocated to the base or connected R-Module triggers the "hydraulic" valve (only in cooling mode).
Pump global	Base, R-Module	Any room of the entire installation has a current demand signal (heating or cooling) or any of the dehumidifier triggers the "hydraulic" valve (only in cooling mode).
Pump mixed circuit	U-Module (configured for mixed circuit)	Demand signal for mixed circuit has been generated.
Boiler	Base, R-Module	A room of the entire installation not supplied via a mixed circuit triggers a heating demand signal or any of the mixed circuits causes the mixing valve to open by more than the pre-defined amount/level.
Chiller	Base, R-Module	Same as above, but for cooling demand signal.
HEATING	Base, R-Module	System is in heating mode. Can be used to control the operation mode „heating“ to other devices or to a BMS.
COOLING	Base, R-Module	Same as above, but for cooling.
Valve dehumidifier	Base, R-Module, U-Module	Dehumidification sequence started. Valve opens before compressor starts.
Compressor dehumidifier	Base, R-Module, U-Module	Dehumidification started.
Alarm	Base, R-Module	Error signal.
Fan Coil	Base, R-Module, U-Module	Fan Coil operation has been requested.
Fan Coil Pump	Base, R-Module, U-Module	Fan Coil operation has been requested.

Tab. 04-3 Available digital output signals and the condition to activate them

04.08 System operating and monitoring

There are 3 ways to operate and monitor the system:

- Via NEA SMART 2.0 App
- Via integrated webpages (only when user is in the building itself)
- Directly via the Room Units

04.08.01 Using the room units

Room units can be used for:

- Changing actual set point (temporary)
- Changing set points for NORMAL and REDUCED energy level of actual operating mode (permanent)
- Change between energy levels NORMAL, REDUCED and STANDBY
- Activation of TIMER or PARTY mode
- Display and confirm messages (open window, condensation problem, error code)



To avoid unwanted or inadmissible settings, minimum and maximum values for set points can be defined. Additionally, the buttons of the Room Units can be locked. For public areas, the remote Room Probes can be used which look identical to the room units but have no display or operating buttons.

04.08.02 Integrated web pages

The NEA SMART 2.0 Base has an integrated web server, with web pages in 14 languages.

The web pages can be accessed by WLAN or LAN with any device by a web browser inside the house.

The web pages can be used by the installer for setting up the system, check functionalities and modify important parameters.

The user can change energy level (for entire installation or for each room individually), operating mode, set points, timer programs and some parameters.



The web pages can be accessed only when the Base is in "access point mode". It is not possible to use the NEA SMART 2.0 App at the same time.

04.08.03 Installer only web pages – Commissioning wizard for global system set-up

To facilitate an easy, quick and reliable commissioning process, the system has got a built in wizard which guides the installer through the setup.

The correct running the Wizards ensures that

- all installed system components are detected and the system can access them
- all physical and logical connections between components and any external devices are checked and work correctly
- relevant settings and parameters are customised to the installation



Installations with only a single NEA SMART 2.0 Base station and one R-Module, the system can be initiated without using the wizard.

However, the following limitations will apply:

- the system can only control room temperatures
- only heating mode is possible
- Timing programs cannot be used (system date and time is not set)

It is recommended to always use the wizard.

Pre-requisites for running the wizard:

- Hardware installation completed
- All communication bus connections are made and checked
- Room Units, Room Probes and outside temperature sensors are paired

It is highly recommended to have all devices, such as pumps, actuators, boiler, chiller, dehumidifiers fully connected to the system to enable complete testing of all connections and functions.



The connection of sensors such as outside and flow temperature sensors, which are required for a mixed circuit, is mandatory. The wizard cannot be completed if important signals are missing.

To run the Wizard, the Master Base, is set to access point mode (point to point connection to one device only).



The system master is defined by the system bus address setting 0000.

It is possible, to connect by LAN or WLAN, in most cases a smart phone, tablet or laptop is used, connected by WLAN.

For details how to connect see chapter 7 System set up.



The wizard starts automatically when an unconfigured NEA SMART 2.0 system is switched on.

The commissioning wizard checks for consistency at preset point within the commissioning process and holds the process or prevents the system from starting up if the connected components do not match the entered configuration.

Main steps in wizard:

- Selection of language, type of installation, building type and energy standard. System date and time is taken from the connected smart device.
- Definition of connected devices, functions and number of manifolds and rooms.
- Automatic verification if desired functions are achievable within the defined hardware environment.
- Scanning and verification of components via System Bus or Zone Bus.
- Parameterisation of all U-Modules (control of mixed circuit, dehumidification control or fan coil).
- check of all the used inputs and outputs of U-Modules.
- Definition of rooms and their operating modes (heating/cooling), connection to manifolds.
- Definition of input and output signals of Base(s) and R-Modules.
- Final verification check if all desired functions are possible and activation of the system.

04.08.04 Installer only web pages – Room setup and parametrization

After successfully completing the commissioning wizard, an installer can assign room names, select from a range of extra options for the rooms (assign pilot role, enable auto start function), modify and allocated timer programs.

The installer only web pages also give access to a selection of parameters. The complete set of parameters can be accessed via NEA SMART 2.0 App.



Room management and certain settings are accessible in user level, but with some restrictions.

04.08.05 User Web pages



The user may operate the system via integrated web pages if he does not want to connect his system to a cloud and to use the NEA SMART 2.0 App.

In this case a tablet permanently connected to the NEA SMART 2.0 Master Base is the recommended solution.

Main functions:

- Select energy level for entire installation or for each room individually (NORMAL, REDUCED, HOLIDAY / ABSENCE)
- Select operating mode (heating manual, only heating, cooling manual, only cooling, automatic mode)
- Select PARTY mode
- Monitor actual room temperatures and humidity
- Define room temperature set points for above named operating modes and energy levels
- Change temporary room temperature set points
- Edit timing programs and assign them to rooms and dehumidifiers
- Define heating and cooling period
- Modify starting points for heating / cooling mode
- Define minimum / maximum values for floor temperature
- Manage access to cloud via router

04.08.06 NEA SMART 2.0 App

To use the NEA SMART 2.0 App, it is necessary to connect the Base (only the system master) to a router and to establish the connection to the cloud.

The NEA SMART 2.0 App is not only the most comfortable way for the user, to operate and monitor his system, it is also the most powerful tool for installers and service engineers, to analyse the behaviour of the system, optimize it and detect potential problems.

The app offers – beside all above listed features of the web pages – the following additional functions:

- Easy and intuitive operation of the system independent of location
- Automatic activation and deactivation of reduced energy level by locating user and identifying his distance to his home (geofencing)
- HOLIDAY function with calendar
- Statistics of room temperatures, humidity and heating / cooling behaviour

- Tips for optimization potential and recommended maintenance actions
- Remote diagnostic by service engineers (when this is activated)
- Advanced setting and parametrization

04.08.07 Warnings and alarm functions

The warning or alarms listed below are displayed on the room unit via a symbol or error code:

- Open window detected
- Risk of condensation
- Low battery of wireless Room Units
- Connection failure of Room Unit
- Frost protection function activated
- Probe failure

More detailed error messages are shown in the App, the room unit will only display "E99".

04.09 System response in case of fault

When the system detects a problem e.g. a communication failure or a defective probe, a message is triggered, and the fail safe mode is activated.

The fail safe mode is designed to avoid any damages to the building and – if possible – ensure a minimum of comfort.

04.09.01 Communication problems

Communication loss with room unit

The communication failure may be caused by almost empty batteries in case of wireless Room Units or Room probes or by a damaged Zone Bus system.

After 1 hour of communication loss the NEA SMART 2.0 Base reports this via a flashing LED corresponding to the channel experiencing the issue. The room will be heated in emergency mode (80 % of last heating power). Cooling is stopped.

Communication loss between system components (SYSBUS)

The System Bus connects the NEA SMART 2.0 Base units and the U-Modules.

The connected components enter a fail safe mode to avoid damages and to ensure comfortable conditions as far as possible. But it is not possible in this case to operate the complete system via App or integrated web pages.

04.09.02 Probe faults

Room temperature probe defective

Same reaction as "Communication loss of room unit".

Room humidity probe defective

Cooling of this room is stopped to avoid condensation problems. In heating mode there is no reaction except the error message.

Outside temperature probe defective or no signal

The system reacts as if outside temperature would be 0 °C.

Flow temperature probe defective

In heating mode, the mixing valve is set to 10 % open, the mixed circuit keeps on running.

In Cooling mode the mixed circuit is closed.

04.09.03 Control issues

Heating mode: Flow temperature too high

As long as the flow temperature does not exceed the defined maximum value for this circuit, the mixed circuit keeps on running. When the flow temperature is above this value, the mixed circuit will be closed down. The magnitude of deviation determines how fast this is done.

If the flow temperature is 15 K above the maximum permissible value, the mixed circuit is stopped immediately.

Cooling mode: Flow temperature is below calculated dew point of one or more rooms

Valves of these rooms are closed.¹⁾ This prevents that one or more rooms are supplied with water, which could cause condensation problems.

¹⁾ It is possible that during commissioning the safety offset for the flow temperature in relation to the dew point was set to zero or even a negative offset. In such a case the valves would be closed every time the flow temperature drops below the set point.

Cooling: Flow temperature too low

If the calculated set point is permanently undershot, the mixed circuit is switched off after a period of time, the time to shutdown depends on how strong the deviation is.

If the flow temperature falls by more than 4 K below the minimum value defined for this circuit, the circuit is switched off immediately, as well as if the flow temperature rises more than 15 K above the maximum value defined for heating mode.

04.09.04 Other issues

Open window detected

It has to be differentiated between these cases:

1. Automatic detection by room unit In heating and cooling mode, for 30 minutes heating and cooling is stopped and then continued with previous energy level.
2. Window dry contact connected to room unit In heating mode, for 30 minutes heating is stopped and then continued with REDUCED energy level. In cooling mode, cooling is stopped and not started again until the window is closed.
3. Window dry contact connected to base or R-Module In this case the window contact is assigned to a room and behaviour is the same as in case 2).

Condensation problem detected

It has to be differentiated between these cases:







1. Detection by room unit (high humidity) or by a dew point monitor connected to room unit: Cooling of this room is stopped. Assigned dehumidifier is started.

2. Detection by dew point monitor connected to base or to R-Module: Cooling of all rooms connected to this Base and R-Module is stopped. Mixed circuits linked to this Base or R-Module are stopped. Assigned dehumidifiers are started.
3. Detection by dew point monitor connected to U-Module for mixed circuit: Mixed circuit is stopped. Cooling of all rooms connected to this mixed circuit is stopped.

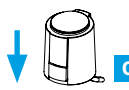
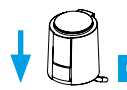
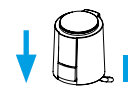
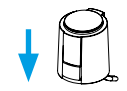
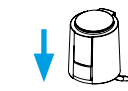
Frost protection

The frost alarm symbol is shown when the room temperature drops below 5 °C.

When there is no heating mode active at this moment, (because e.g. system is in STANDBY), heating is started with a set point of 5 °C.

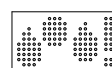
	Source of signal	NEA SMART 2.0 Room Unit			NEA SMART 2.0 Base	NEA SMART 2.0 U-Module for Mixed Circuit	
Signal	Type of signal:	Relative humidity of Room Unit	Dew point calculated in Room Unit	Dew point monitor of Room Unit (input selection P6)	External probe connected to Room Unit (input selection "Ceiling Protection" P8)	Dew Point monitor connected to digital input	Dew Point monitor connected to digital input
Limit	Limit or signal which causes reaction	Relative humidity is higher than threshold value (default value or dehumidifier trigger value)	Dew point is higher than threshold value (default value or dehumidifier trigger value)	Contact on external input opens (signal for condensation)	Temperature of ceiling surface is below dew point + 2K	Contact on digital input opens (signal for condensation)	Contact on digital input opens (signal for condensation)
	Reaction: Valves of circuits are closed (in cooling mode only)	-				 (all actuators of this Base)	 (actuators linked to this Mixed Circuit)
Reactions	Reaction: Dehumidifier is activated	 (dehumidifier linked to this zone)	 (dehumidifier linked to this zone)	 (dehumidifier linked to this zone)	-	 (all dehumidifier linked to this Base)	-
	Reaction: Stop mixed circuit which supplies this room	-	-	-	-	 (all Mixed Circuits linked to this Base)	 (Mixed Circuit linked to this U-Module)
	Other reaction	-	-	 Error displayed on Room Unit	-	ERROR message displayed in app	ERROR message displayed in app

Tab. 04-4 System response to humidity and dew point problems

Valid for:

 = cooling or

 heating, only when dehumidifier is active in heating mode

05 Component selection

05.01 Starting Point

The components of the NEA SMART 2.0 system allow a high degree of customization in regards of the requirements that can be found in the specific installation.

This flexibility allows – for example – the connection of a dehumidifier either to outputs of the Base, the R-Module or to a U-Module configured for this application.

The list below therefore does not show the exact and exclusive relationships.

The following information must be available to select the number and type of system components required:

- the number of rooms determines the number of Room units
- the number of heating circuits as well as the number of manifolds and their position in the building determines the number of actuators and the number of Bases and R-Modules
- the number of mixed circuits determines the number of U-Modules
- the number of dehumidifiers and fan coils as well as their position in the building determines the number of bases, R- and U-Modules
- the number of relay outputs required for pumps, heat generators, cooling generators and other devices determines the number of Bases and R-Modules
- the number of digital signals from other devices such as dew point monitors or heat pumps determines the number of Bases and R-Modules

If the NEA SMART 2.0 is part of a heating and cooling installation clarification is to be sought on which system (NEA SMART 2.0 or another system in the installation, e.g. BMS), will take the lead in deciding the overall operating mode (heating or cooling ...) of the installation. Both scenarios are possible but the required inputs/outputs may differ.

Inputs and/or outputs required for optional functions are:

Digital Outputs for

- Global and local pumps
- Heat/cool generator
- Switching valves, e.g. for heating or cooling
- Change over signal heating / cooling
- Control of dehumidifiers, fan coils
- Any other devices

Digital Inputs for:

- External input to switch the NEA SMART 2.0 installation to reduced mode or absent mode
- Dew point monitor to give signal when condensation takes place

- External change over signal heating / cooling
- Any other devices

05.02 Minimum and maximum configurations

NEA SMART 2.0 Base

- Max. 8 rooms
- Max. 12 actuators
- Max. 4 digital outputs
- Max. 4 digital inputs

The maximum number of possible thermal actuators connected to each of the 8 Room Zones (RZ) is limited and starting from Room Zone in ascending order is as follows: 2-2-1-1-2-2-1-1.

Every NEA SMART 2.0 Base can have a maximum of one NEA SMART 2.0 R-Module connected to it.

NEA SMART 2.0 R-Module

- Max. 4 rooms
- Max. 8 actuators (two per Room Zone)
- Max. 2 digital outputs
- Max. 1 digital inputs

A single NEA SMART 2.0 U-Module can control the following:

- Flow temperature / mixed circuit or
- Up to 2 dehumidifiers
- Up to 4 fan coils or
- Up to 2 fan coils and 2 dehumidifiers (but without valve control)

The minimum configuration of a NEA SMART 2.0 systems is:

- 1 NEA SMART 2.0 Transformer (if Base 24 V is used)
- 1 NEA SMART 2.0 Base
- 1 NEA SMART 2.0 Room unit
- 1 actuator

The maximum capacity of a NEA SMART 2.0 system (for 24 V) is:

- 5 NEA SMART 2.0 Bases
- 5 NEA SMART 2.0 R-Modules (but not more than the number of base)
- 9 NEA SMART 2.0 U-Modules

In the maximum configuration the NEA SMART 2.0 can control:

- 60 rooms
- 3 mixed circuits
- 9 dehumidifiers (5 dehumidifiers on the base units, 4 dehumidifiers on the U-Modules or the R-Modules)
- The maximum number of 5 U-Modules can be used even if there is one Base
- Up to 60 fan coils (if only fan coils are used)

05.03 Selection Process

05.03.01 Hydraulic Manifolds

Based on the number of rooms served and the associated pipe loops for each manifold, the NEA SMART 2.0 components can be selected using selection table 05-1.

Number of rooms (identical to Room units)	1 ... 8	9 ... 12
Number of pipe loops (identical to number of actuators)	1 ... 12	13 ... 20
	↓	↓
	NEA SMART 2.0 Base	NEA SMART 2.0 R-Module
	+	
	NEA SMART 2.0 Transformer	

Tab. 05-1 Selection matrix

Any room (unit) can be assigned to any number of heating circuits / actuators on one NEA SMART 2.0 Base or R-Module. That means that one NEA SMART 2.0 Room unit could be assigned to 20 heating circuits / actuators. However, in such a case the use of a zone valve, that controls the manifold as one, should be considered instead.

Sometimes there can be two hydraulic manifolds serving the same room. A meeting room in an office building may have an underfloor heating system as well as a chilled ceiling installed, each supplied by its own manifold. Placing the NEA SMART Base station next to the underfloor heating manifold and the R-module next to the one for the ceiling system would allow all the control of both systems with a single room unit.

Special attention is necessary, when within one room more than one system is installed and if the systems are used for heating and/or cooling. For example a room with

- underfloor heating only,
- wall heating and cooling
- ceiling cooling only.

In this case, only one Room unit is required, which is assigned to 3 channels of the Base or the R-Module (one channel for each system).

If a NEA SMART 2.0 R-Module is used for ceiling cooling, an additional NEA SMART 2.0 Transformer should be used for this.

The NEA SMART 2.0 Base and R-Module should be placed close to each hydraulic manifold because the actuators for each pipe loop have a limited cable length.

This setup is repeated for every manifold. As a result, the overall number of NEA SMART 2.0 Bases and R-Modules are defined.

05.03.02 Mixed circuits

NEA SMART 2.0 can control mixed circuits only for heating, cooling or heating and cooling. Every mixed circuit will need one NEA SMART 2.0 U-Module. The total number of three mixed circuits must not be exceeded.

The NEA SMART 2.0 U-Module should be placed close to the mixing valve to keep wiring to a minimum.

05.03.03 Dehumidifiers

There are the following ways to control dehumidifiers:

- via digital outputs of NEA SMART 2.0 Base or the R-Module (1 dehumidifier can be controlled per base or R-Module)
- via the digital outputs of a configured NEA SMART 2.0 U-Module (2 dehumidifiers, each with valve and compressor control can be controlled)
- via the digital outputs of a NEA SMART 2.0 U-Module configured for dehumidifier/fan coil (2 dehumidifier, 2 fan coils can be controlled, but only the compressor for the dehumidifiers)

The decision to use the NEA SMART 2.0 Base or the NEA SMART 2.0 U-Module depends on the following:

- Number of digital outputs available at the NEA SMART 2.0 Base. This is important to know because some digital outputs may be used for other functions, such as change over heating / cooling or boiler demand signal.
- Distance between the dehumidifiers and the NEA SMART 2.0 Base and necessary wiring

A maximum number of nine dehumidifiers must not be exceeded.

05.03.04 Fan Coils

Fan coils can be controlled:

- Via relay outputs of the base and the R-module
- Via a U-Module configured for fan coil (up to 4 fan coils)
- via the digital outputs of an U-Module configured for dehumidifier/fan coil (2 fan coils)
- via the room zone outputs (RZ) of a Base, in combination with a switching relay

05.03.05 Analog Inputs

Analog inputs can be used for the temperature sensors of the NEA SMART 2.0 system. The temperature sensors can be connected to the NEA SMART 2.0 Room units (additional input for remote sensor) and to the NEA SMART 2.0 U-Module if it is configured for a mixed circuit (flow, return and outside temperature sensors).

NEA SMART 2.0 Room Remote sensor

The NEA SMART 2.0 Remote sensor can be connected to any NEA SMART 2.0 Room unit and its function selected during system setup (according table 05-2).

Device	Possible Function
Remote sensor	Limiting floor temperature to a minimum and maximum value (lower limit valid for cooling, upper limit for heating). This function is useful, e.g. to protect wooden floors from overheating and to avoid that cooled surfaces are perceived as too cold.
	Same as above with additional option to maintain a minimum surface temperature. This can be used as a comfort function in bathrooms or similar.
	Remote room temperature probe (room temperature control only by this value). This function is useful if the NEA SMART 2.0 Room unit cannot be placed inside the room it has to control or if there is not enough space.
	Floor temperature control only . The room is solely controlled via the floor temperature.
	As an additional room temperature sensor (room temperature control using the mean value between the additional sensor and the sensor of the Room unit). This function can be used if the room temperature shall be controlled using the mean value of the temperature at two positions in the room. In order to avoid interference, the cable of the remote sensor may only be extended by a maximum of 10 m.

Tab. 05-2 Analog input Room unit

The input of the NEA SMART 2.0 Room unit can either be configured as analog (see table above) or digital (see next chapter) but not as both simultaneously.

NEA SMART 2.0 U-Module when used for mixed circuit control

Device	Function
Flow temperature sensor	Must always be installed for the control of the flow temperature
Return temperature sensor	Is recommended to optimize the flow temperature control
Outdoor temperature sensor	A wired external temperature sensor can be connected to the U-Module (instead of or in addition to the NEA SMART 2.0 wireless outdoor temperature sensors)

Tab. 05-3 Analog input U-Module

05.03.06 Digital Inputs

Digital Inputs can be used to receive information from other devices. Digital Inputs can be received either via the NEA SMART 2.0 Room unit, the NEA SMART 2.0 Base or the NEA SMART 2.0 R-Module.

NEA SMART 2.0 Room Unit

One of the functions described below can be defined during the setup of the system.

Device	Function
Window contact	A hard wired window contact can be used to avoid wasting energy with an open window: In the case of heating, the heating is interrupted and reduced after 30 minutes. In the case of cooling, the cooling of the room is stopped.
Dew point sensor	A dew point monitor detects condensation on pipes or surface and stops cooling in this room.

Tab. 05-4 Digital input room unit

The additional input of the NEA SMART 2.0 Room unit can either be configured as analog (chapter before) or digital (see table 05-4) but not as both simultaneously.

NEA SMART 2.0 Base and R-Module

A maximum of four digital inputs can be configured for one NEA SMART 2.0 Base.

One digital input can be configured for the NEA SMART 2.0 R-Module.

Within a NEA SMART 2.0 Base (and optional R-Module), a function can only be assigned once. That means, it is not possible to assign the same function to more than one input.

INPUT signal	Available on	Reaction
Dew point monitor	Room unit	Cooling of this room is stopped, associated dehumidifier is activated.
Note: Dew point monitor signal is triggered when the potential free switch is open	Base, R-Module	Cooling of all rooms assigned to the base and to connected R-Module is stopped, associated dehumidifiers are activated.
	U-Module (mixed circuit)	Mixed circuit is closed.
Window contact	Room unit	Heating / cooling is stopped for 30 minutes. After this, energy level of this room is switched to REDUCED.
Note: Window contact signal is active when the potential free switch is open	Base, R-Module	For all rooms assigned to the base and to connected R-module the same measures as described above apply.
HEATING	Base, R-Module	System is restricted to operating modes neutral or heating. The mode heating / cooling (automatic mode) may be activated, but cooling will not start as long as the input signal HEATING is active.
COOLING	Base, R-Module	System is restricted to operating modes neutral or cooling. Heating / cooling (automatic mode) may be activated, but heating will not start as long as the input signal COOLING is active.
Energy Level REDUCED LOCAL	Base, R-Module	All rooms ¹⁾ which are in TIMER mode go to energy level REDUCED.
Energy Level REDUCED GLOBAL	Base, R-Module	All rooms ¹⁾ which are in TIMER mode go to energy level REDUCED.
Energy Level ABSENCE	Base, R-Module	All rooms ²⁾ which are in TIMER mode go to energy level ABSENCE.

Tab. 05-5 Available digital input signals and system reaction

¹⁾ Applied to all rooms assigned to this Base and R-Module

²⁾ Applied to all rooms in the entire installation

NEA SMART 2.0 U-Module

If the U-Module is used for controlling a mixed circuit, then one digital input can be used to connect a dew point monitor.

Device	Function
Dew point monitor (when U-Module is used for mixed circuit control)	A dew point monitor detects condensation on pipes or similar. The mixed circuit is stopped, the cooling of all rooms that are supplied via this circuit is ended. Dehumidifiers belonging to these rooms are activated.

Tab. 05-6 Digital input U-Module

05.03.07 Digital Outputs

Digital Outputs can be used to control other devices such as pumps or boiler. Digital Outputs can be used on the NEA SMART 2.0 Base, NEA SMART 2.0 R-Module and NEA SMART 2.0 U-Module.

NEA SMART 2.0 Base and R-Module

A maximum of four digital outputs can be configured on a single NEA SMART 2.0 Base.

Two outputs can be configured for the NEA SMART 2.0 R-Module.

Within a NEA SMART 2.0 Base (and optional R-Module), a function can only be assigned once. That means, it is not possible to assign the same function to more than one output.

OUTPUT signal	Available on	Trigger
Pump local	Base, R-Module	A room assigned to this base or a connected R-module has a current demand signal (heating or cooling) or a dehumidifier allocated to the base or connected R-Module triggers the "hydraulic" valve (only in cooling mode).
Pump global	Base, R-Module	Any room of the entire installation has a current demand signal (heating or cooling) or any of the dehumidifier triggers the "hydraulic" valve (only in cooling mode).
Pump mixed circuit	U-Module (configured for mixed circuit)	Demand signal for mixed circuit has been generated.
Boiler	Base, R-Module	A room of the entire installation not supplied via a mixed circuit triggers a heating demand signal or any of the mixed circuits causes the mixing valve to open by more than the pre-defined amount/level.
Chiller	Base, R-Module	Same as above, but for cooling demand signal.
HEATING	Base, R-Module	System is in heating mode. Can be used to control the operation mode „heating" to other devives or to a BMS.
COOLING	Base, R-Module	Same as above, but for cooling.
Valve dehumidifier	Base, R-Module, U-Module	Dehumidification sequence started. Valve opens before compressor starts.
Compressor dehumidifier	Base, R-Module, U-Module	Dehumidification started.
Alarm	Base, R-Module	Error signal.
Fan Coil	Base, R-Module, U-Module	Fan Coil operation has been requested.
Fan Coil Pump	Base, R-Module, U-Module	Fan Coil operation has been requested.

Tab. 05-7 Available digital output signals and the condition to activate them

NEA SMART 2.0 U-Module

Device	Function
Heating circuit pump (if the U-Module has been configured for mixed circuit)	The heating circuit pump is started as required
Dehumidifier valve (if the U-Module has been configured to control dehumidifiers)	The hydraulic valve, which is used to supply the dehumidifier, is switched on before the dehumidifier is activated
Compressor dehumidifier (if the U-Module has been configured for dehumidifiers or for combination dehumidifier/fan coil)	The compressor of the dehumidifier is started
Fan Coil (if the U-Module has been configured to control fan coils or for combination dehumidifier/fan coil)	The fan coil starts

Tab. 05-8 Digital output U-Module

05.04 Internet Connection

Although an internet connection is not required to run the NEA SMART 2.0 system, a connection is recommended to benefit from the following advantages:

- full control of the system even when not at home
- latest software version via over-the-air-updates (OTA) available
- have access to detailed evaluations of temperatures, humidity, flow temperature reports, ...
- Advanced functions such as geofencing are possible

The connection to the internet can be done

- Via WIFI network (2,4 GHz)
- Via Ethernet cable.

The recommended option is via cable as WIFI may not be available at the place of installation, e.g. basement.



The manual assignment of IP address and respective subnet is not supported on device itself, however, NEA acts as an DHCP client. Therefore NEA can be used only within the Networks with running instance of DHCP server.

In more complex installations with more than one NEA SMART 2.0 Bases, only the master base station requires an internet connection.

05.05 Wiring

Basics

The NEA SMART 2.0 communication architecture consists of two separate BUS systems.

The Zone Bus (ZOBUS) connects the components

- NEA SMART 2.0 Base
- NEA SMART 2.0 R-Module
- the bus Room units belonging to this Base or R-Module

- Characteristics of the Zone Bus:

- only a 2-wire line required
- reverse polarity-proof
- any topology possible
- no bus cable required, existing lines can usually be used

Maximum length is 100 m in case J-Y(ST)Y 2 x 2 x 0.8 mm is used. Maximum length may differ if other cable types are used.

The System Bus (SYSBUS) connects the NEA SMART 2.0 Bases and the NEA SMART 2.0 U-Modules. The following rules must be considered:

- Must be installed in series
- Requires shielded twisted pair line (NEA SMART 2.0 Bus cable, J-Y(ST)Y 2 x 2 x 0.8 mm).
- The maximum length between a Base and an U-Module is 100 m, the maximum total length is 500 m.

The use of existing wires is possible, but certain rules need to be followed.

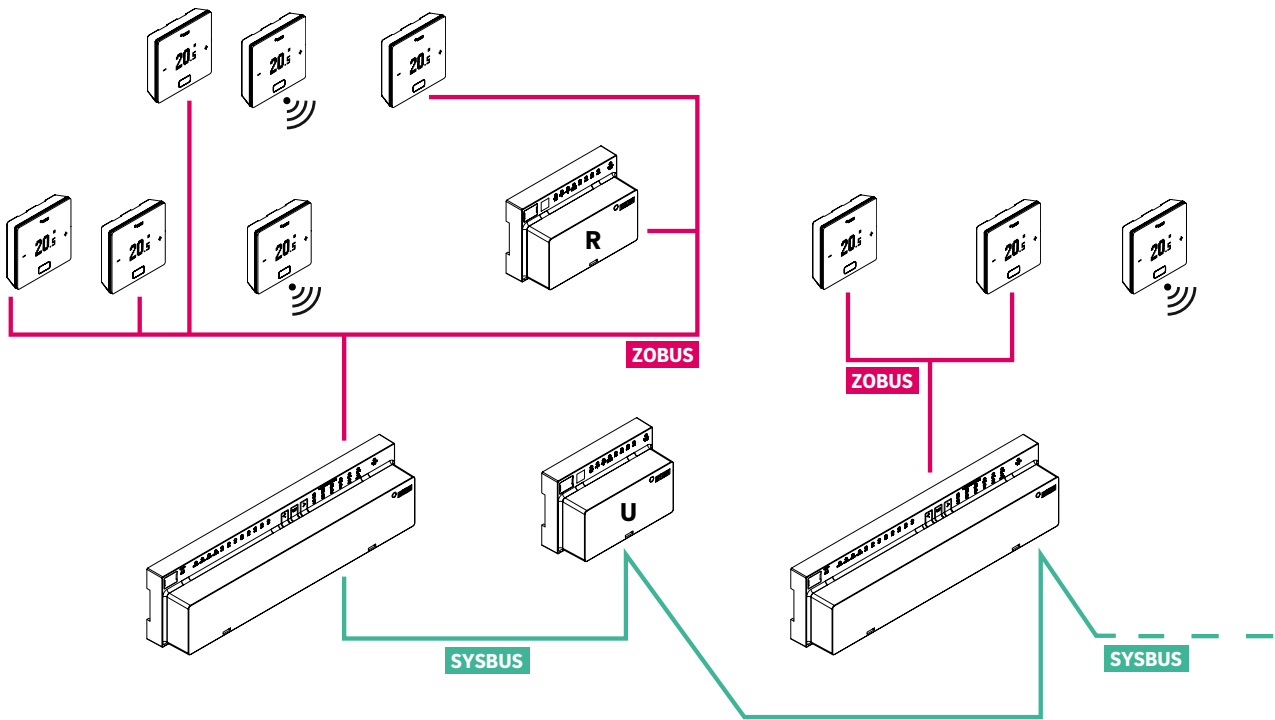

Fig. 05-1 Zone Bus and System Bus

Connection between Unit 1	Unit 2	Communication system	Cable type recommended / alternative	Topology / maximum length
Base	Room unit Bus	ZOBUS Zone Bus	NEA SMART 2.0 Bus cable/ alle 0,8 mit Punkt 0.8 mm / existing 2-wire line	Any / 100m
Room unit Bus	Room unit Bus	ZOBUS Zone Bus	NEA SMART 2.0 Bus cable/ J-Y(ST)Y 2 x 2 x 0.8 mm / existing 2-wire line	Any / 100m
Base	R-Module	ZOBUS Zone Bus	NEA SMART 2.0 Bus cable/ J-Y(ST)Y 2 x 2 x 0.8 mm / existing 2-wire line	Any / 100m
Base	Base	SYSBUS System Bus	NEA SMART 2.0 Bus cable/ J-Y(ST)Y 2 x 2 x 0.8 mm	Line / 500m
Base	U-Module	SYSBUS System Bus	NEA SMART 2.0 Bus cable/ J-Y(ST)Y 2 x 2 x 0.8 mm	Line / 100m

Tab. 05-9 Recommended cable types



The polarity of System Bus (SYSBUS) has to be strictly observed. A swapping of polarity causes damages at the base units and/or U-Modules!

If the existing wiring of previously installed Room units is used for the Zone Bus, strict care must be taken to ensure that the existing lines are consistently disconnected from the mains.

It is not permitted to run in the Zone Bus line simultaneously 230 V or 24 V supply voltage.

The country-specific standards and regulations must always be observed!

05.06 Application Examples

General Remarks:

The following chapters show typical applications for 24 V installations. They are meant to give a general overview of the system structure. More detailed design can be found in the chapter "Schemes".

05.06.01 Heating system with mix of wireless and wired Room units (up to eight rooms)

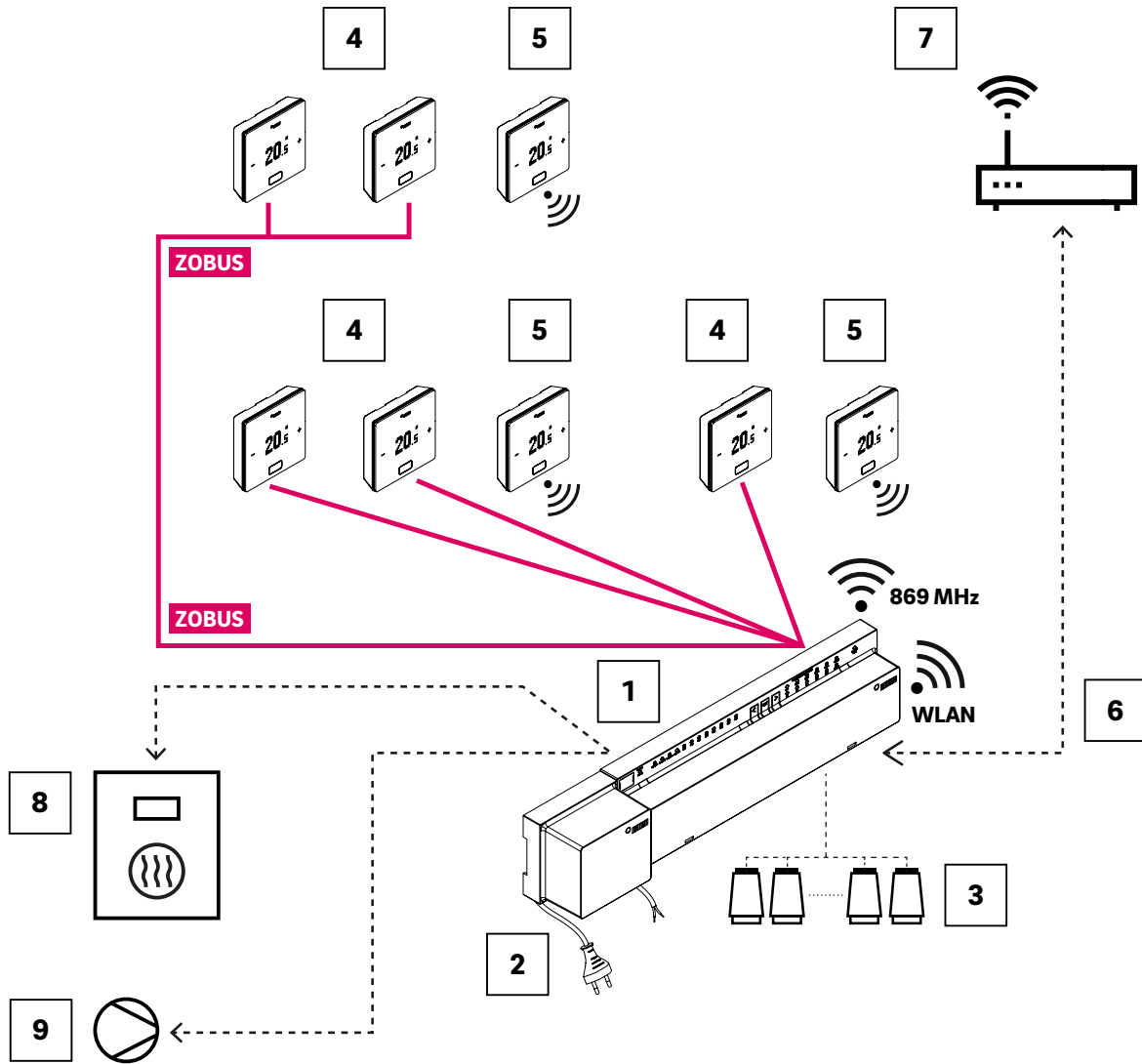

Fig. 05-2 NEA SMART 2.0 system, room control for heating

ZOBUS	Zone bus to connect the Room unit	[5]	NEA SMART 2.0 Room unit, wireless
[1]	NEA SMART 2.0 Base 24 V, central control unit (master); for up to eight rooms	[6]	WLAN/LAN interface to connect the system to router and cloud
[2]	NEA SMART 2.0 Transformer 24 V	[7]	Router for WLAN/LAN home network and connection to cloud
[3]	Actuators 24 V on manifold	[8]	Output signal from the Base to heat generators
[4]	NEA SMART 2.0 Room unit, wired	[9]	Output signal from the Base to pump

Tab. 05-10 Heating system with mix of Room units up to 8 rooms

05.06.02 Heating and Cooling system with mix of wireless and wired Room units and R-Module (up to twelve rooms)

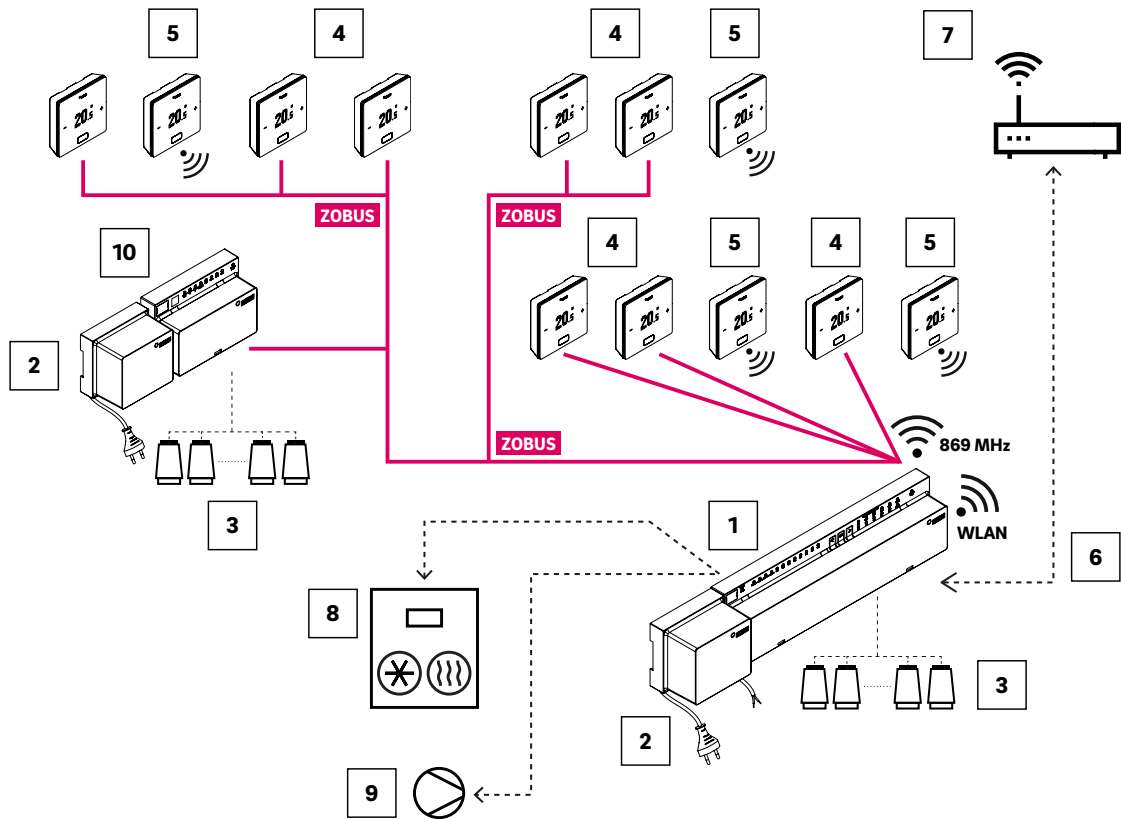

Fig. 05-3 NEA SMART 2.0 system, room control for heating/cooling for up to 12 rooms

ZOBUS	Zone bus to connect the Room units and R-Module	[6]	WLAN/LAN interface to connect the system to router and cloud
[1]	NEA SMART 2.0 Base 24 V, central control unit (master); for up to eight rooms	[7]	Router for WLAN/LAN home network and connection to cloud
[2]	NEA SMART 2.0 Transformer 24 V	[8]	Output signal from the Base to heat / cold generators
[3]	Actuators 24 V on manifold	[9]	Output signal from the Base to pump
[4]	NEA SMART 2.0 Room unit, wired	[10]	NEA SMART 2.0 R-Module 24 V, R-Module for four additional rooms
[5]	NEA SMART 2.0 Room unit wireless, to measure the room temperature and room air humidity		

Tab. 05-11 Heating and Cooling system with mix of Room units and R-Module up to 12 rooms

05.06.03 Heating and Cooling system with mix of wireless and wired Room units and slaves (up to twenty four rooms)

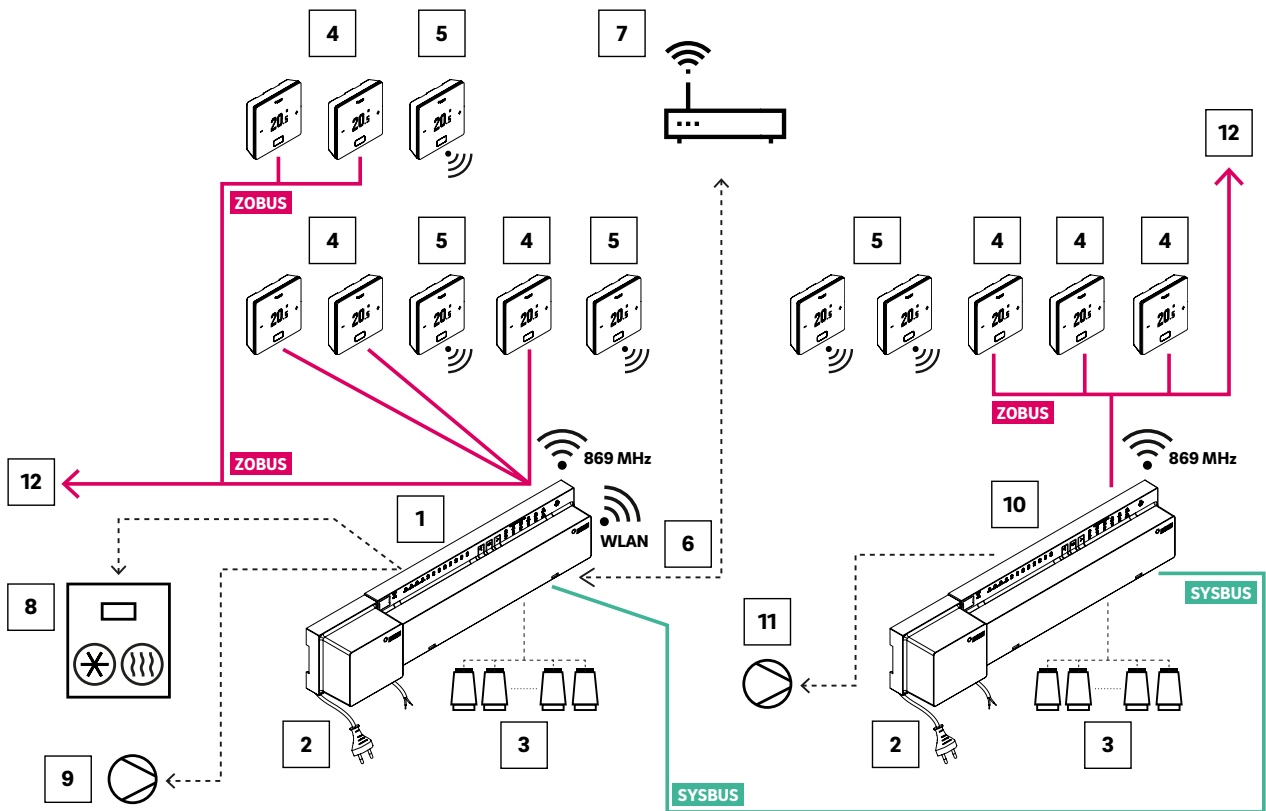

Fig. 05-4 NEA SMART 2.0 system, room control for heating/cooling for up to 24 rooms

ZOBUS Zone bus to connect the Room units	[6] WLAN/LAN interface to connect the system to router and cloud
SYSBUS System bus to connect slave units or U-Modules	[7] Router for WLAN/LAN home network and connection to cloud
[1] NEA SMART 2.0 Base 24 V, central control unit (master); for up to eight rooms	[8] Output signal from the Base to heat / cold generators
[2] NEA SMART 2.0 Transformer 24 V	[9] Output signal from the Base to (global) pump
[3] Actuators 24 V on manifold	[10] NEA SMART 2.0 Base 24 V, central control unit (slave); for up to eight rooms
[4] NEA SMART 2.0 Room unit wired, to measure the room temperature and room air humidity	[11] Output signal from the Base (slave) to local pump
[5] NEA SMART 2.0 Room unit wireless, to measure the room temperature and room air humidity	[12] Continuation of the ZOBUS to more room units or NEA SMART 2.0 R-Module

Tab. 05-12 Heating and Cooling system with mix of Room units and slaves up to twenty four rooms

05.06.04 Heating and Cooling system with mix of wireless and wired Room units and U-Module (for mixed circuit)

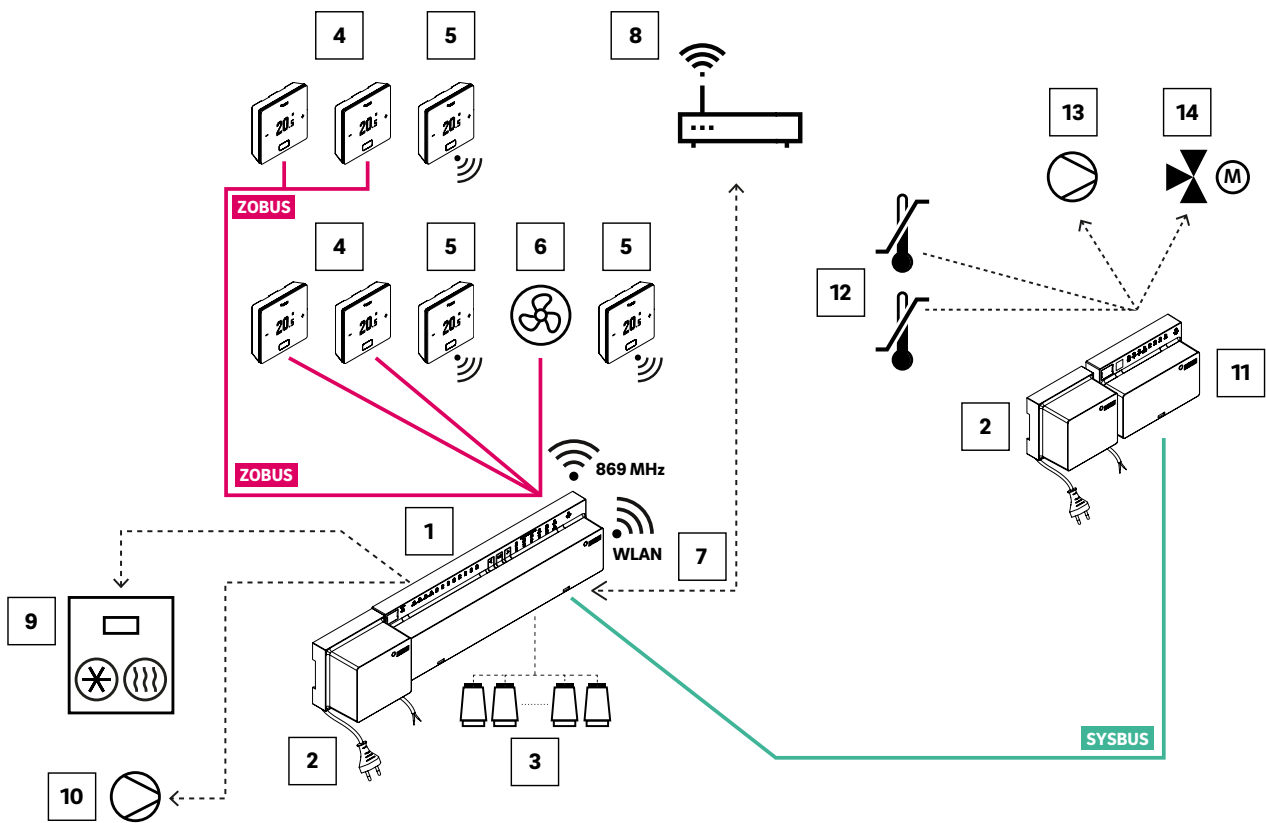

Fig. 05-5 NEA SMART 2.0 system, room control for heating/cooling with control for a mixed circuit

ZOBUS Zone bus to connect the Room units	[7] WLAN/LAN interface to connect the system to router and cloud
SYSBUS System bus to connect slave units or U-Modules	[8] Router for WLAN/LAN home network and connection to cloud
[1] NEA SMART 2.0 Base 24 V, central control unit (master); for up to eight rooms	[9] Output signal from the Base to heat / cold generators
[2] NEA SMART 2.0 Transformer 24 V	[10] Output signal from the Base to (global) pump
[3] Actuators 24 V on manifold	[11] NEA SMART 2.0 U-Module for mixed circuit
[4] NEA SMART 2.0 Room unit wired, to measure the room temperature and room air humidity	[12] VL/RL sensor, temperature sensor to measure flow and return temperature
[5] NEA SMART 2.0 Room unit wireless, to measure the room temperature and room air humidity	[13] Pump for mixed heating circuit
[6] Fan coil, assigned to a room as an additional system, controlled via the relay output of the NEA SMART 2.0 Base or via NEA SMART 2.0 Switching relays, connected to the triac output	[14] 3-way mixing valve with 0 ... 10 V actuator (24 VAC, 0 ... 10 V actuation)

Tab. 05-13 Heating and Cooling system with mix of Room units and U-Module for mixed circuit

06 Installation

06.01 Leaflets

The installation of the individual components is described in the leaflets that come with the devices.

All leaflets can also be found at
www.rehau.com/neasmart2

07 System set up

After installation of all components, finalization and accurate check of system wiring the set up may start.

07.01 General remarks to set up procedure

07.01.01 Preparation

Before set up is started, it is necessary to have all schemes and tables ready to hand, which describe all connections and relations in the installation, that has to be set up, e.g. hydraulic schemes.

07.01.02 Different complexity of systems (class A, B, C)

In terms of complexity and functionality, 3 classes of NEA SMART 2.0 system can be differed:

Class A – room temperature control heating only (1 Base)

Simple system with one NEA SMART 2.0 Base only, optional with R-Module. Used for room temperature control in heating mode only.

Class B – room temperature control heating and cooling (1 Base)

Simple system with one NEA SMART 2.0 Base only, optional with R-Module, for room temperature control in heating and cooling mode.

Class C – system with more functions

System with one or more additional system bus components (Bases or U-Modules) with full functionality.

It is possible to drive devices such as pumps, heat/cold generator and others in all classes.

It is possible, to set up a system of class A without connecting a smart phone or tablet to the Base and using the Wizard. But it is strictly recommended to do this, because this is the most easiest way to check the configuration and to allow essential functions like timed mode.

07.01.03 Flow chart of set up procedure

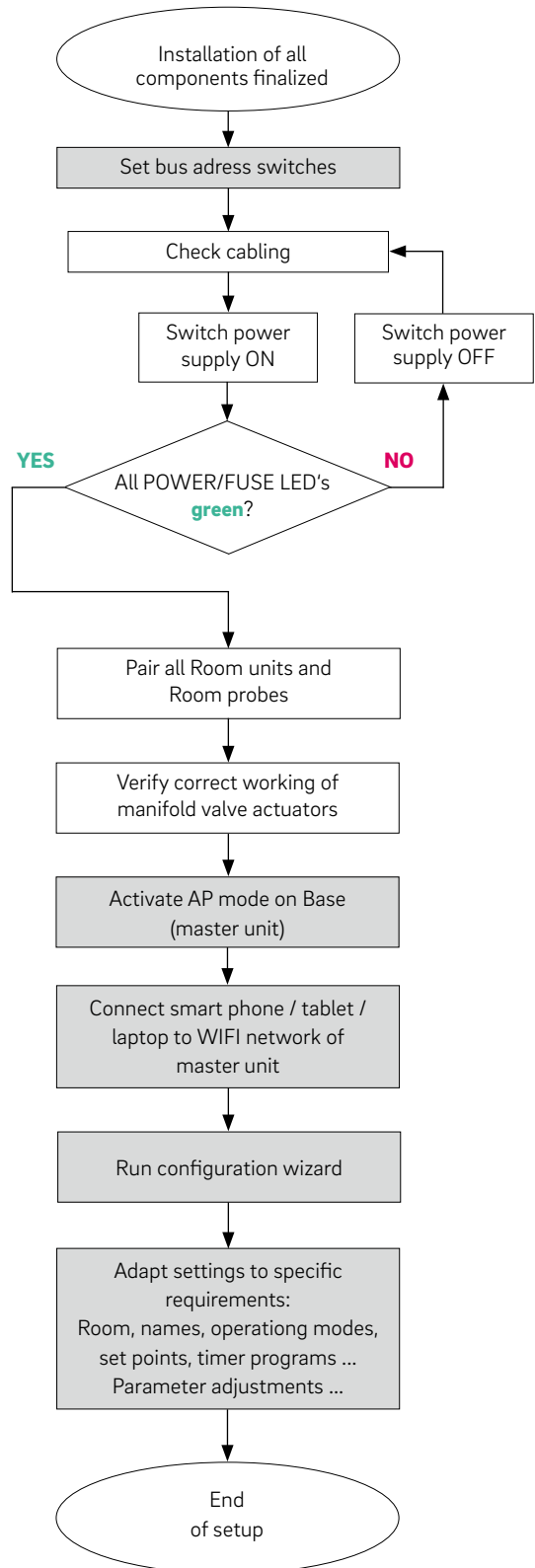

Fig. 07-1 Set up procedure

07.02 Set system bus addresses

The following components are using the system bus to communicate:

- NEA SMART 2.0 Base units (one Master and up to 4 Slaves)
- NEA SMART 2.0 U-Module (up to 9 modules)

Each of these devices needs an individual address. Double addresses block the bus communication.

Note:

The NEA SMART 2.0 Base with address setting "0" is the master of the system. Only the master is communicating via WLAN or LAN to router or to a tablet / smartphone / laptop.

Address settings for NEA SMART 2.0 Base (DIP switches are below the front cover):

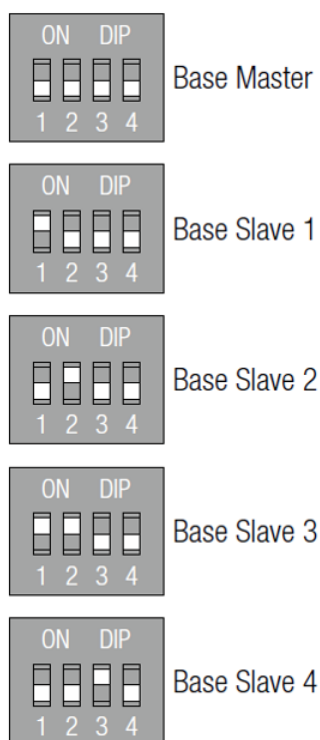

Fig. 07-2 DIP switches on Base



The address setting of the NEA SMART U-Modules starts with the 1st module with address "0" (all dip-switches set to 0, see below). The address setting of the U-Modules is not in conflict with the addresses of the NEA SMART 2.0 Base units, even when the DIP switches have the same position.

Für NEA SMART 2.0 U-Module:

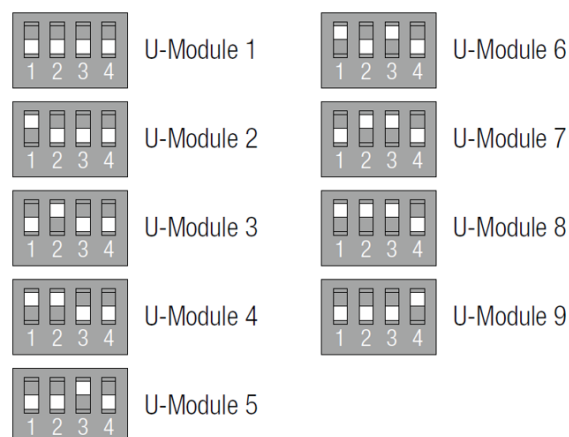

Fig. 07-3 DIP switches on U-Module

07.03 Switch on power supply



Before you switch on the power supply, check again the wiring. Especially take care, that the wires of the system bus cable (SYSBUS) are correctly connected.

GND, VDC, 1 and 2 must be connected with the same terminals on the other units, otherwise the devices will be damaged!



07.03.01 Check POWER / FUSE LED's

After switching on the power supply, check the POWER/FUSE LED's of all components!
The table below provides troubleshooting tips.



If one of the LED's does not show, what has been expected, please:

- switch off power supply
- check and correct cabling
- replace defective fuses (only use correct fuse types!)
- switch power supply on

NEA SMART 2.0 device	LED green 	LED red 	LED off 
Base	Power supply OK	Power supply is connected, fuse is defective Check wiring of Base	No power supply connected Check power supply connection
R-Module	Power supply from Zone Bus is OK, Additional power supply for actuators is connected	Power supply from Zone Bus is OK, Additional power supply for actuators is not connected Connect power supply for actuators	No power supply from Zone Bus Check Zone Bus connection
U-Module for mixed circuit	VDC power supply from system bus cable is OK, Additional power supply for mixing valve actuator is connected	VDC power supply from system bus cable is OK, Additional power supply for mixing valve actuator is not connected Connect power supply for actuator	VDC power supply from system bus cable is not present. Check system bus cable connection
U-Module for dehumidifier	VDC power supply from system bus cable is OK, Additional power supply which is not needed, is connected Check additional power supply	VDC power supply from system bus cable is OK, Additional power supply which is not connected (and not needed)	VDC power supply from system bus cable is not present. Check system bus cable connection

Tab. 07-1 LED's on devices

07.03.02 Check zone bus LED's

The zone bus LED of the NEA SMART 2.0 Base is blinking, when there is a zone bus component (NEA SMART 2.0 R-Module or bus-based room unit) connected.

07.03.03 Check manifold actuators

For the first 5 times, the NEA SMART 2.0 Base is switched on, the outputs of the channels, where the manifold actuators are connected, are switched on one after the other for about 10 minutes.

This is done to open the actuators completely and to unlock the "first open function" of the actuators.

During this time span, the correct operating of all actuators can be checked.

Note:

This function can be stopped by pressing the OK button.

During this time span, all other outputs of the NEA SMART 2.0 Base are blocked.

07.04 Pairing

07.04.01 General notes

Pairing is the logical connection of a room unit, a room probe or an outdoor temperature sensor to one or more channels of the NEA SMART 2.0 Base.

Note:

It is possible, to pair a device to one or more channels, but it is not possible, to pair more than one device to one channel of the NEA SMART 2.0 Base.

Each new paired device deletes the previous pairing of another device, if it is done on the same channel.

07.04.02 Start pairing procedure on Base

Start pairing procedure:

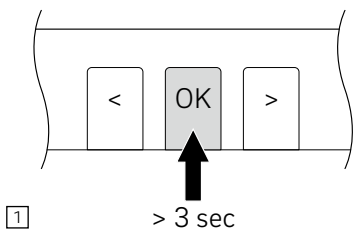

1 Press OK for > 3 seconds

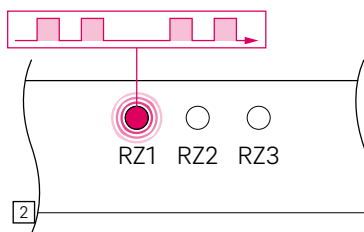

2 The LED of the first zone, which is ready for pairing, is blinking fast

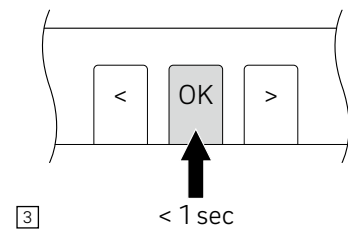

3 Select the zone(s) for pairing: onfirm this zone by pressing OK short

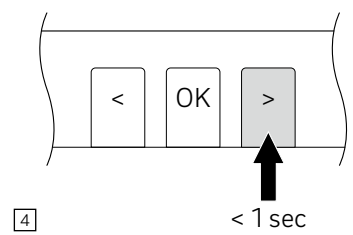

4 or move to another zone by using the keys "<" or ">"

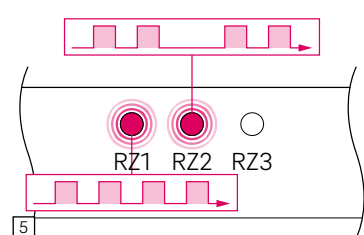

5 Confirm all zones you want to pair to one room unit by pressing OK short

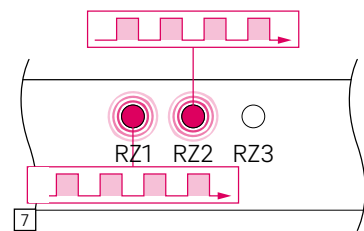
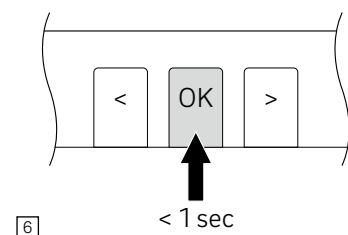

7 All selected zones are blinking continuously

Now you can pair the room unit. The NEA SMART 2.0 Base stays in the pairing mode for 3 minutes.

07.04.03 Pairing of NEA SMART 2.0 Room Units



The below listed pairing functions are only available in the first 48 hours after the room unit / room probe is powered. This 48 hour time span starts again if the room unit/ room probe gets unpowered and repowered again. See chapter 07.04.06 for details.

For wireless room units (with display):

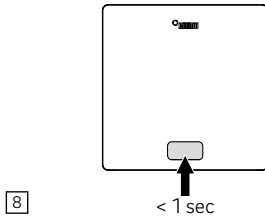

- Insert the batteries
- Close cover
- Press Home button

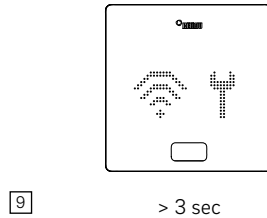

The room unit shows first the start up sequence and then the radio waves and a tool symbol

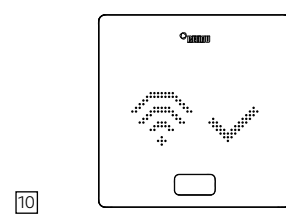

After successful pairing, the display shows as a confirmation a hook and then the numbers of the paired channels are shown

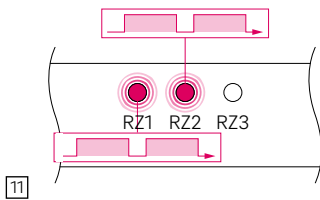

On the NEA SMART 2.0 Base, blinking of the paired channels changes to a slower blinking

For pairing the next units, move with the < and > keys to the next channel you want to pair and perform the steps describe above.

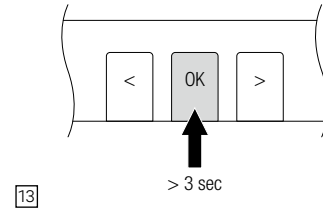

To leave the pairing mode, press OK button of the NEA SMART 2.0 Base again for 3 secs

When pairing failed, the display shows the radio wave symbol and an exclamation mark.

In this case:

- Verify, that the Base was still in pairing mode
- Check whether the distance between room unit and NEA SMART 2.0 Base is not too big or
- Whether there are shielding elements between room unit and base which avoid communication.

In this case whether another place for the room unit can be used.

Note:

If the batteries have been already inserted for a longer time, press OK for about 3 seconds to start the pairing process.

For wired room units (with display):

Press OK for less than a second to start the pairing process.

The reaction of the wired room unit is exactly the same as for wireless room units.

07.04.04 Pairing of NEA SMART 2.0 Room probes

The Room probes have no display or key on the front side, only a red LED in the middle of front plate.

Pairing is done by using a screw driver and pressing an internal button on the right bottom side. Waiting for pairing is displayed by blinking shortly twice, and a 1-sec pause.

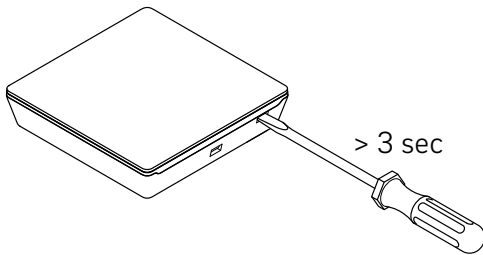

Fig. 07-4 Pairing procedure on Room probes

Pairing is confirmed by blinking slowly 2 times. Pairing failure is 3 times blinking fast and a 1-sec pause.

07.04.05 Pairing of NEA SMART 2.0 outdoor sensor

Note:

The wireless outdoor sensor is paired to any channel of the NEA SMART 2.0 Base, no matter whether this channel is used already or not.

- Open the cover of the sensor
- remove the isolation stripe of the battery
- press the small button for 3 seconds

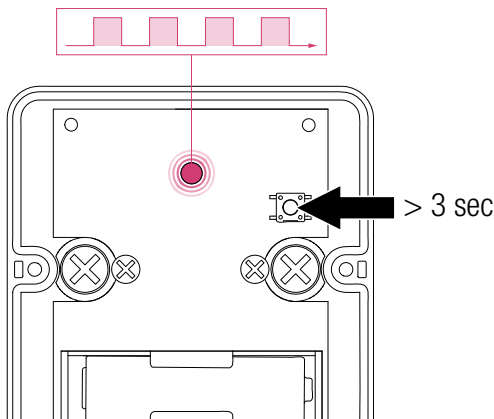

Fig. 07-5 Pairing outdoor sensor



Successful pairing is signaled on the NEA SMART 2.0 Base by simultaneous flashing of all channel LEDs.

07.04.06 Further settings on NEA SMART 2.0 Room units

Remark:

The below listed menu points are only available in the first 48 hours after pairing the room unit.

If you want to use these features after this time span:

- Open front plate
- For wireless room units: remove one of the batteries
- Press home button several times
- For wireless room units: insert the batteries
- Close front plate

- 1 Press OK

After this procedure, the room unit shows:

- 2 Start up sequence
- 3 Connected channels
- 4 Room temperature value

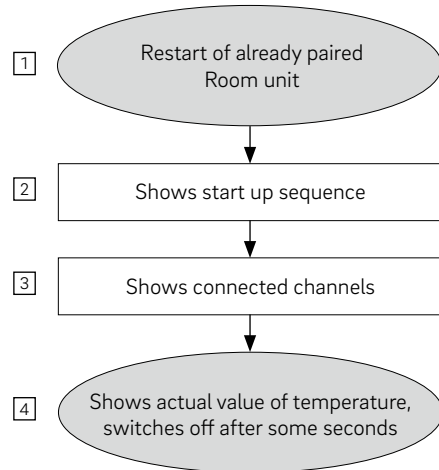

Fig. 07-6 Settings Nea Smart 2.0 Room units

If you have an already paired room unit (not longer than 48 hours ago or prepared as described in last paragraph), you can use some features shown in the flow chart below.

- 1 By pressing OK long you jump to
- 2 Installer level

To show the already paired channels, press minus symbol 3.

To start pairing sequence again (NEA SMART 2.0 Base must be in pairing mode), press plus symbol 4.

By pressing OK, the next screen appears. You leave this mode by double clicking OK (or wait some time).

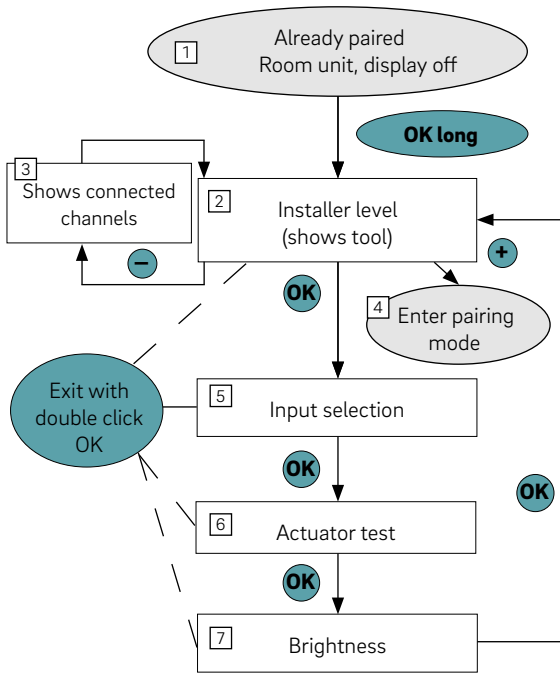

Fig. 07-7 Settings Nea Smart 2.0 Room units

5 Input selection

The probe or contact connected to the additional input of the room units can be defined here (or later in the configuration wizard).

The parameters are:

- 0: Not used
- 1: Floor temperature probe for minimum and maximum value monitoring (minimum value valid for cooling, maximum value for heating)
- 2: Floor temperature probe for minimum and maximum value monitoring (minimum value valid for cooling and heating, maximum value for heating)
- 3: External room temperature probe (room temperature control only by this value)
- 4: External floor temperature probe (floor temperature control)
- 5: External room temperature probe (room temperature control by mean value of external and internal probe)
- 6: Dew point sensor (closed when there is no condensation)
- 7: Window contact (closed when window is closed)
- 8: Temperature sensor for cooled surfaces or pipes (stops cooling when dew point temperature is reached)

6 Actuator test

The actuators of all channels which are paired to this room unit can be switched ON or OFF. This state remains for 30 minutes.

7 Display brightness view and adapt

The brightness of the display may be set to 20 % (default value), 40 %, 60 %, 80 % or 99 %.

07.05 Configuration - Wizard

07.05.02 Preparation

07.05.01 Introduction

The Configuration Wizard is a tool for setting up a system for simple applications such as room temperature control for heating only up to complex installations with multiple NEA SMART 2.0 Bases, including mixed circuits, dehumidification and fan coils. The wizard guides you through the various steps of the configuration and ensures that all components required in the system are configured. To use the wizard, a smartphone, a tablet or a laptop with internet browser is required.

The NEA SMART 2.0 Base has an integrated WLAN/LAN (WiFi) module. To use the configuration wizard, you have to connect your device (smart phone, tablet, ...) in AP mode to the NEA SMART 2.0 Base.

Remark:

LAN and WLAN are working in cloud mode (to access to cloud server) or in Access Point mode (AP mode). In AP mode only 1 device can be connected. In delivery state, WiFi/LAN of NEA SMART 2.0 Base is switched off.

Follow these steps:

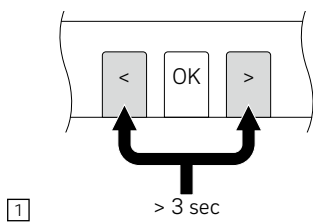

1 Activate WiFi/LAN functionality by simultaneously pressing < and > for 3 secs

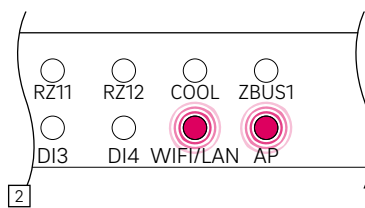

2 LEDs WiFi/LAN and AP are blinking simultaneously

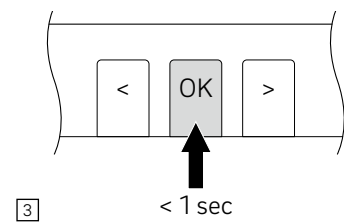

3 Confirm by pressing OK

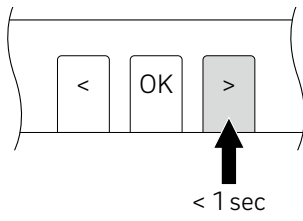

4 Change operating mode by pressing > to AP mode: WiFi/LAN LED is blinking, AP LED is ON. You can change between the different modes by pressing > or <

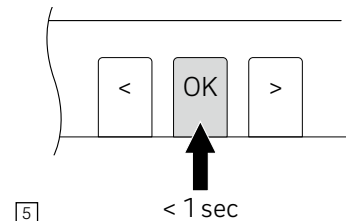

5 Confirm WiFi/LAN AP mode by pressing OK

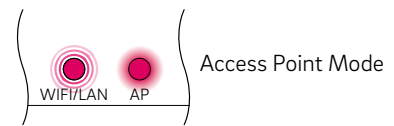

6 WiFi/LAN LED is blinking, AP LED is ON

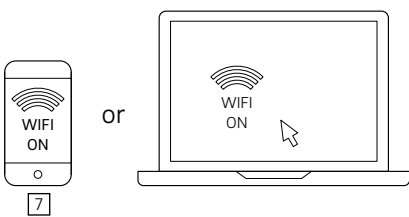

7 Prepare your device: Go to settings, then to WiFi/WLAN settings

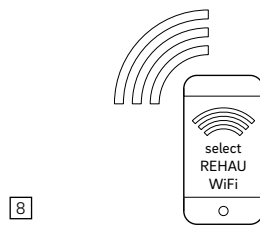

8 Select the network NEASmart2-XX...XXX

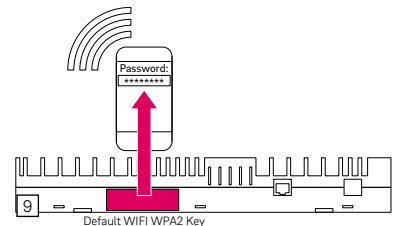

9 Insert WPA2 key. The default key is shown on the label of the base and on the sticker that can be found on the front page of the instruction manual. After connection the WiFi/LAN LED is continuously ON.

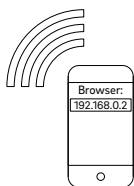

10 Start your browser and enter in the web address line the IP address 192.168.0.2

Follow instructions in browser. For activating cloud-access installation: enter WiFi SSID and password for your home WiFi in the browser setup.

11

07.05.03 Example for configuration

The following configuration sequence is based on an installation with

- 1 NEA SMART 2.0 Base
- 1 NEA SMART 2.0 R-Module
- 2 NEA SMART 2.0 U-Modules

Characteristics:

- There are 4 rooms: 2 of them have underfloor heating and ceiling cooling, the other 2 only under floor heating.

- The 2 rooms which are cooled have each one a dehumidifier
- 1 mixed circuit supplies one manifold for underfloor heating and one manifold for ceiling cooling
- Actuators installed on the manifold for underfloor heating are connected to NEA SMART 2.0 Base
- Actuators installed on the manifold for ceiling cooling are connected to NEA SMART 2.0 R-Module, which is installed directly beside the manifold

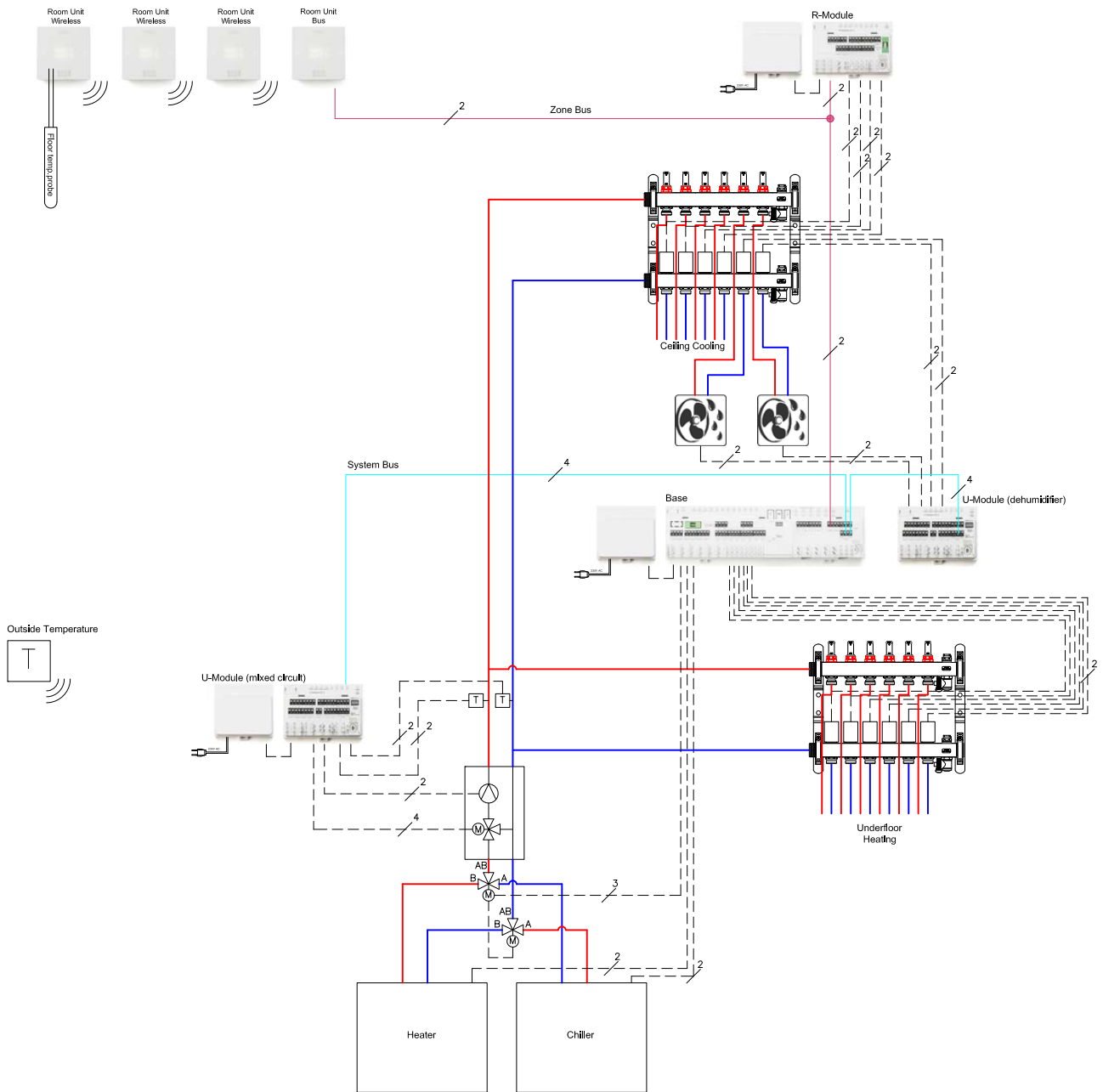

Fig. 07-8 Scheme for example configuration

07.05.04 General settings

The wizard automatically starts once your browser opens the page 192.168.0.2.

Please follow the instructions in the browser and avoid going back and forward.

On first screen you may set:

- Your language
- Building type (residential or commercial): This selects the appropriate daily programs for weekly program#1 for the room temperature set points.
- Building type standard or low energy: This selects appropriate setting for the heat curves (details can be found in chapter 9 Parameters)
- Date of installation and system date and time are taken from the device which is used for configuration

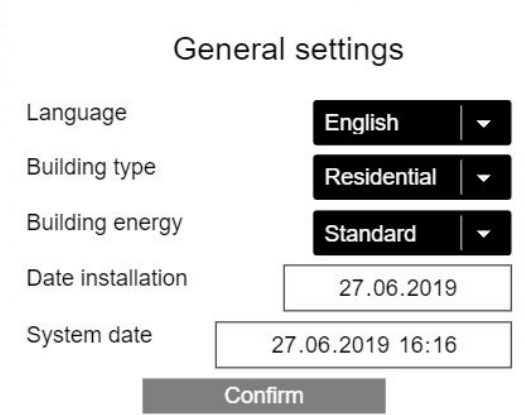

Fig. 07-9 Webpage: General settings

07.05.05 Choose system type

Before continuing, please ensure that the conditions listed on this page are fulfilled.

- Simple installations have only 1 NEA SMART Base 2.0, optionally with one NEA SMART 2.0 R-Module
- Installation with at least 1 system bus component (U-Module or another Base) are complex installations

If you choose simple installation, the wizard continues at point 7.5.14.

Before continuing with the installation, please check the following :

- All DIP switches are set and checked
- All electrical connections are done and checked
- System bus connections are done and checked
- All central controllers and extension modules are powered
- Outside temperature probes are connected/paired
- All room units are paired

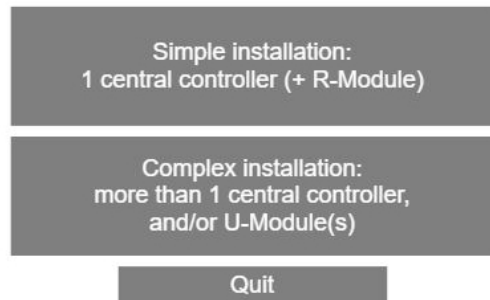

Fig. 07-10 Webpage: Choose system type

07.05.06 Enter system components and functions

The inputs on this page are used to check in terms of

- what will be found, when the components of the system are scanned later
- what you define during the wizard run

Number of external sensors

In case that more than one external sensor is used, an average value is calculated.

Outside temperature from the server used:

Instead of a wireless or wired external sensor (local sensor), this information can be transferred from the server. If there are additional local probes, an average value of the local probes is calculated and an average value is formed from this value and the value inherited from the server.

Please note:

To use this, the system has to be online and the address of the installation has to be set in the NEA SMART 2.0 App.

◀ **System components**

No. Base units (Master+Slave)	<input type="text" value="1"/>
No. R-Modules	<input type="text" value="1"/>
No. Rooms	<input type="text" value="4"/>
No. U-Modules	<input type="text" value="2"/>
No. Mixed circuits	<input type="text" value="0"/>
No of pumps (local/global only!)	<input type="text" value="0"/>
Boiler demand signal	<input checked="" type="checkbox"/>
Chiller demand signal	<input checked="" type="checkbox"/>
No. Dehumidifiers	<input type="text" value="0"/>
No. fancoils	<input type="text" value="0"/>
No. Outside sensors	<input type="text" value="0"/>
Outside temperature from server used (system has to be online)	<input type="checkbox"/>
No. Manifolds	<input type="text" value="2"/>

Confirm

Quit

Fig. 07-11 Webpage: System components

If you choose a system configuration which is not possible, you will get an error message:

◀ **System components**

Too much rooms

No. Base units (Master+Slave)	<input type="text" value="1"/>
No. R-Modules	<input type="text" value="1"/>
No. Rooms	<input type="text" value="15"/>

Fig. 07-12 Webpage: Too many rooms

Maximum number of rooms is 12, because one Base works with 8 rooms and the R-Module works with additional 4 rooms.

◀ **System components**

Configuration not possible

No. Base units (Master+Slave)	<input type="text" value="1"/>
No. R-Modules	<input type="text" value="1"/>
No. Rooms	<input type="text" value="4"/>
No. U-Modules	<input type="text" value="1"/>
No. Mixed circuits	<input type="text" value="1"/>
No of pumps (local/global only!)	<input type="text" value="1"/>
Boiler demand signal	<input checked="" type="checkbox"/>
Chiller demand signal	<input checked="" type="checkbox"/>
No. Dehumidifiers	<input type="text" value="2"/>
No. Fancoils	<input type="text" value="1"/>
No. Outside sensors	<input type="text" value="1"/>
Outside temperature from server used (system has to be online)	<input type="checkbox"/>
No. Manifolds	<input type="text" value="2"/>

Confirm

Quit

Fig. 07-13 Webpage: Configuration not possible

For 1 mixed circuit and 2 dehumidifiers, there are 2 U-Modules needed!

07.05.07 System bus scan

The system bus scan checks all system bus members which components are connected to the system bus:

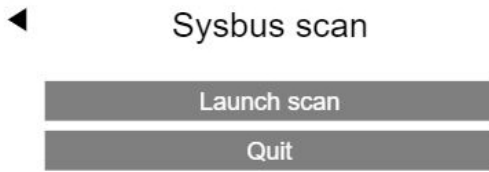

Fig. 07-14 Webpage: Sysbus scan

The result is shown on this page. The graphic on the right side show the setting of the DIP switches of the system bus address.

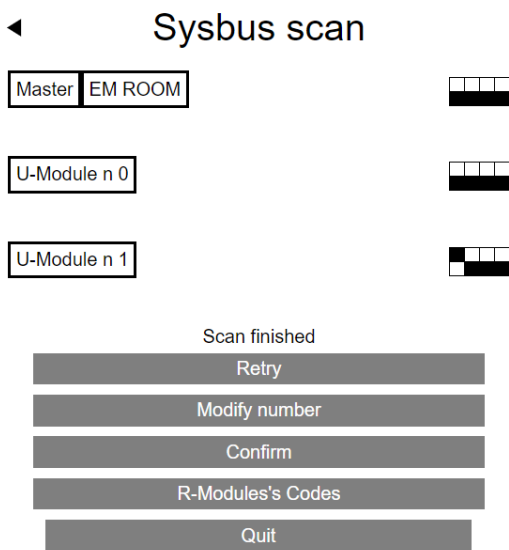

Fig. 07-15 Webpage: Sysbus scan, DIP switches

If the result of the system bus scan differs from what has been defined, an error message is displayed.

Please proceed as follows:

- Check the type and number of components entered
- Check the settings of the bus address switches
- Check the SYSBUS and ZOBUS LED of all components

Note:

The SYSBUS LED only flashes when the System Bus is active.

To check this, a second person has to start the system bus scan several times

→ Turn off power supply and check the bus cabling

07.05.08 Define function of system bus components

In this example, there are 2 U-modules, one of them has to be used for the mixed circuit.

U-Module1 (address 00) shall be used for the mixed circuit, U-Module2 (address 04) is used for 2 dehumidifiers.

The term "Dehumidification n 1" means the 1st group of dehumidifiers.

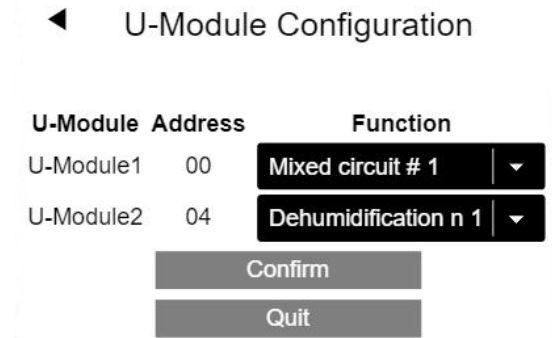

Fig. 07-16 Webpage: U-Module configuration, dehumidification

07.05.09 Input / output assignment of U-Modules for mixed circuit

◀ U-Module n 0
Mixed circuit # 1

Input/output	Function	Actual values	Acti- vation
AI 1	Mixed supply temp.	25.0	<input checked="" type="checkbox"/>
AI 2	Return temperature	24.7	<input checked="" type="checkbox"/>
AI 3	External temperature	--	<input type="checkbox"/>
AI 4			
DI 1	Dew point	0	<input type="checkbox"/>
DI 2	Mixed Circuit demand	0	
REL 1	Pump	0	

Pump high efficiency

Invert control signal

Mixed supply temp. offset

Return temperature offset

Adjust offset

Confirm

Confirm & test

Quit

◀ U-Module n 0
Mixed circuit # 1

Input/output	Function	Actual values	Acti- vation
AI 1	Mixed supply temp.	25.0	<input checked="" type="checkbox"/>
AI 2	Return temperature	24.7	<input checked="" type="checkbox"/>
AI 3	External temperature	--	<input type="checkbox"/>
AI 4			
DI 1	Dew point	1	<input type="checkbox"/>
DI 2	Mixed Circuit demand	0	
REL 1	Pump	0	

Pump high efficiency

Invert control signal

Mixed supply temp. offset

Return temperature offset

Adjust offset

Confirm

Confirm & test

Quit

Fig. 07-17 Webpage: U-Module, input/output

Options:

- Return temperature sensor, allows the boost mode in the heating up phase
- Digital input for dew point sensor

Note:

Contact is closed in „OK“ state.

- Pump as high-efficiency pump:
Increases the minimum running time of the pump (pump may run for a while when the mixing valve is in bypass mode)
- Adjust temperature measurement

Note:

The analogue input 3 is reserved for a wired outside temperature probe (later use).

If the offset values are modified, use "adjust offset" to verify the result.

Remark:

To improve the boost function, it is recommended to verify that flow and return temperature show the same value when

- Some manifold valves are opened
- The pump is running
- The Mixing valve is closed

Fig. 07-18 Webpage: U-Module, test outputs

The relay outputs and the analog output for the drive of the mixing valve can be operated via this website.

07.05.10 Definition of mixed circuit operating

The mixed circuit can be used for different systems in heating and cooling mode.

The setting influences parameters for

- Minimum and maximum temperature in heating and cooling mode
- Slope of the heat curve

◀ **Mixed circuit # 1**

	Heat	Cool
Floor	<input checked="" type="checkbox"/>	<input type="checkbox"/>
Wall	<input type="checkbox"/>	<input type="checkbox"/>
Ceiling	<input type="checkbox"/>	<input checked="" type="checkbox"/>

Confirm

Quit

Fig. 07-19 Webpage: Mixed circuit

07.05.11 Links between mixed circuits and manifolds

◀ **Manifolds**

Manifold #	
1	Mixed circuit # 1
2	Mixed circuit # 1

Confirm

Quit

Fig. 07-20 Webpage: Mixed circuits and manifolds

In this example, manifold 1 is used for underfloor heating, manifold 2 for ceiling cooling.

Note:

It is not a problem, that both manifolds are directly connected to the mixed circuit. There is no need to install valves which close one of the pipes in heating and another pipe in cooling mode. It would be also possible, to use one manifold for heating and cooling.

07.05.12 Input / output assignment of U-Modules for dehumidifiers

One U-Module can control 2 dehumidifiers.

When dehumidifiers are used which have an additional coil for cooling the intake air, REL 1 and REL 3 are used for opening a valve for each dehumidifier.

The manifold to which these valves belong have to be defined.

◀ **U-Module Dehumidifier 1**

U-Module Dehumidifier

1.1

REL 1	Dehum valve	<input checked="" type="checkbox"/>
	Manifold	2
REL 2	Dehum compressor	

U-Module Dehumidifier

1.2

REL 3	Dehum valve	<input checked="" type="checkbox"/>
	Manifold	2
REL 4	Dehum compressor	

Confirm & test

Confirm

Quit

Fig. 07-21 Webpage: U-Module Dehumidifier

When you use "Confirm & test", the outputs can be switched:

◀ **U-Module 4**

Outputs		Actual values
REL 1	<input checked="" type="checkbox"/>	1
REL 2	<input type="checkbox"/>	0
REL 3	<input checked="" type="checkbox"/>	1
REL 4	<input type="checkbox"/>	0
AO 1	<input type="text" value="0"/>	

Test outputs

Quit test

Fig. 07-22 Webpage: U-Module Output Test

07.05.13 Input / Output assignment of U-Modules for fan coils

A U-Module, configured for fan coil, can control up to 4 fan coils.

When a fan coil is later assigned to a room, the fan coil can be identified by the number selected in this step.

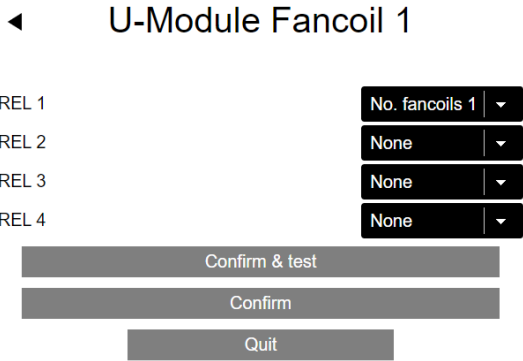

Fig. 07-23 Webpage: U-Module Fan Coils

07.05.14 Input/output assignment of U-Modules for Fan coil/Dehumidifier

A U-Module, configured for the combined use of fan coils and dehumidifiers, has a fixed assignment of the output relays:

- Relay 1: Fan Coil
- Relay 2: Compressor dehumidifier
- Relay 3: Fan Coil
- Relay 4: Compressor dehumidifier

U-Module Dehumidifier 1 Option Fancoil

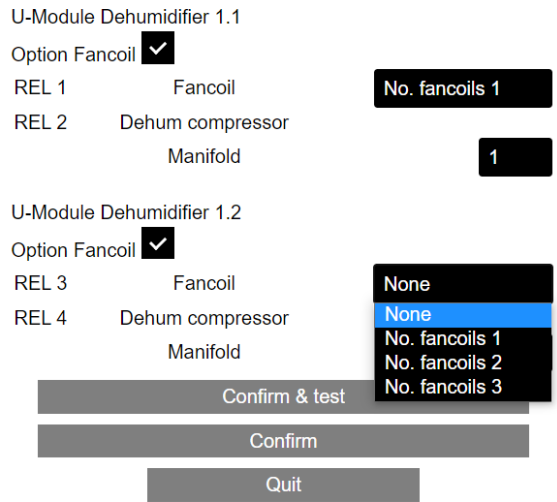

Fig. 07-24 Webpage: U-Module for dehumidifier and Fan Coils

In this case, it is not possible to control the valve for the hydraulic supply of the dehumidifier separately.

07.05.15 Overview of Base units

The next screen shows the present state of all existing NEA SMART 2.0 Base units (in this example only the master) with

- connected R-Module
- paired outside sensor
- predefined functions (here connected pump, boiler, chiller)

◀ **Device configuration**

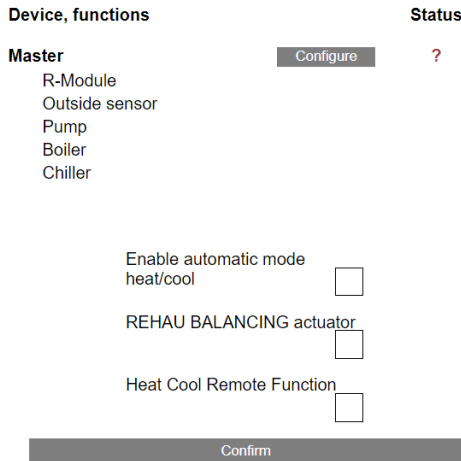

Fig. 07-25 Webpage: Device configuration

The configuration of the base is not been done, symbolized by "Status".

07.05.16 Definition of room operating modes

The „Configure“ button displays the configuration page of the Base (see picture below)

Here you can:

- Check which type of room controller has been paired with which channel (RZ) (e.g. Disp TH RC is a wireless room controller with display and temperature/humidity sensor)
- see the main RZ – this is the 1st channel with which the room controller was paired (this number is used to identify the rooms: the provisional names are Master-1, Master-4, where 1 and 4 are the main RZ)
- set which system is used (floor/ wall / ceiling)
- select the manifold which supplies the heating/ cooling system of this channel.
- set the operating mode of this channel:
(**H** **C** , **H** C , H **C**)

Annotations:

- Function of NEA SMART 2.0 Base (Master, Slave ...)
- Used heating / cooling system of channel
- Manifold which supplies the heating / cooling system of this channel
- Enable **HEATING** or **COOLING** or both

RZ	Room unit	Main RZ	Type	Manifold	Operating Mode
1	Disp T RC	1	Floor	1	H C
2	Disp T RC	1	Floor	1	H C
3	Disp TH Bus Ring	3	Floor	1	H C
4	Disp TH Bus Ring	3	Floor	1	H C
5	Disp T RC	5	Floor	1	H C
6	Disp T RC	5	Floor	1	H C
7	Disp T RC	7	Floor	1	H C
8	Disp T RC	7	Floor	1	H C
9	Disp T RC	1	Floor	1	H C
10	Disp T RC	1	Floor	1	H C
11	Disp TH Bus Ring	3	Floor	1	H C
12	Disp TH Bus Ring	3	Floor	1	H C

Fig. 07-26 Webpage: Overview Device configuration

After configuration of the room zones, the page shows the following:

Disp TH RC Main RZ 3 is paired to: zones 3, 4 - underfloor heating by manifold 1

and

zones 11, 12 - ceiling cooling by manifold 2 (R-Module connected to Master)

Probe T RC Main RZ 7 is paired to: zones 7, 8 - underfloor heating by manifold 1

Master Device configuration

RZ	Room unit	Main RZ	Type	Manifold	H	C
1	Disp TH RC	1	Floor	1	H	C
2	Disp TH RC	1	Floor	1	H	C
3	Disp TH RC	3	Floor	1	H	C
4	Disp TH RC	3	Floor	1	H	C
5	Disp TH Bus Ring	5	Floor	1	H	C
6	Disp TH Bus Ring	5	Floor	1	H	C
7	Probe T RC	7	Floor	1	H	C
8	Probe T RC	7	Floor	1	H	C
9	Disp TH RC	1	Ceiling	2	H	C
10	Disp TH RC	1	Ceiling	2	H	C
11	Disp TH RC	3	Ceiling	2	H	C
12	Disp TH RC	3	Ceiling	2	H	C

Disp TH RC Main RZ 1 is paired to: zones 1,2 - underfloor heating by manifold 1

and

zones 9, 10 - ceiling cooling by manifold 2 (R-Module connected to Master)

Disp TH BUS Main RZ 5 is paired to: zones 5, 6 - underfloor heating by manifold 1

Fig. 07-27 Webpage: Settings according to the example

Next step is to configure the outputs and inputs.

07.05.17 Definition of Fan Coils at Room Zones (RZ)

It is possible to assign a fan coil directly to a channel of a Base (RZ, Room Zone), which is paired to a Room unit.

In this case, the fan coil is automatically assigned to the Room unit, which is paired with this room zone.

There is no fan coil number that needs to be selected. The options "Manifold", "Heating" and "Cooling" do not appear.

Attention:

The switching of the fan coil can be done only by using a REHAU switching relay

Master Device configuration

RZ	Room unit	Main RZ	Type	Manifold	H	C
1	Disp T RC	1	Floor	1	H	C
2	Disp T RC	1	Fancoil	1	H	C
3	Disp TH Bus Ring	3	Floor	1	H	C
4	Disp TH Bus Ring	3	Floor	1	H	C
5	Disp T RC	5	Fancoil	1	H	C
6	Disp T RC	5	Floor	1	H	C
7	Disp T RC	7	Fancoil	1	H	C
8	Disp T RC	7	Floor	1	H	C
9	Disp T RC	1	Ceiling	2	H	C
10	Disp T RC	1	Ceiling	2	H	C
11	Disp TH Bus Ring	3	Ceiling	2	H	C
12	Disp TH Bus Ring	3	Ceiling	2	H	C

Configure outputs and inputs

Confirm

Confirm & test

Quit

Fig. 07-28 Webpage: Settings fan coil

07.05.18 Definition of outputs of the Base

The screen below shows the default output configuration of a master. The function of each of the below options is described in chapter 5.3.6.

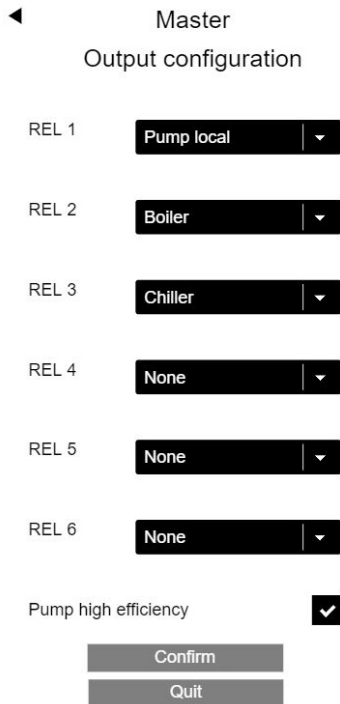

Fig. 07-29 Webpage: Master, output configuration

In our example, additional output signals are added:

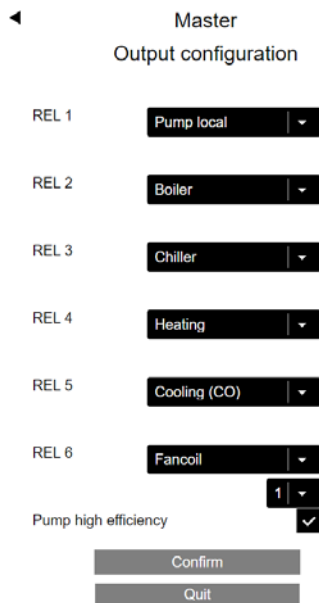

Fig. 07-30 Webpage: Master, output configuration (Heating, Cooling)

The signals "Heating" and "Cooling" may be used to control valves which open or close the supply pipes coming from boiler and chiller.

07.05.19 Definition of inputs of the Base

By default, there are no input signals defined. The options are shown below. The function of each of the below options is described in chapter 05.03.05.

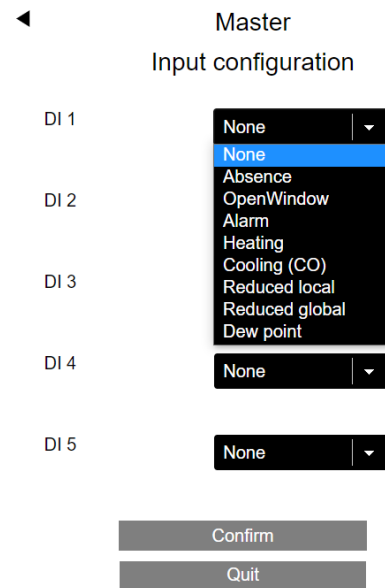

Fig. 07-31 Webpage: Master, input configuration

In our example, these input signals have been added.

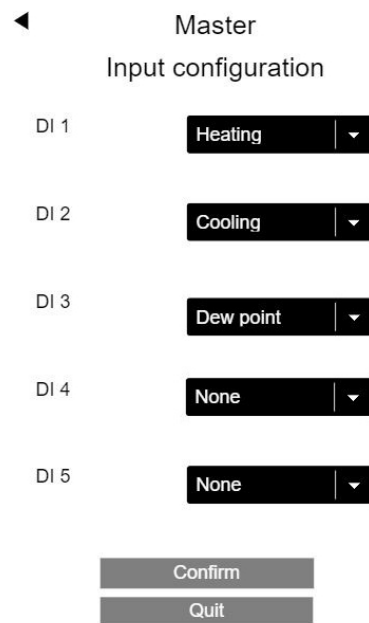

Fig. 07-32 Webpage: Master, input configuration

Note:

Dew point signal and "Window open" are defined to be OK (no dew point alarm, window is closed) when the signal is active.

This means, the potential free contact connected to this input is closed in OK state.

07.05.20 Automatic mode and remote control of the operating mode

When the base(s) are configured, the wizard returns to the page where the overview appears and now displays the OK status.

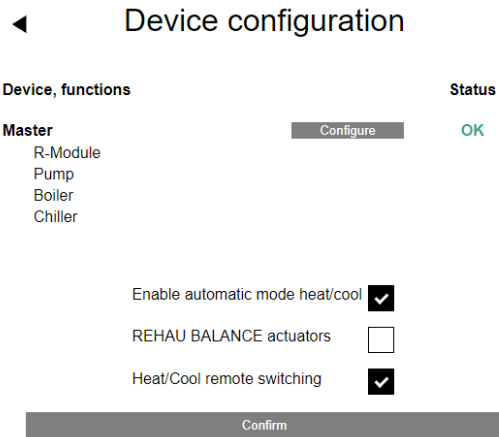

Fig. 07-33 Webpage: Configuration Devices

Depending on the configuration the following check-boxes appear (only for heating and cooling systems):

- Enable automatic mode heat/cool
This option is only displayed if an input signal „Heating“ or „Cooling“ or an output signal „Heating“ or „Cooling“ is defined
- Heat/Cool remote switching
This option is only displayed if an input signal „Heating“ or „Cooling“ is defined



The option „Enable automatic mode heat/cool“ allows the operating modes „Heating“ and „Cooling“ via a potential-free contact, which is connected to an input defined as „Heating“ or „Cooling“. If the „Heating/Cooling“ mode is selected, the NEA SMART 2.0 system follows the input signals without delay.

If none of the above conditions in a heating/cooling system are fulfilled, the following message appears.



Warning:

This installation is configured for heating and cooling. There are no output signals or input signals defined to ensure proper change between heating and cooling mode. You have to ensure by other means to avoid damage or problems when the system is switched between heating and cooling.

The automatic switching between heating and cooling is deactivated in this case.

At the end you get a confirmation, that the system configuration is completed.

System configuration completed

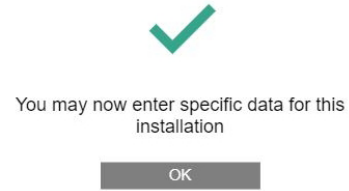

Fig. 07-34 Webpage: System configuration completed

After pressing OK you come to installer area for further settings.



Once the system configuration is done, there is a time delay of about 10 minutes before the NEA SMART 2.0 system will start working. During this time, all data from all components is processed and analysed.

07.06 Installer main menu

Installer main menu

- System set up procedure
- Rooms
- Timer programs
- Settings
- System
- Diagnosis/Calibration

Exit installer menu

Fig. 07-35 Webpage: Installer main menu

The installer main menu offers the following options:

- Go back to System set up procedure (Wizard)
- Set room names, define set points, declare room as pilot room, set function of external input of room unit ...
- Modify weekly and daily timer programs
- Adjust all parameters
- Set language, define heating and cooling period ...
- System components, state of inputs and outputs of all components, calibrate sensor inputs

07.06.01 Timer programs

◀ **Timer programs**

Daily programs

Weekly programs

Fig. 07-36 Webpage: Timer programs

There are 5 weekly programs and 10 daily programs.

For each day of the week, a different daily program can be chosen.

The weekly programs are applied for the room temperature set points, for the fan coils and for the dehumidifiers.

◀ **Daily programs**

- Daily program 1
- Daily program 2
- Daily program 3
- Daily program 4
- Daily program 5
- Daily program 6
- Daily program 7
- Daily program 8
- Daily program 9
- Daily program 10

Fig. 07-37 Webpage: Daily program selection

◀ **Weekly program no. 1**

Monday	1	▼
Tuesday	1	▼
Wednesday	1	▼
Thursday	1	▼
Friday	1	▼
Saturday	2	▼
Sunday	2	▼

Confirm

Fig. 07-38 Webpage: Weekly program selection

Daily program set up

◀ **Daily program 1**

Delete all

Add time span

Start time:

End time:

Add time span

Confirm program

Fig. 07-39 Webpage: Set up daily program

The standard program for working days is defined as follows:

Normal mode from 06h to 8h and from 16h to 22h.

The rest of the day is reduced mode.

All normal mode time spans can be deleted, additional time spans can be added:

◀ **Daily program 1**

Delete all

Add time span

Start time:

End time:

Add time span

Confirm program

Fig. 07-40 Webpage: Set up daily program, delete

Note:

When Autostart function is enabled in room configuration, the system tries to reach the set points for normal mode in time at the begin of the defined time period.

The time span determined for the autostart function is continuously updated.

During this period, fan coils continue to work with the value specified in the time program in order to give priority to the other systems.

◀ **Daily program 1**

Delete all

Add time span

Start time:

End time:

Add time span

Confirm program

Fig. 07-41 Webpage: Set up daily program, new time span

After confirmation the time span in the morning is enlarged.

07.06.02 Room set up

Rooms	
Master - 1	24.4
Master - 3	24.5
Master - 5	24.3
Master - 7	24.4

Fig. 07-42 Webpage: Room set up

When you enter the menu for rooms, the room names are corresponding to the Main RZ (Master-1 is RZ 1, see paragraph 07.05.14).

Installer page for room

Rooms

1

Livingroom

22.5

2

26,0

19,0

3

24,0

26,0

4

15,0

Humidity : 44 %

Weekly program

5

1

6

i

7

No dehumidifier

8

CC Channel used

9

Pump

10

Cool

11

ECO

12

Fancoil Active in Reduce

13

Fancoil Stop

14

Enable auto start

15

Pilot room

16

Display lock

17

Heating
Cooling (CO)

18

Function of additional input
P2

19

Remote temperature :
21.3

20

Remote sensor high limit (heating)
Remote sensor low limit (heating)
Remote sensor low limit (cooling)

30,0

20,0

19,0

21

Version : 01.02

Confirm

The actual values of room temperature and humidity are shown on this page.

- 1 Change room name
 - 2 Define room temperature set points for Heating normal / reduced mode
 - 3 Cooling normal / reduced mode
 - 4 Heating holiday (absent) mode
- Note:
- Cooling is stopped in holiday mode
- 5 Select weekly program for room temperature set points
 - 6 Info button shows the daily programs for the selected weekly program
 - 7 Choose one of the dehumidifiers for this room
 - 8 Assigned fan coil
 - 9 Supply of fan Coil
 - 10 Using heating, cooling or heating / cooling
 - 11 Selection comfort level of fan coil
 - 12 Activation of the fan coil during reduced mode
 - 13 Lock fan coil
 - 14 Auto start function
 - 15 Important rooms like living room should be pilot rooms, they take influence on begin and end of heating / cooling mode and on flow temperature
 - 16 Display of room unit can be locked
 - 17 Enable / disable heating and cooling of this room
 - 18 Set function of external input (P2 = floor temperature sensor) see parameter list in chapter 07.04.06
 - 19 Shows the actual value of floor temperature sensor
 - 20 Set the limits for the connected floor temperature sensor
 - 21 Software version of room unit

Fig. 07-43 Webpage: Installer page for room

07.06.03 System data

Fig. 07-44 Webpage: System data

Note:

The "System" page is present in the user area, too.

Some of the settings are already done during wizard run, as language, building type and building energy class, but can be modified here.

Temperature unit can be switched between Fahrenheit and Celsius System date and time has been set during wizard and can be adjusted here.

The time spans for heating (1st of October until 1st of may) and cooling period (1st of June until 1st of September) are predefined.

They can be adjusted or completely disabled.

Note:

The defined time span is the permission for the system to enter this mode.

Depending on the system configuration it is also possible, to overrule the defined periods.

The summertime (daylight saving time) is disabled, when 00-00 is entered.

Heating mode starts, when the average value of the outside temperature falls below 15 °C. This limit can be increased or decreased.

Unique code is the identifier for the base in cloud connection Software versions of installed components.

Note:

The software of the base will automatically updated via the server if this option has been enabled in the NEA SMART 2.0 app.

07.06.04 Diagnosis / probe calibration

Fig. 07-45 Webpage: Diagnosis

The Diagnosis page is for the installer.

System statistics show the runtime of the system and other values.

Configuration overview lists the components of the system.

State of inputs / outputs can be used to verify correct operating of connected devices and the digital and analogue inputs / outputs of system components.

07.06.05 Settings (Parameters)

Fig. 07-46 Webpage: Settings

Settings page contains the most relevant parameters, additional parameters can be modified in the REHAU NEA SMART 2.0 App Influences activation of heating cooling mode.

Flow temperature setting and control behaviour of mixed circuits.

Pump, boiler, chiller minimum run times, pause times ...

Pump and valve kick ...

Parameter for room temperature control.

Activation limits of dehumidifiers.



The listed points are examples.

For detailed information about the parameters which are available here and the complete set of parameters available in the NEA SMART 2.0 App see chapter 8.

07.07 Reset functions

07.07.01 Delete pairing of all channels (RZs) on a base

- Start the pairing sequence by pressing OK for > 3 sec.
- Base switches on LEDs of all paired channels
- 1st not paired channel is blinking in a "slow sequence"
- Channel, that shall be deleted, can be selected by < or > key
- Confirm channel by pushing OK less than a second
- < and > is pressed together for > 3 secs
- This paired channel starts fast blinking
- Pairing of this channel is deleted, LED is switched OFF
- Push OK button for 3 seconds to leave pairing mode

07.07.02 Delete pairing of outside temperature probe

- Start the pairing sequence by pressing OK for > 3 sec.
- Base switches on LEDs of all paired channels, OK button shall be released during maximum 2 secs
- Do not press OK to select the blinking channel
- < and > is pressed together for > 3 secs
- All channels are blinking as a confirmation
- Push OK button for 3 seconds to leave pairing mode

07.07.03 Reset Controller to initial state

- Press OK for 3 secs
- Controller enters pairing sequence
- Press <, OK and > together for > 10 secs
- All LED's are flashing, controller restarts

07.07.04 Reset Room Unit

- For wireless Room unit: Remove battery, push home button several times (to kill remaining current) and place batteries back
- For bus wired Room unit: open room unit to unpower, push home button several times (to kill remaining current) and close room unit again
- Push home button, and immediately after the area where + and – are
- Room unit will show a circle
- Release + and – area
- Push Home button until display turns off

07.07.05 Reset room probe

- For wireless Room probe:
Open housing and remove battery
Press button at the bottom of the housing several time, insert battery, press the button immediately long (more than 5 seconds)
Flashing of the LED stops
- For bus based Room probe
open housing
Press button at the bottom of the housing several time, insert battery, press the button immediately long (more than 5 seconds)
Flashing of the LED stops

07.07.06 Reset WIFI Key to default setting

- Press < and > for 3 secs
- LED "WIFI" is flashing, independent of previous state of WIFI
- Press <, OK and > for 10 secs
- As a confirmation of successful reset of WIFI key the LED of WIFI and WIFI/AP are blinking alternating for 5 secs



Tutorials for the functions described above can be found at: www.rehau.com/neasmart2

08 Operating of NEA SMART 2.0 System

The NEA SMART 2.0 System can be operated and monitored by user, installer and service company using

- the NEA SMART 2.0 Room units
(change set points, operating mode ...)
- Integrated web pages
(set up, parametrization, timer programs, room set points..)
- NEA SMART 2.0 App
(all parameters adjustable, display of statistics)

The widest range of possibilities and highest comfort offers the NEA SMART 2.0 App. To use the App, the system must be connected to internet.

The integrated web pages can be accessed by one device only. Internet connection is not needed, and in this mode also not possible.

Operating by room units is always possible and does not exclude, to operate the system in parallel by App or web pages.

The table below gives an overview about the features and limits of the different operating methods.

Feature	Room unit	Webpage	App
Change actual temperature set points, select normal / reduced / standby / party mode for one room	YES	YES	YES
select normal / reduced / standby / party and holiday mode for all or a group of rooms	NO	YES, with some restrictions	YES
Manage timer programs, room temperature set points in timed mode	NO, but predefined set points can be changed	YES	YES
Manage dehumidifiers	NO	YES	YES
Set up a system	Only room temperature control heating without timer functions	YES	NO, configuration must be done with web pages
Change parameters	NO	YES, with some restrictions	YES
Get error messages	Only critical as condensation	Only error codes	YES
Display of statistics, temperature curves, etc.	NO	NO	YES
Use smart functions as geofencing	NO	NO	YES

Tab. 08-1 Operating via different devices

08.01 Operating by NEA SMART 2.0 Room units

08.01.01 Display information



The display is switched off during sleep mode. It is activated by pressing the Home button. Only then the plus/minus symbols become visible. Flashing symbols or numbers can be modified.

Fig. 08-1 NEA SMART 2.0 Room Unit

The Room unit is operated using the Home button and the +/- symbols.

MINUS SYMBOL

- Reduce the desired temperature
- Previous menu item

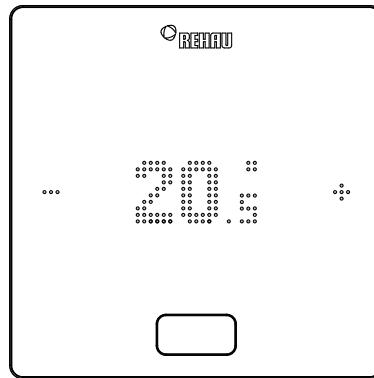

PLUS SYMBOL

- Increase the desired temperature
- Next menu item

HOME Button

- Activate display
- Next menu item
- Confirm

Display of temperature

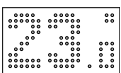

Shows the current room temperature or the setpoint of room temperature.

Display of room humidity

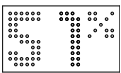

Shows the relative humidity in the room*.

Display of operating mode



Heating mode
Heating mode is active

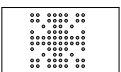

Cooling mode*
Cooling mode is active

Operating status

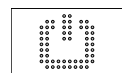

Standby
Heating and cooling mode disabled

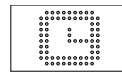

Timer program
Room is controlled via timer program



When the symbol for timer program is displayed, the set operating status is displayed afterwards (Normal or Reduced).

* Is displayed, if this function can be activated or if a sensor is integrated.

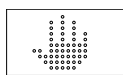

Manual
User has changed the Setpoint; valid until the next switching point

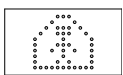

Normal
Operating mode Normal is active

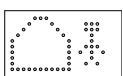

Reduced
Operating mode Reduced is active (energy-saving mode)



Transitional phase Normal
Transitional phase Normal to Reduced operating mode

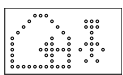

Transitional phase Reduced
Transitional phase Reduced to Normal operating mode

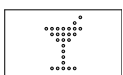

Party
Party mode is active

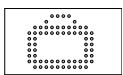

Holiday
Holiday mode is active

Room unit locked

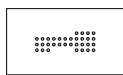

Buttons are locked

Error message

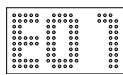

Warning message

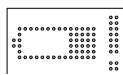

Low battery
The battery of the Room unit must be replaced.

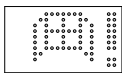

Open window
An open window has been detected in this room.

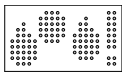

Condensation
High humidity – risk of condensation.

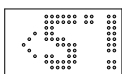

Frost protection active
Frost protection has been activated as the temperature has fallen below 5 °C; the heating valve is activated

Connection status

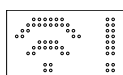

No connection
There is no connection to the Base.

08.01.02 Order of the displayed information

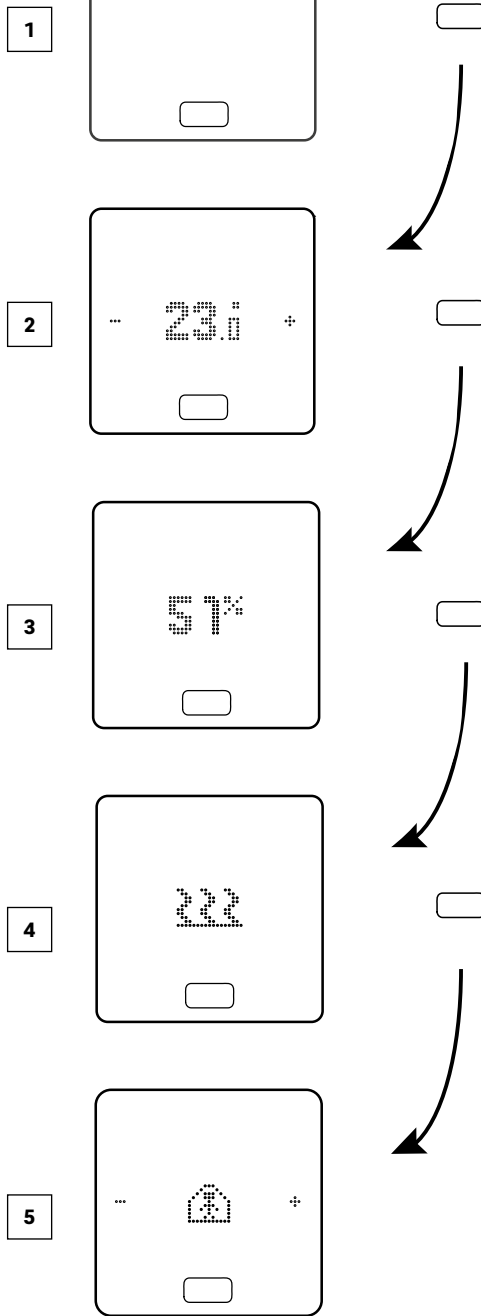

- 1 Initial state
- 2 Display of current room temperature
- 3 Display of current humidity in the room
- 4 Display of operating mode Heating or cooling
- 5 Display of operating status

08.01.03 Setting the Setpoint of room temperature

To activate the display, press the Home button once.
To see the Setpoint, press +/- once.

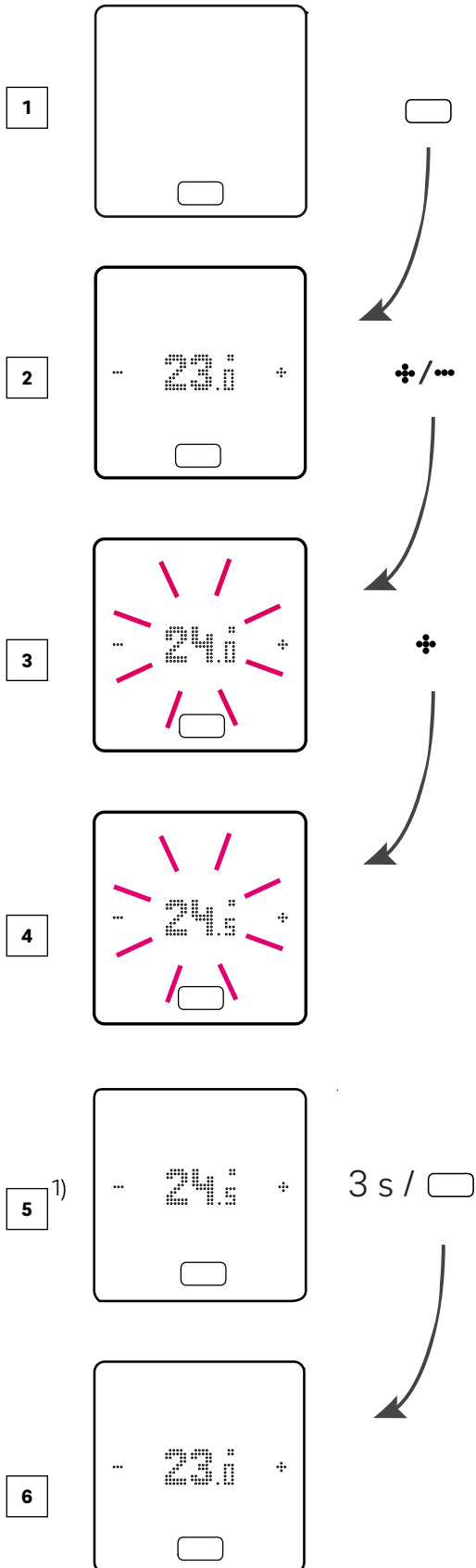

¹⁾ optional: If room unit has a light ring, it flashes additionally for confirmation.

- 1 Initial state
- 2 Display of current room temperature
- 3 Display of actual setpoint of room temperature
- 4 Display of adjusted setpoint of room temperature during operation
- 5 Display of final adjusted setpoint of room temperature
- 5 Display of current room temperature

08.01.04 Operating status

The current operating status is displayed after pressing the Home button 4 times. It can be changed by pressing +/- . The current operating status is always displayed first. This means that the order can deviate from the image.

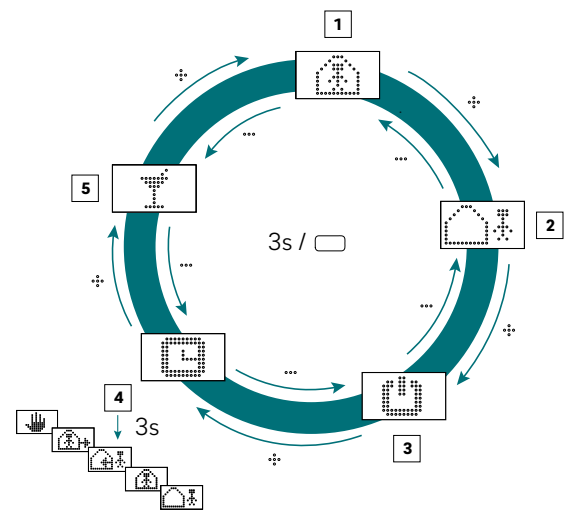

Fig. 08-2 Room unit selection operation mode

- 1 **Normal mode**
Standard Setpoint 21 °C
- 2 **Reduced mode**
Standard Setpoint 18 °C
- 3 **Standby mode**
Heating and cooling mode disabled
- 4 **Automatic mode**
The selected time program for the room is active
- 5 **Party**
Party mode is activated for 4 hours



The party mode allows the user to switch from the reduced mode to the normal mode for a selected time. The room unit automatically returns to the reduced mode when the party time has elapsed.



When standby mode is selected, automatic frost protection is active. As soon as the temperature drops below 5 °C, the heating valve is activated.

Special for Holiday mode:

The holiday mode can only be activated via App or webpage. The holiday symbol appears only at the display when holiday mode is activated.

08.02 Operating by web pages

08.02.01 Connect a device

The procedure how to connect a smartphone, tablet or laptop with the NEA SMART 2.0 Base is described in chapter 7 of this manual.

08.02.02 User area

Depending on the type of system, the integrated web pages offer the following options:

- Selection of the operating modes of the system:
 - Heating/cooling:
 - via time program or continuously in normal, reduced or standby mode
- Managing the timer programs
- Specification and management of room temperature
- Using the party or holiday function
- Specification of the mode of operation of the dehumidifiers
- Connecting the system to the Internet to use the App
- Additional setting options

Main menu

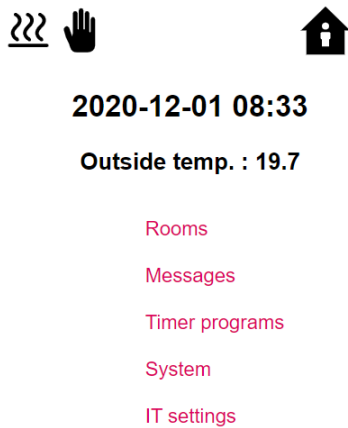

Fig. 08-3 Webpage: Main menu

In the main menu, you can see the current operating mode – shown here: Heating mode and “normal” mode (person in the house).

By clicking the symbols, the different operating modes can be selected (depending on the present conditions):

- Heating mode, manual
- Cooling mode, manual
- Heating mode, automatic start
- Cooling mode, automatic start

and:

- Operation via time programme
- Permanent “normal” or “reduced” mode
- System switched off (standby)



In order to ensure comfortable conditions and an energy-efficient operation, we recommend that you select the timed operating mode.

Click the menu items to access the respective submenus.

Room selection

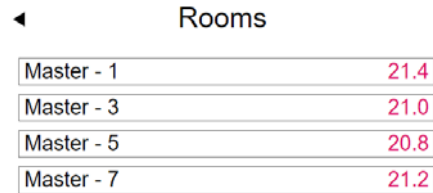

Fig. 08-4 Webpage: Room selection

Here, you can see the individual rooms with their current room temperatures. Clicking a room takes you to the individual room pages.

Room page:

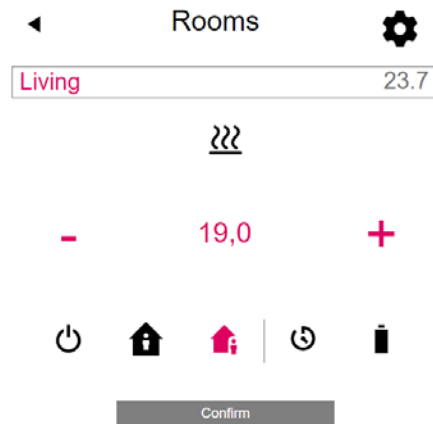

Fig. 08-5 Webpage: Adaptions in Room

Here, the current target and actual temperature and the operating mode (here: heating mode, via time program, currently “normal” mode) are displayed.

The room temperature target value can be changed using the plus and minus symbols.

Note:

- Changes to the room temperature target value during timed operating mode are valid until the next switching point of the time program
- Changes during fixed "normal" or "reduced" mode are set as new standard values for this mode.
- By clicking the gear symbol, you can access the advanced settings ...

Extended room page:

Fig. 08-6 Webpage: Detailed adaptations in room

The standard values for heating/cooling can be managed here for "normal" or "reduced" mode as well as for holiday mode.

There are five weekly programs available. By clicking the info symbol, you will see a preview of the selected timer program.

The auto-start function ensures that the desired room temperature is reached at the defined point in time. If the auto-start function is not selected, the room is only heated or cooled to the new default value from the point in time selected in the timer program.



Rooms that are also equipped with a fan coil should always be operated with the activated autostart function. The autostart function gives the surface heating / cooling system the opportunity to bring the room to the desired temperature according to the timer program in the most energy-saving and also noiseless manner without starting the fan coil prematurely.

Using the display lock, the operation of the room unit can be blocked.

If a ground temperature sensor is installed, the limit values to be observed for heating and cooling mode can be specified.

Timer programs:

Fig. 08-7 Webpage: Timer program

The 5 weekly programs consist of daily programs for the individual days. There are 10 daily programs that can be defined in a 15-minute time grid.

The displayed sections are rounded to one hour.

The areas marked in red indicate the periods of time defined for "normal" mode.

Note:

A number of programs are predefined but can be changed at any time. Based on the selection of the building type (residential building, office building), the appropriate timer programs are selected automatically.

System

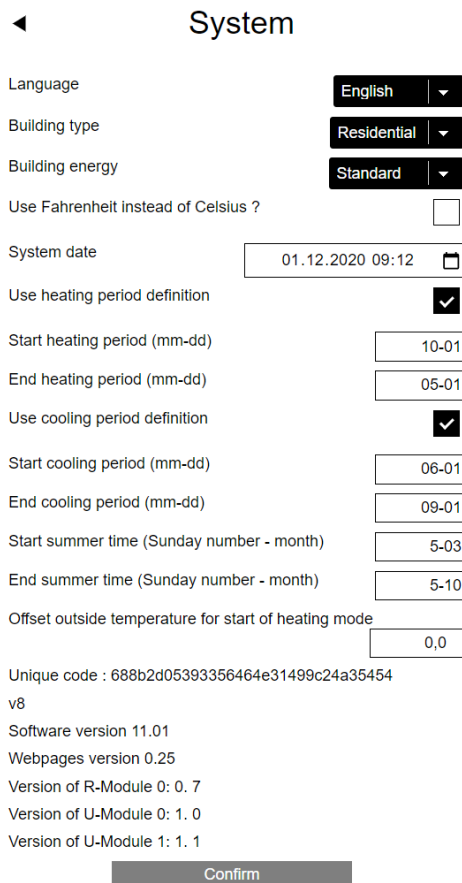

System

Language English

Building type Residential

Building energy Standard

Use Fahrenheit instead of Celsius ?

System date 01.12.2020 09:12

Use heating period definition

Start heating period (mm-dd) 10-01

End heating period (mm-dd) 05-01

Use cooling period definition

Start cooling period (mm-dd) 06-01

End cooling period (mm-dd) 09-01

Start summer time (Sunday number - month) 5-03

End summer time (Sunday number - month) 5-10

Offset outside temperature for start of heating mode 0,0

Unique code : 688b2d05393356464e31499c24a35454
v8
Software version 11.01
Webpages version 0.25
Version of R-Module 0: 0.7
Version of U-Module 0: 1.0
Version of U-Module 1: 1.1

Confirm

Fig. 08-8 Webpage: System

On the system page, you can make additional settings:

- Language
- Classification of the building's energy requirements
- Time and date
- Determination of permissible times for heating and cooling mode
- Changing the start-up criteria for heating mode

Note:

Depending on the present system, some standard values may not be effective.

On other web pages, you can make additional IT settings and settings for other components.

Dehumidifier:

Dehumidifiers are required depending on climatic conditions.

The dehumidifiers are assigned to individual rooms in the extended part of the room page.

If your system is equipped with dehumidifiers, you can configure them starting from the main menu in the „Dehumidifier“ menu.

Dehumidifier settings

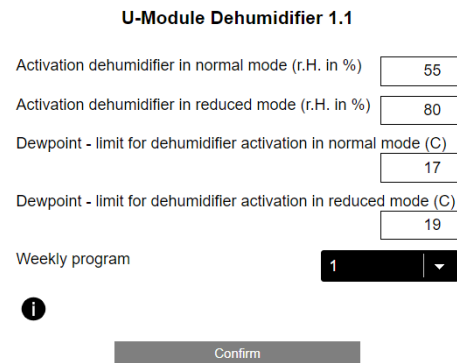

U-Module Dehumidifier 1.1

Activation dehumidifier in normal mode (r.H. in %) 55

Activation dehumidifier in reduced mode (r.H. in %) 80

Dewpoint - limit for dehumidifier activation in normal mode (C) 17

Dewpoint - limit for dehumidifier activation in reduced mode (C) 19

Weekly program 1

Confirm

Fig. 08-9 Webpage: Dehumidifier

The dehumidifiers are controlled by a weekly program, which switches between normal and reduced operation, same as it is with the setpoints for the room temperature. The reduced operation, usually during the night, reduces the impairment caused by the inevitable operating noise of the devices.

The values for reduced operation have therefore been intentionally chosen in such a way that in this phase the dehumidifiers are only started when it cannot be avoided.

Default values:

relative humidity (r.H.):

normal / reduced operation:
55 % r.H. / 80 % r.H.

The relative humidity indicates the extent to which the air is saturated with moisture. Too high humidity is perceived as unpleasant, and it can even lead to condensation on cool surfaces. Too low humidity can lead to skin irritation and breathing problems. Ideal is a humidity in the range of 40 % to 50 %. The setting value for the reduced operation is therefore the absolute upper limit, which should not be exceeded.

Dew point:

normal / reduced operation: 15 °C / 17 °C

The dew point indicates at which surface temperature condensation occurs on this surface (at the current relative humidity). In a radiant cooling system, the cooled surfaces have a temperature of about 17 °C to 23 °C, depending on type of installation and settings. In order to avoid condensation on these surfaces, again, the limit value for reduced operation is the absolute upper limit.



Changes should not be made without consulting the installer. Correct setting values of the dehumidifiers ensure safe operation of surface cooling and they also have a decisive influence on efficiency.

Inappropriate settings may lead to condensation on the cooled surfaces. In this case there is a risk of slipping, as well as damage to the surfaces or the entire components.

IT settings:

This is where the settings are made that allow the system to connect to the router via WLAN. The system must be connected to the Internet in order to use the NEA SMART 2.0 app.

IT settings

Router SSID

Router password

Password for access point (AP) mode

Confirmation password for access point (AP) mode

IP Server: 0.0.0.0

Confirm

Fig. 08-10 Webpage: IT settings

Network SSID:

Insert here the WiFi network name of your router

WPA2 key of WiFi network:

Password (WPA2 key) of your router

Insert CA hash:

In case that the certificate of the system is expired, the CA hash of the new certificate must be entered here. The certificate will only expires if the Base has not been online for several years.

Further information under

www.rehau.com/neasmart2

08.02.03 Installer area

The graph below shows the complete installer menu structure.

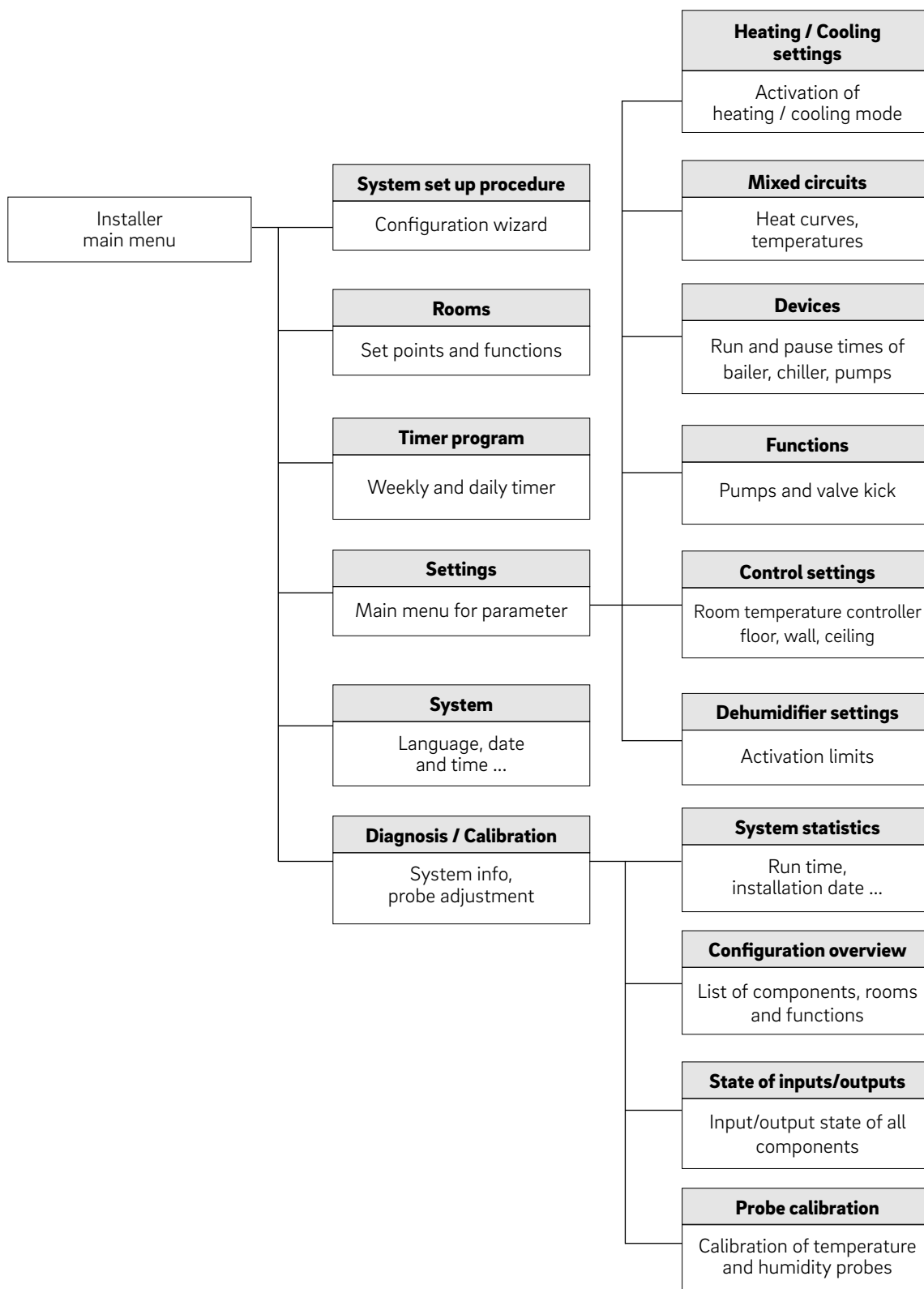

Fig. 08-11 Webpage: Installer menu structure

Access to installer main menu

The installer area may be entered from user menu:

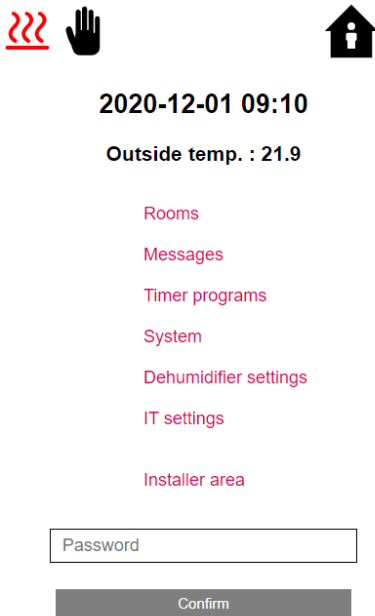

Fig. 08-12 Webpage: User menu

The password are the first 8 characters of the unique code. The unique code can be found:

- on the label that is at the bottom of the NEA SMART 2.0 Base, or
- on the web page "System" that is shown in the screen above (see also chapter 07.06.03)

Installer main menu:

Installer main menu

- System set up procedure
- Rooms
- Timer programs
- Settings
- System
- Diagnosis/Calibration

Exit installer menu

Fig. 08-13 Webpage: Installer main menu



The following pages show the installer menus as they exist in the example described in the installation sequence in chapter 7.

For detailed information about the displayed parameters see chapter 9.

In this chapter the following menu items are not described:

- "System set up procedure": This starts the wizard again. This can be used to see the detailed configuration of the system also without changing anything. see chapter 7
- "Rooms" see chapter 07.06.02
- "Timer programs" see chapter 07.06.01

Settings

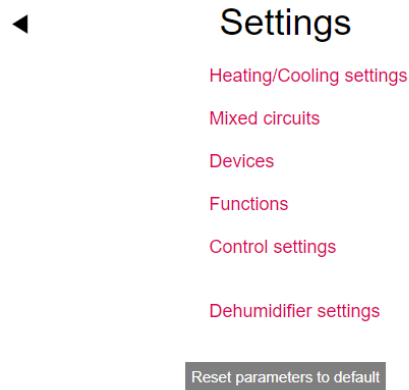

Fig. 08-14 Webpage: Settings

Heating / Cooling settings

◀ Heating/Cooling settings

Filter time for outside temperature (in h)	48
Heating limit normal mode (C)	15,0
Heating limit absence mode (C)	13,0
Cooling mode start delay time (in min)	60
Cooling mode minimum run time (in min)	60
Heating mode off-time after cool mode (in h)	12
Enable summer compensation	<input checked="" type="checkbox"/>

Confirm

Fig. 08-15 Webpage: Heating / Cooling settings

Mixed circuits

◀ Mixed circuits

Mixed circuit # 1

Heat curve starting point normal mode (C)	<input type="text" value="20"/>
Heat curve starting point absence mode (C)	<input type="text" value="17"/>
Heat curve slope in normal mode	<input type="text" value="0,6"/>
Heat curve slope in absence mode	<input type="text" value="0,6"/>
Mixed supply temp. reduction in reduced mode (in K)	<input type="text" value="4"/>
Minimum value of supply temperature in heating mode (normal) (C)	<input type="text" value="25"/>
Min. value of supply temperature in heating mode (absence) (C)	<input type="text" value="20"/>
Maximum value of supply temperature in heating mode (normal) (C)	<input type="text" value="45"/>
Maximum value of supply temperature in heating mode (absence) (C)	<input type="text" value="40"/>
Filter time for outside temperature (in h)	<input type="text" value="48"/>
Boost mode allowed	<input checked="" type="checkbox"/>
Min.value supply temp. cooling mode (normal) (C)	<input type="text" value="16,0"/>
Mixed supply temp. : safety distance to dew point (in K)	<input type="text" value="2,0"/>
Return temperature limit in cooling mode (C)	<input type="text" value="18,0"/>
Proportional band-width heating circuits (in K)	<input type="text" value="20,0"/>
Proportional band-width cooling circuits (in K)	<input type="text" value="10,0"/>
Integral time mixed circuits (in sec)	<input type="text" value="60"/>
Delay time for enabling PI-Controller (in sec)	<input type="text" value="15"/>

Fig. 08-16 Webpage: Mixed circuits settings

Devices

◀ Devices

Boiler

Minimum demand time heating device (in min)	<input type="text" value="1"/>
Delay time heater demand signal (in min)	<input type="text" value="1"/>
Heater blocking time before restart (in min)	<input type="text" value="3"/>

Chiller

Minimum demand time for chiller (in min)	<input type="text" value="1"/>
Delay time for chiller demand signal	<input type="text" value="1"/>
Chiller blocking time before restart (in min)	<input type="text" value="3"/>

Mixed circuit # 1

Position of mixing valve for heating demand (%)	<input type="text" value="30"/>
Hysteresis of mixing valve position for heating demand signal (%)	<input type="text" value="5"/>
Position of mixing valve for cooling demand (%)	<input type="text" value="30"/>
Hysteresis of mixing valve position for cooling demand signal (%)	<input type="text" value="5"/>
Invert control signal	<input type="checkbox"/>
Pump antiblock function run time	<input type="text" value="5"/>
Valve antiblock function period	<input type="text" value="90"/>

Pump Mixed circuits

Start delay (min) of pump for mixed circuit 1	<input type="text" value="4"/>
Overshoot time (min) of pump for mixed circuit 1	<input type="text" value="1"/>

Fig. 08-17 Webpage: Devices settings

Functions

◀ Functions

Master Pump high efficiency	<input checked="" type="checkbox"/>
Mixed circuit # 1 Pump high efficiency	<input checked="" type="checkbox"/>
Enable pump antiblock function (YES/NO)	<input checked="" type="checkbox"/>
Pump antiblock function period (in days)	<input type="text" value="90"/>
Pump antiblock function start time (in h)	<input type="text" value="3"/>
Enable valve antiblock function (YES/NO)	<input checked="" type="checkbox"/>
Valve antiblock function start time (in min)	<input type="text" value="3"/>
Valve antiblock function run time (in min)	<input type="text" value="5"/>

Fig. 08-18 Webpage: Functions settings

Control settings (here shown for floor only)

Control settings

Floor

Proportional bandwidth heating mode (in K)

Proportional bandwidth cooling mode (in K)

Pulse period time of room temp. control (in min)

Minimum pulse length room temp. control (in min)

Integral time room temperature control (in min)

Integral part limitation (in %)

Optimization factor for room temp. control

Pulse length threshold for continuous mode (%)

Shift of proportional band (%)

Fig. 08-19 Webpage: Control settings

Fan Coil Einstellungen

On this page the minimum and maximum runtimes of the fan coils can be defined and the configuration is displayed (number of used fan coils and relay outputs)

Annotation:

In Fig. 08-20 the fan coils do not have a valid number (255) because they are assigned directly to a room unit and are controlled via the RZ-outputs of the base.

In Fig. 08-21 the fan coils are controlled via the relay outputs 3, 4 and 7 of the base.

Devices

Fan coil

Minimum run time (minutes)

Maximum run time (minutes)

Minimum pause time (minutes)

Fancoil System configuration

Master - 1 : Fan coil No255 : None
 Master - 3 : Fan coil No255 : None
 Master - 5 : Fan coil No255 : None

Confirm

Fig. 08-20 Fan Coils controlled via RZ-outputs of the Base

Devices

Fan coil

Minimum run time (minutes)

Maximum run time (minutes)

Minimum pause time (minutes)

Fancoil System configuration

Master - 1 : Fan coil No255 : Master D03
 Master - 3 : Fan coil No255 : Master D04
 Master - 5 : Fan coil No255 : Master D07

Confirm

Fig. 08-21 Fan Coil controlled via relay outputs of the Base

Dehumidifier settings

Dehumidifier settings

U-Module Dehumidifier 1.1

Activation dehumidifier in normal mode (r.H. in %)

Activation dehumidifier in reduced mode (r.H. in %)

Dewpoint - limit for dehumidifier activation in normal mode (C)

Dewpoint - limit for dehumidifier activation in reduced mode (C)

Weekly program

Confirm

Fig. 08-22 Webpage: Dehumidifier settings

The naming of the dehumidifiers is:

U-Module	Dehumidifier	1	1
Device to which dehumidifier is connected		Adress of U-Module	1st or 2nd dehumidifier on U-Module



Please note:

The pre-defined settings for reduced mode were chosen so, that during this phase dehumidifiers should not run under normal conditions. The idea behind that is to avoid noise pollution during the night.

If noise is not a problem, the settings for reduced mode should be modified or the weekly program should be deactivated (see U-Module Dehumidifier 2.1).

Diagnosis / calibration

◀ **Diagnosis/Calibration**

- System statistics
- Configuration overview
- State of inputs/outputs
- Probe calibration

Fig. 08-23 Webpage: Diagnosis / Calibration

Configuration overview

◀ **Configuration overview**

No. of CC	<input type="text" value="1"/>
No. of R-Modules	<input type="text" value="1"/>
No. of rooms	<input type="text" value="4"/>
No. of U-Modules	<input type="text" value="2"/>
No. of mixed circuit	<input type="text" value="1"/>
No. of dehumidifiers	<input type="text" value="2"/>

Confirm

Fig. 08-24 Webpage: Configuration overview

State of inputs / outputs

◀ **State of inputs/outputs**

Master

- Digital output 1 : 0
- Digital output 2 : 0
- Digital output 3 : 0
- Digital output 4 : 0
- Digital output 5 : 0
- Digital output 6 : 0
- Digital input 1 : 1
- Digital input 2 : 0
- Digital input 3 : 1
- Digital input 4 : 0
- Digital input 5 : 1

U-Module 0

- Digital output 1 : 0
- Digital output 2 : 0
- Digital output 3 : 0
- Digital output 4 : 0
- Digital input 1 : 1
- Digital input 2 : 0
- Digital input 3 : 0
- Digital input 4 : 0
- AO 1 : 0

Fig. 08-25 Webpage: Sate of Inputs/Outputs

Probe calibration

◀ **Probe calibration**

Living room

- Offset temp. probe
- Offset remote temp. probe
- Offset humidity probe

Hall

- Offset temp. probe
- Offset humidity probe

Kitchen

- Offset temp. probe
- Offset remote temp. probe
- Offset humidity probe

Bath

- Offset temp. probe
- Offset humidity probe

Confirm

Fig. 08-26 Webpage: Probe calibration

08.03 Operating by REHAU SMART 2.0 App

08.03.01 Installation of the App

The NEA SMART 2.0 App can be downloaded from the google® play store and apple® app store.

DEMO Mode

The APP features a DEMO mode. This mode can be accessed by pushing the "DEMO MODUS" button at the bottom part of the start screen.

To leave DEMO mode, go to "More" and then to "Account Management" and push "Log Off".

08.03.02 Setting up the App

There are two steps necessary to set up the App once it has been downloaded:

1. Create User Account
2. Pair your NEA SMART 2.0 installation to the App

The necessary steps are shown in the figures below.



Please make sure that the NEA SMART 2.0 installation is connected to internet.

Step 1:

After opening the App, the start screen appears. A personal account must be set up under the "Create account" menu item.

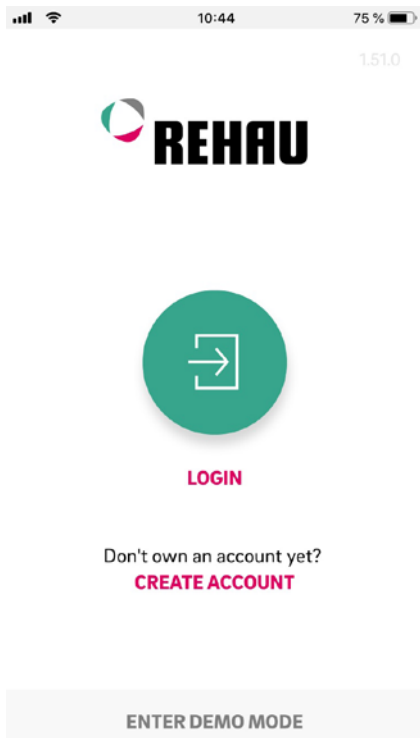

Fig. 08-27 App: Login page

Step 2:

You are required to enter your name, email address and specify a password. The password must be at least 10 characters long, contain at least one uppercase and one lowercase letter, a number and a special character.

Then confirm.

Once the "Sign up" field has been confirmed, an email is sent to the specified address, for verification. The "Terms and conditions" are confirmed by checking the box. You can read through the "Terms and conditions" by clicking the text highlighted in red.



Fig. 08-28 App: Create Account

Step 3:

Upon successful completion of the registration, the base station must be registered with the App. There are two ways to do this:

1. Scanning the QR code that is printed on the base station.
2. Entering the identification number and confirming.

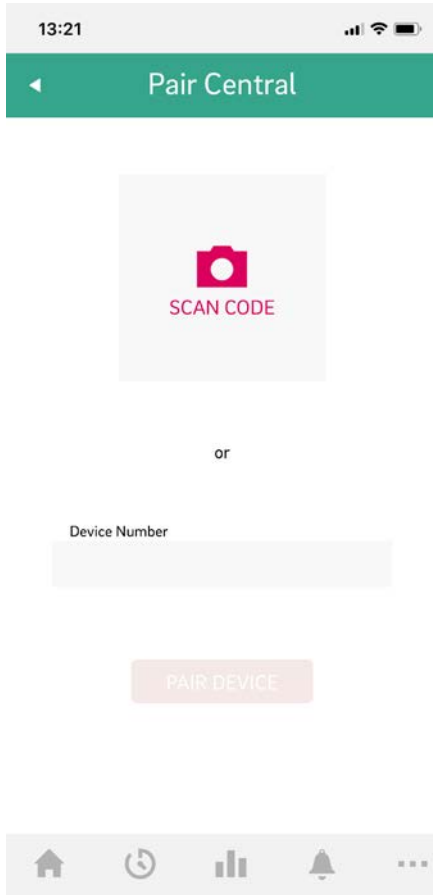

Fig. 08-29 App: Scan code on the base

Step 4:

Confirm by briefly pressing the OK button.

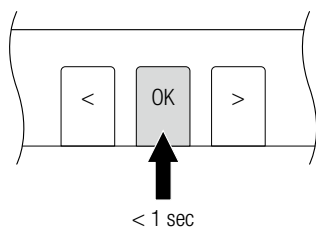

Fig. 08-30 App: Confirm

Step 5:

The overview screen of the App opens, and the individual rooms are displayed. The App can now be used.

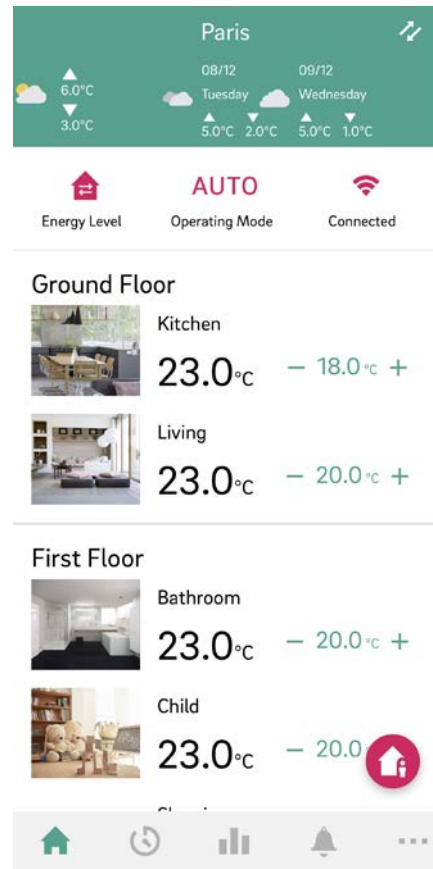

Fig. 08-31 App: Overview rooms

08.03.03 Getting to know the App

After successful pairing of App and NEA SMART 2.0 installation, the app will show the start screen with all the rooms of you installation.

The main navigation bar at the bottom of the screen guides you through the four main areas of the app:

- Home
- Timing programs
- Statistics
- Messages
- More

Home:

- The Home screen displays (from top to bottom)
 - Name of the Installation
 - Current weather and weather forecast
 - Information on current energy level, operating mode and WiFi connection
 - Overview of all rooms
 - Main navigation bar

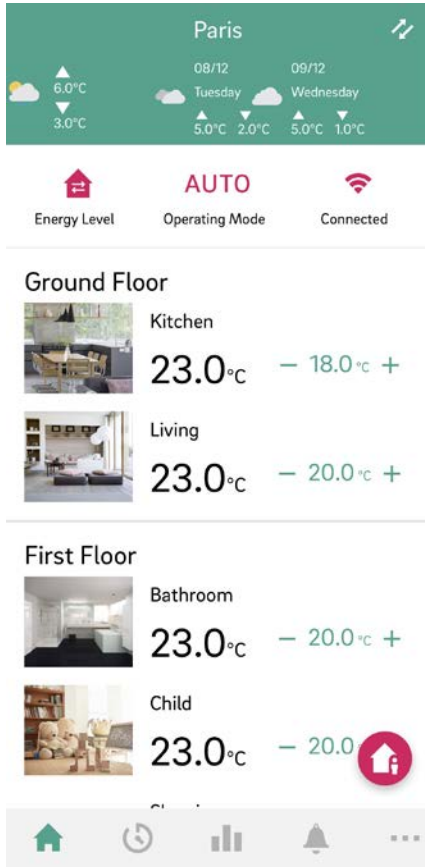

Fig. 08-32 App: Homescreen

Timing programs

The Timing program screen displays (from top to bottom)

- Daily/ weekly program, vacation/ party
- Main navigation bar

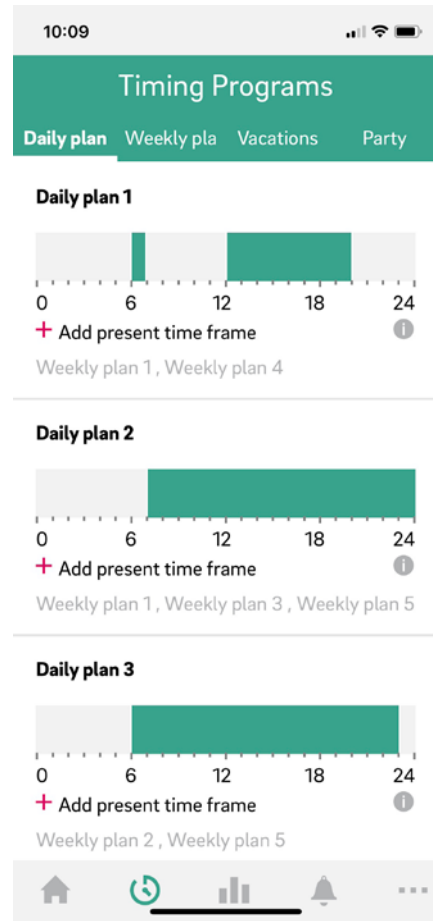

Fig. 08-33 App: Timing programs screen

Diagnostics

The Diagnostics screen displays (from top to bottom)

- Position of users (if activated)
- Different tiles to display statistics and information
- Main navigation bar

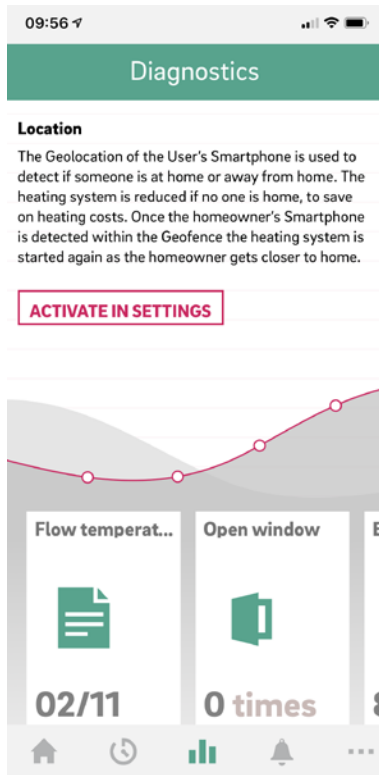

Fig. 08-34 App: Diagnostics screen

Messages

The Messages page shows alarms, warnings and general information about system events. The messages can be filtered, e.g. so that only new messages are displayed.

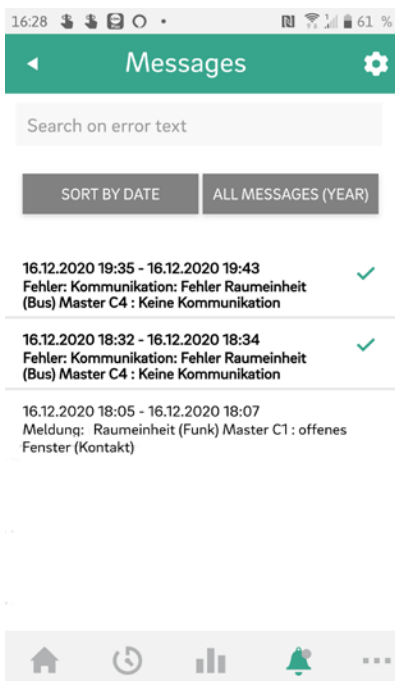

Fig. 08-35 App: Message screen

More

The More screen displays (from top to bottom):

- Account Management
- Settings
- Rooms/ Zones
- Message Management
- Legal
- Help
- Explore REHAU
- Icon to change between installations (only if more than one installation is linked to the account)
- Main navigation bar

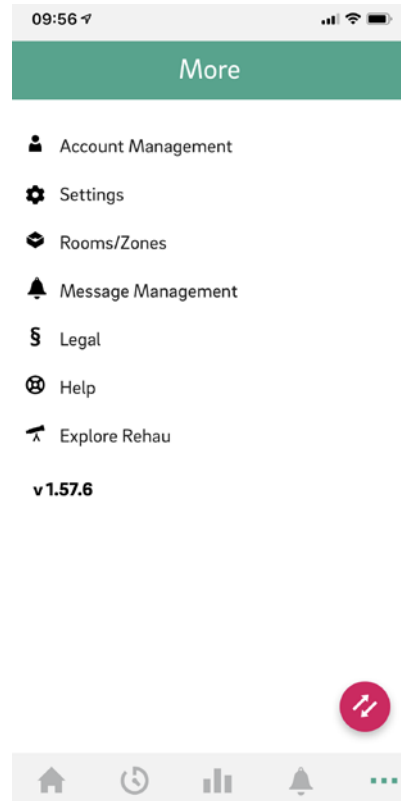

Fig. 08-36 App: More screen

08.03.04 First steps in the App

Set location

In order to receive the weather data for the location where the installation is located, the location must be set. For this purpose, the installation for which the location is to be set must be selected under More → Account Management → Buildings / Apartments.

If the location function of the used smart device is activated, you can click on the magenta-colored box. Then the current location of the used device is entered. You can also enter the location manually in the pre-defined lines. At the end, the entry must be confirmed on the bottom of the page.

Personalize rooms

Each room can be personalized with an own name and an individual picture or icon.

The rooms will be named Master-1, Master-2 and so on unless they have been given names already during the set up on the web page of the NEA SMART 2.0 installation.

To change the name of the room, choose the room in the main screen. The main room screen will be displayed:

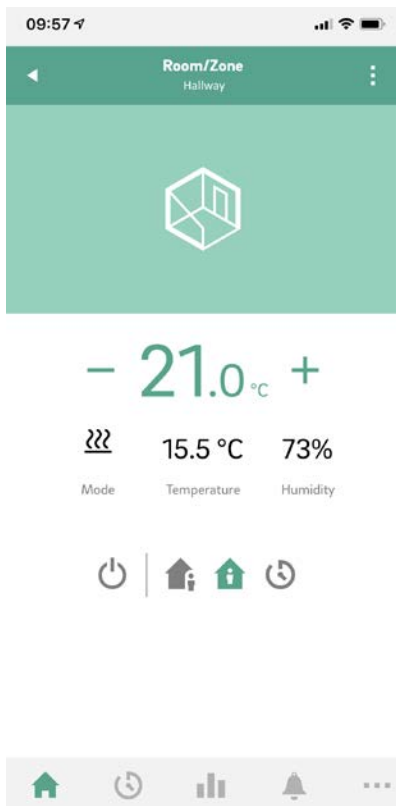

Fig. 08-37 App: Main room screen

Push the three dots on the upper right part of the screen and choose "Settings" and then "General" to get to the screen to change name and picture of the room.

Create zones and include rooms In some cases, several rooms may be put into one zone, e.g. main floor and first floor. To do so, got to "More" in the main screen, then chose "Rooms/Zone". New zones can be created after pushing the "Plus" icon. Rooms can be added to a zone once the new zone is created

Choose Energy Level for rooms

Rooms can have the following energy levels:

- Timed mode: rooms will follow the timing programs assigned to this rooms and will switch automatically between normal and reduced mode
- Normal mode: rooms will follow the set point that has been set for normal mode
- Reduced mode: rooms will follow the set point that has been set for reduced mode
- Standby: Rooms will not follow any set point. Only frost protection is active and rooms will be heated, once their temperature drop below 7 °C
- Vacation: Rooms will follow the set point that has been given for vacation.
- Party: Room will follow the set point for normal mode for the time chosen for party mode.

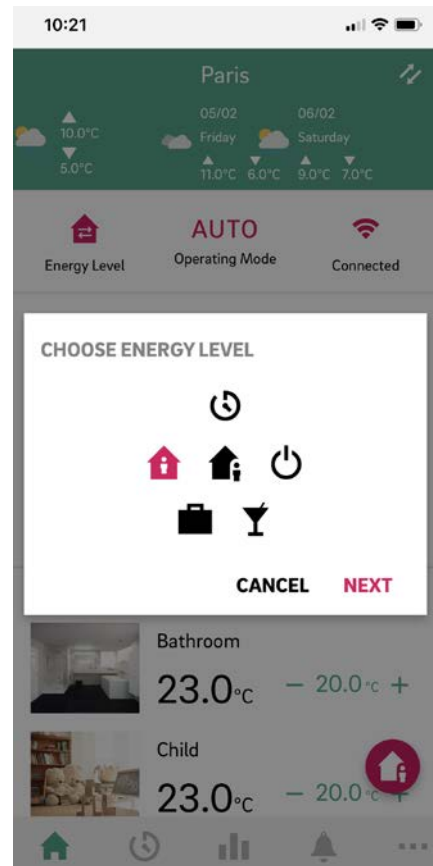

Fig. 08-38 App: Energy levels for rooms

The different levels can be assigned to the rooms either:

- In the main screen by pushing the Energy Level button
- Inside the main rooms screens

Choose set points for temperature in timed mode

For each room, there can be a set point defined for normal mode and reduced mode. To change these set points, choose the individual room in the start screen, push the three dots on the upper right part of the screen and choose "Settings" and then "Set points Room Temperature". In this screen, the set points can be adjusted.

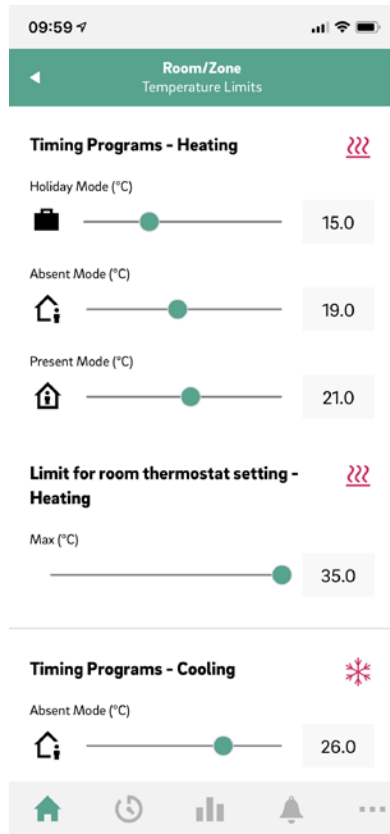

Fig. 08-39 App: Adjustment of set points

Define timing programs

NEA SMART 2.0 offers the option of creating five different weekly programs. These weekly programs can be combined from ten different daily programs. Each room can get assigned:

- One of the five weekly programs
- An even more customized timing program where every room has its individual day-by-day program.

To define the daily programs, go to "Timing programs" in the main menu bar. The daily plans are shown and can be adjusted. The option "Weekly Program" gives the possibility to combine the daily programs to a weekly program. The weekly program can be assigned to individual rooms when pushing the "+" button at the bottom of the "Weekly program" screens.

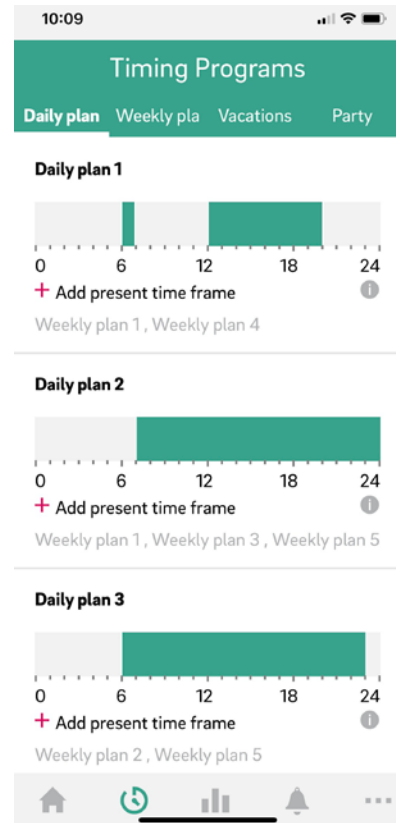

Fig. 08-40 App: Setting daily programs

Choose Operating Mode

The operating mode is valid for the complete NEA SMART 2.0 installation. There are five different choices:

- **Auto:** NEA SMART 2.0 changes automatically between heating, cooling or passive operating mode depending on outside conditions, rooms conditions and heating/cooling periods (if defined).
- **Heating:** NEA SMART 2.0 will heat only, depending on the room conditions, outside conditions and heating period (if defined).
- **Manual Heating:** NEA SMART 2.0 will heat depending on the room conditions, regardless of any heating period or outside condition.
- **Cooling:** NEA SMART 2.0 will cool only, depending on the room conditions, outside conditions and cooling period (if defined).
- **Manual Cooling:** NEA SMART 2.0 will cool depending on the room conditions, regardless of the cooling period and outside condition



Auto Mode and Cooling/ Cooling Manual is only available if your NEA SMART 2.0 system is configured for cooling. The heating and cooling modes can also be enabled or disabled depending on the control signals applied to the system.

08.03.05 Smart function Geofencing

The Geolocation function of the User's Smartphone is used to detect if someone is at home or away from home. To use the function, the position of the installation must be known. For this purpose, the installation for which the location is to be set must be selected under More → Account Management → Buildings / Apartments. If the location function of the used smart device is activated, the location button can be clicked. This can be found next to the address line. The current location of the used device is entered.

The heating system is reduced if no one is home, to save on heating costs. Once the homeowner's Smartphone is detected within the Geofence the heating system is started again as the homeowner gets closer to home.

Geofencing is a useful function if all home users have a smart phone and usually carry it with them when they leave home. It only works for rooms that are in timed mode. If the room is in timed mode "Normal" and no one is at home, the room will be switched to Reduced mode.

Geofencing should not be activated on tablets that stay at home.

08.03.06 Account Management

The first person, except an installer, that pairs the NEA SMART 2.0 installation to the App is the manager of the system. The manager can invite more people to access the installation via the app. To do so, go to More → Account Management → Buildings & Apartments. In the upper right part of the screen you can access the menu "Manage Users".

Above the line shown on the screen, all users are visible that belong to the family and have access to the installation. Below the line, installers with access to the installation are shown. The manager can invite new persons or delete them from the installation

08.03.07 Useful tips

Display weather data for the location of the installation

In order to display the weather data for the location of your installation, the location must be stored. To do this, go to the following page of your APP:

More → Account management → Buildings / Apartments → Installation xy

and select your installation.

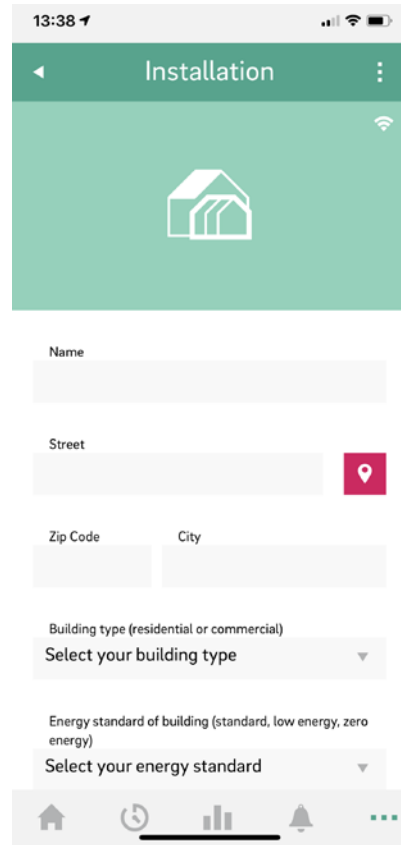

Fig. 08-41 App: Location of installation

Please press the magenta location button



to have your current location entered automatically. This ensures that the correct position is adopted. Then confirm the entries with Save at the end of the page.

Automatic update of the NEA SMART 2.0 APP (OTA)

In order to have the latest version of the app on your devices always, we recommend activating the button for automatic updates (OTA).

You can find this under:
More → Settings → General

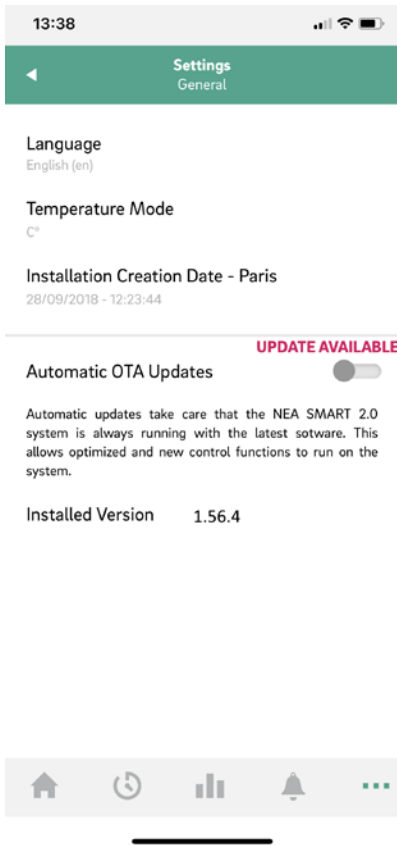

Fig. 08-42 App: Activating OTA

Update the display of the NEA SMART 2.0 App

It can happen that the app does not display the latest data from the Room units etc. A quick and easy update is necessary to bring the app up to date. To do this, pull the green weather bar from top to bottom, the app will then update automatically. A confirmation will be displayed at the end.

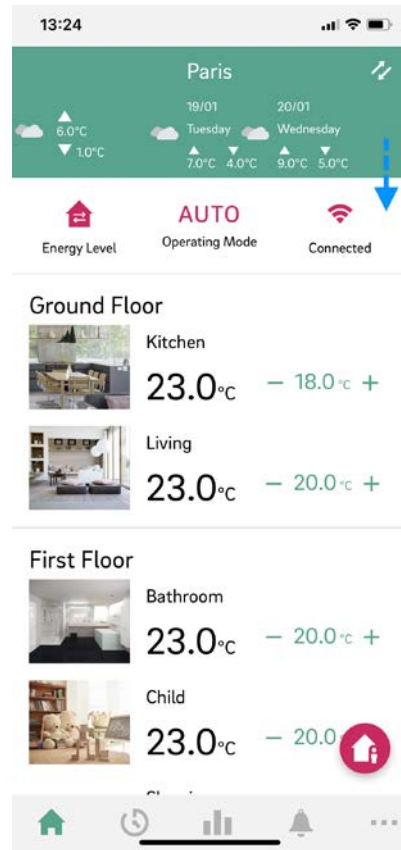

Fig. 08-43 App: update – drag it down

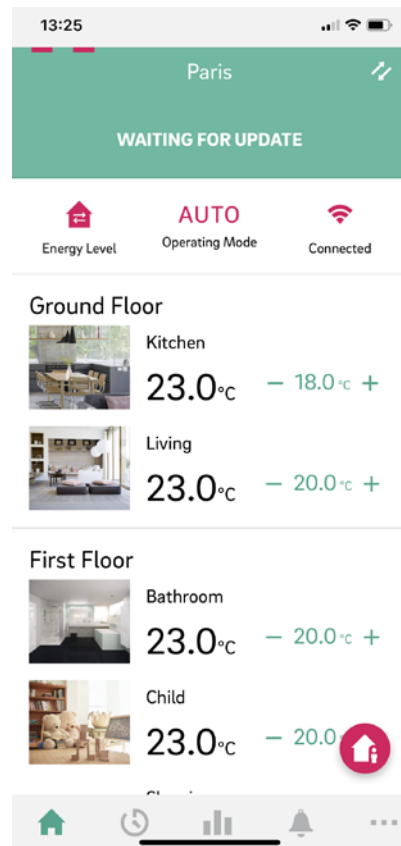

Fig. 08-44 App: update – waiting for update

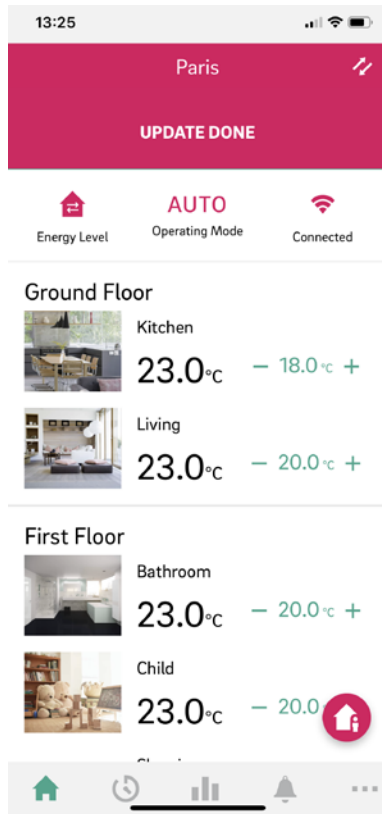

Fig. 08-45 App: update – successfully completed

08.04 FAQ's and troubleshooting

08.04.01 Problems and potential causes

The room doesn't get warm enough:

- Setpoint is set too low
- Room is in reduced mode
- An open window has been detected, so the heating is temporarily stopped or in reduced mode
- The battery of the room unit is empty, so no data/ commands can be sent to the base
- In the BUS version, the power supply may be interrupted, there is no contact to the base
- The heating system is not in heating mode or switched off
- Other cause that can be fixed only by your installer

The room is too warm

- Setpoint is too high, therefore the system continues to heat up

The room unit does not react to key presses

- Battery is empty. Please replace the batteries
- Room unit is defective, please contact your installer
- In the BUS version, the power supply may be interrupted, please contact your installer

A radio wave is displayed on the controller

- The room unit has lost connection to the base. Please have your installer clarify the cause. The use of an additional antenna may be necessary.

A window icon appears on the display

- An open window or a rapid temperature drop was detected in the room. In order to save energy, the heating of the room is reduced.

Drops are displayed on the display

- The humidity in the room is very high. There is a risk that condensation will occur on cold surfaces. Please note: If this happens more often, there is a risk of mould.

E01 ... E10 or E99 is displayed on the Room unit

- This is an error code, please check the error list and contact the installer if necessary...

08.04.02 Error-codes on NEA SMART 2.0 Room Units

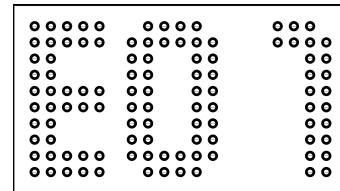

The following error messages can be displayed on the display of the room controller.

Please contact your installer to solve the problem:

- E 01 Room temperature sensor outside measuring range
- E 02 Room temperature sensor defective (interruption)
- E 03 Room temperature sensor defective (short circuit)
- E 04 Humidity outside the measuring range
- E 05 Humidity sensor defective (interruption)
- E 06 Humidity sensor defective (short circuit)
- E 07 Remote temperature sensor outside measuring range
- E 08 Remote sensor defective (interruption), check cable
- E 09 Short-circuit of remote sensor, check supply line
- E 10 Connection error between base and R-/U-Module
- E 90 Communication error between Base and several R-Modules
- E 99 Indication of a message that is displayed only on the NEA SMART App

08.04.03 Change batteries of Room Units and Probes

If you have opted for a radio-controlled system, you will see the battery status of the individual room units the NEA SMART 2.0 App.

When the battery life comes to an end, you will be notified, and you should replace the batteries.

Please use two AAA 1.5 V Micro LR03 batteries.

The BUS room units display a power plug instead of a battery symbol. There are no batteries to be changed.

If the "battery weak" message occurs, the batteries must be changed.

To do this, open the housing of the NEA SMART 2.0 Room Unit with a screwdriver (recommended width: 5 mm).

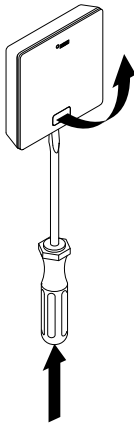

Fig. 08-46 Opening the NEA SMART 2.0 Room Unit

Remove the batteries from the holder and insert new batteries (type AAA). Observe polarity! See imprint on the board.

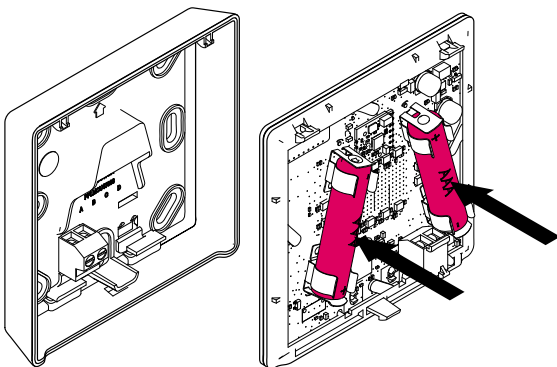

Fig. 08-47 NEA SMART 2.0 Room Unit battery change

Then close the front panel again.

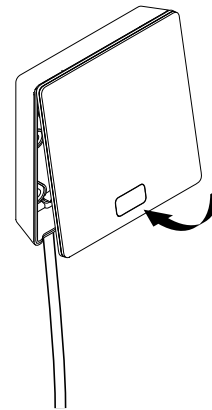

Fig. 08-48 NEA SMART 2.0 Room Unit: Close front panel



Depending on the installation place and the use of the room units, a battery change of the radio-operated room units is necessary approximately every 2 years. The upcoming battery change is indicated by a symbol on the display of the room unit as well as an icon in the NEA SMART 2.0 App.

09 Parameter

This chapter describes all parameters that can be set. There are two ways to access the parameter:

- 1 - Installer area of the webpage
- 2 - NEA SMART 2.0 App

The web page shows the most important parameters whereas the App gives access to all parameters.

However, only installers can access the parameters. Access to the parameters on the webpage is protected by a password. Access to the parameters inside the app is only given if the user is registered as an installer.

Please contact your local sales team for more information.

09.01 Heating general



To find in App:

Home → More → Settings → Installer → Control Parameters → Heating → General Parameters

Key	Text in parameter menu	Comment	Min	Max	Base value	Unit
HG1	Heating limit normal mode	When the timely filtered outside temperature undercuts this value, the heatmode starts. Applies to normal mode (not absence mode).	5	25	15	° C
HG2	Heating limit absence mode	Like HG1, but in absence mode.	5	25	13	° C
HG3	Hysteresis for start/stop heat mode	Value, by which the value of heatinglimit has to be undercut or exceeded to start or stop the heating mode.	0.1	5	0.5	K
HG4	Freeze protection supply temperature	Flow temperature for the freeze protection mode (building protection).	5	40	7	° C
HG5	Outside temperature limit for reduced mode	The reduced mode defined in the timing programs will not be executed when the outside temperature is below this value. By this a to slow heating up of the building is avoided.	-30	15	-10	° C

Tab. 09-1 Parameter heating general

09.01.01 Heating circuits

The parameters are used as

- Default values if a mixed circuit is specified during the configuration
- Reference values during supply of heating system (e.g. ceiling) via a heating circuit, which was parameterized for different system (e.g. floor)

Application:

Building is equipped with floor heating, only one or a few rooms have ceiling heating and are supplied by the same circuit)

The for each heating circuit (1-5) individual parameterisation of the flow temperature can be found in this parameter area.



To find in App:

Home → More → Settings → Installer → Control Parameters → Heating → Heating Circuits

During the start-up, a parameter set is created for each heating circuit in line with the utilisation of the heating circuit (floor/wall, ceiling, BKT).

The following additional parameters are specified individually for each circuit:

Legend for Base value:

0 : Floor

1 : Wall

2 : Ceiling

Key	Text in parameter menu	Comment	Min	Max	Base value	Unit
MIXH01	Heat curve starting point normal mode	The heat curve starts at this point, the value for the flow temperature is equal to the outside temperature here. Valid for normal mode (not absence mode).	10	40	0 : 20 1 : 20 2 : 20	° C
MIXH02	Heat curve starting point absence mode	Like MIXH01, but for absence mode.	10	40	0 : 17 1 : 16 2 : 16	° C
MIXH03	Heat curve slope in normal mode	Defines the slope of the heating curve. Valid for normal mode (not absence mode).	0	5	0 : 0.6 1 : 0.5 2 : 0.5	
MIXH04	Heat curve slope in absence mode	Like MIXH03, but for absence mode.	0	5	0 : 0.5 1 : 0.4 2 : 0.4	
MIXH05	Minimum value of supply temperature in heating mode (normal)	Minimum value for flow temperature at start of heating mode, independent from heat curve function. Valid for normal mode (not absence mode).	15	50	0 : 25 1 : 25 2 : 25	° C
MIXH06	Minimum value of supply temperature in heating mode (absence)	Like MIXH05, but for absence mode.	15	50	0 : 20 1 : 20 2 : 20	° C
MIXH07	Maximum value of supply temperature in heating mode (normal)	Maximum limit for flow temperature at very low outside temperatures, independent from heating curve function. Valid for normal mode (not absence mode).	20	70	0 : 45 1 : 40 2 : 40	° C
MIXH08	Maximum value of supply temperature in heating mode (absence)	Like MIXH07, but in absence mode.	20	70	0 : 40 1 : 35 2 : 35	° C
MIXH09	Filter time for outside temperature	For start and end of heating mode and for the calculation of flow temperature not the actual value of outside temperature, but the timely filtered value is used.	0	99	0 : 48 1 : 48 2 : 48	h

Key	Text in parameter menu	Comment	Min	Max	Base value	Unit
MIXHO10	Pilot room influence on heating limit	The average deviation of the pilot rooms affects, weighted with this parameter, the start/end of heating mode (shift of heating limit).	0	5	0 : 1 1 : 1 2 : 1	
MIXHO11	Flow temp. Reduction in reduced mode	In reduced mode (economy mode) the flow temperature is reduced by this value.	0	10	0 : 4 1 : 4 2 : 4	°C
MIXHO12	Compensation factor for room temperature	Influence of the deviation between set point and actual value of room temperatures on flow temperature.	0	5	0 : 1 1 : 1 2 : 1	
MIXHO13	Boost mode allowed	The boost mode function is allowed. Should be individual for each circuit.	0	1	0 : 1 1 : 1 2 : 1	

Tab. 09-2 Parameter heating circuits

09.01.02 Heating circuits, boost function



To find in App:

Home → More → Settings → Installer → Control Parameters → Heating → Boost Mode

Key	Text in parameter menu	Comment	Min	Max	Base value	Unit
BO01	Nominal slope reduction for return	The expected return temperature outside of the heating-up phase is a result of a re-calculation of the heating curve with a reduced slope. The percentual reduction of slope is set here.	10	70	40	%
BO02	Measure time for boost mode	The expected return temperature has to be undercut at least for this time span (see also BO03).	0	99	10	min
BO03	Hysteresis for boost mode	The expected return temperature has to be undercut at least for this value	0	4	1	K
BO04	Compensation factor for boost mode	The deviation to the expected return temperature multiplied with compensation factor gives the increase of the flow temperature (boost mode) for the time defined in BO05.	0	5	2	
BO05	Boost mode cycle time	Time period for the boost mode.	10	120	30	min
BO06	Boost mode pause time	Pause time after a cycle time in boost mode.	10	120	30	min

Tab. 09-3 Parameter heating circuits, boost mode

The function "Boost mode" is released separately for each heating circuit.

09.02 Heating circuits, boost function



To find in App:

Home → More → Settings → Installer → Control Parameters → Heating → General Parameters

Key	Text in parameter menu	Comment	Min	Max	Base value	Unit
C01	Cooling mode start delay time	Delay of start of cooling mode in minutes after cooling criterion is fulfilled.	0	1440	60	min
C02	Cooling mode minimum run time	Minimum run time of cooling mode after start in minutes.	0	1440	60	min
C03	Heating mode off-time after cool mode	Blocking time for heating mode, starting after end of cooling mode in hours.	0	96	12	h
C04	Calc. time for gradient reference room temp.	Cooling criterion: Time period for the calculation of temperature increase (or reduction) in reference room.	10	120	30	min
C05	Calc. time for average value ref. room temp.	Cooling criterion: Period for the calculation of average of reference room temperature.	10	120	30	min
C06	Factor deviation reference room temperat.	Cooling criterion: Weighting factor for the influence of reference room temperature.	0	10	2,5	
C07	Basic value f. current value of outside temp	Cooling criterion: Reference value for actual outside temperature (start cooling mode).	10	30	24	° C
C08	Basic value f. average value of outside temp	Cooling criterion: Reference value for the timely filtered outside temperature (start cooling mode).	10	30	18	° C
C09	Factor deviation of actual outside temp.	Cooling criterion: Weighting factor for the influence of actual outside temperature.	0	10	1.5	
C10	Factor deviation of average value out. temp	Cooling criterion: Weighting factor for the influence of the timely filtered outside temperature.	0	10	1.5	
C11	Reference room factor for gradient	Cooling criterion: Weighting factor for the influence of reference room temperature.	0	10	3	
C13	Summer compensation outside temp. start	Starting point of outside temperature, at which the room temperature set point is increased up to the in C13 defined value (at outside temperature C15).	24	32	30	° C
C14	Summer compensation outside temp. End	At this outside temperature the room temperature set point reaches the value defined in parameter C13. A further increase will not take place.	26	38	36	° C

Tab. 09-4 Parameter cooling general

09.02.01 Cooling circuits

Legend for Base value:

0 : Floor

1 : Wall

2 : Ceiling



To find in App:

Home → More → Settings → Installer → Control Parameters → Cooling → Cooling Circuits

Key	Text in parameter menu	Comment	Min	Max	Base value	Unit
CAn	Min.value supply temp. cooling mode (normal)	Minimum value of flow temperature in normal mode (not reduced mode).	8	25	0 : 16 1 : 16 2 : 16	°C
CBn	Flow temp. : safety distance to dew point	The flow temperature always has this safety distance to the worst (highest) value of the dew point temperature.	-5	10	0 : 2 1 : 2 2 : 2	K
CCn	Element temperature limit in cooling mode	The temperatue of cooled elements must not be below this value in cooling mode.	15	25	0 : 20 1 : 20 2 : 20	°C
CDn	Return temperature limit in cooling mode	The return temperatur must not be below this value in cooling mode.	10	25	0 : 18 1 : 18 2 : 18	°C
CEn	Increase cooling flow temp. in reduced mode	In reduced mode (energy safe mode) the flow temperature will be increased by this value.	0	10	0 : 1 1 : 1 2 : 1	K

Tab. 09-5 Parameter cooling circuits

09.03 Mixing circuit control



To find in App:

Home → More → Settings → Installer → Control Parameters → Mixed Circuit Controls

Key	Text in parameter menu	Comment	Min	Max	Base value	Unit
MIXG1	Proportional band-width heating circuits	Proportional band of PI-Controller. Affects the strenght of the immediate reaction to temperature change. The wider the band, the weaker the reaction.	2	80	20	K
MIXG2	Proportional band-width heating circuits	Proportional band of PI-Controller. Affects the strenght of the immediate reaction to temperature change. The wider the band, the weaker the reaction.	2	80	10	K
MIXG3	Integral time mixed circuits	Integral time in secs of controller in heating- and cooling mode. Affects the reaction to permanent deviation to the set point. The longer the time, the slower the reaction. 0 means OFF.	0	999	60	sec
MIXG4	Minimum value control signal	Minimum value of control signal for the actuator of mixing circuit.	0	100	0	%
MIXG5	Maximum value control signal	Maximum value of control signal for the actuator of mixing circuit.	0	100	100	%
MIXG6	Delay time for enabling PI-Controller	Delay for enabling the PI-controller after activation of the heating circuit pump.	0	999	15	sec

Tab. 09-6 Parameter mixing circuit control

09.04 Room temperature control

Legend for Base value:

0 : Floor

1 : Wall

2 : Ceiling



To find in App:

Home → More → Settings → Installer → Control Parameters → Room Temperature Control

Key	Text in parameter menu	Comment	Min	Max	Base value	Unit
RO1(n)	Proportional band-width heating mode	Proportional band of room temperature control in heating mode. The proportional band affects the immediate reaction to temperature change. The bigger the band, the weaker the reaction.	0	10	0 : 4 1 : 2 2 : 2	K
RO2(n)	Proportional band-width cooling mode	Like RO1, but for cooling mode.	0	10	0 : 4 1 : 2 2 : 2	K
RO3(n)	Pulse period time room temperature control	Time period of the pulse width modulation signal used for room temperature control.	5	120	0 : 20 1 : 10 2 : 10	min
RO4(n)	Minimum pulse length room temp. Control	Pulses below this value will be restrained.	0	30	0 : 4 1 : 3 2 : 3	min
RO5(n)	Integral time room temperature control	Integral time in minutes of controller in heating- and cooling mode. Affects the reaction to permanent deviation to the set point. The longer the time, the slower the reaction. 0 means OFF.	0	600	0 : 180 1 : 90 2 : 90	min
RO6(n)	Integral part limitation	Limitation of integral part in control signal in %.	0	100	0 : 30 1 : 30 2 : 30	%
RO7(n)	Optimization room temperature control	Level of room temperature control optimization.	0	10	0 : 5 1 : 5 2 : 5	K
RO8(n)	Pulse length threshold for continuous mode	Pulses with a length above this limit (percentage of pulse width period) result in a permanent activation of drives (continuous signal).	50	100	0 : 80 1 : 80 2 : 80	%
RO9(n)	Shift of proportional band	Defines the middle position of p-band. 0% means symmetrical to set point. Can be reduced to -25% or more in case of well adjusted flow temperatures and well insulated buildings.	-50	50	0 : 0 1 : 0 2 : 0	%
R10	Room temperature for freeze protection	When the heating function is deactivated the heating starts below this room temperature.	3	15	5	°C

Tab. 09-7 Parameter room temperature control

09.05 Device control

09.05.01 Heater control



To find in App:

Home → More → Settings → Installer → Device → Heating Unit

Key	Text in parameter menu	Comment	Min	Max	Base value	Unit
DH1	Minimum demand time heating device	Minimum time the heating device gets started for in minutes.	0	20	1	min
HE2	Position of mixing valve for heating demand	The opening of mixing valve of mixed circuit has to exceed this value before the heating device is demanded. See also HE3.	0	100	50	%
HE3	Hysteresis of mixing valve position for heating demand signal	Symmetric hysteresis layed around the value HE2 for start and stop of demand signal.	0	25	5	%
DH4	Delay time heater demand signal	Pause time before demand signal for heating device.	0	10	1	min
DH5	Heater blocking time before restart	After end of operation of heating device the next demand signal will be soonest after this delay time.	0	15	3	min

Tab. 09-8 Parameter heater control

09.05.02 Chiller control



To find in App:

Home → More → Settings → Installer → Device → Cooling Unit

Key	Text in parameter menu	Comment	Min	Max	Base value	Unit
DC1	Minimum demand time for chiller	Minimum duration for the chiller demand signal.	0	20	1	min
DC2	Position of mixing valve for cooling demand	The opening of mixing valve of mixed circuit has to exceed this value before the chiller is demanded. See also DC3.	0	100	50	%
DC3	Hysteresis of mixing valve position for cooling demand signal	Symmetric hysteresis layed around the value DC2 for start and stop of demand signal.	0	25	5	%
DC4	Delay time for chiller demand signal	Pause time before demand signal for chiller.	0	10	1	min
DC5	Chiller blocking time before restart	After end of operation of chiller the next demand signal will be soonest after this delay time.	0	15	3	min

Tab. 09-9 Parameter chiller control

09.06 Dehumidifier control



To find in App:

Home → More → Settings → Installer → Device → Dehumidifier

Key	Text in parameter menu	Comment	Min	Max	Base value	Unit
DHAN	Activation dehumidifier in normal mode	When this value of relative humidity is exceeded, the dehumidifier is started during the enable time of his timing program.	30	90	55	%
DHRN	Activation dehumidifier in reduced mode	When this value of relative humidity is exceeded, the dehumidifier is started during the enable time of his timing program.	50	90	80	%
DE3	Hysteresis relative humidity	One-sided hysteresis around the switching threshold.	0	20	5	%
DE4	Dewpoint-Limit for the activation of dehumidifier	When this dew point value is exceeded the assigned dehumidifier will be started.	10	25	15	°C
DE5	Hysteresis dew point	One-sided hysteresis around the switching threshold (switch off point is by this value below DE4).	0	2	0,5	K
DE6	Minimum runtime dehumidifier	Minimum demand time for dehumidifier.	0	20	10	min
DE7	Blocking time before restart	After end of operation of dehumidifier the next demand signal will be soonest after this delay time.	0	20	10	min
DE8	Dehumidifying outside cooling mode allowed	Dehumidification is also allowed outside of cooling period (Y/N).	0	1	0	
DE9	Maximum runtime dehumidifier	Maximum run time for dehumidifier.	30	999	240	min
DE10	Dewpoint-Limit for the activation of dehumidifier in reduced mode	When this dew point value is exceeded the assigned dehumidifier will be started outside the enable time of his timing program.	10	25	17	°C

Tab. 09-10 Parameter dehumidifier control

09.07 Pump control



To find in App:

Home → More → Settings → Installer → Device → Pumps

Key	Text in parameter menu	Comment	Min	Max	Base value	Unit
PU1(n)	Pump local / global	Pump is used as local pump or as global pump (true = local).	0	1	1	
PU2(n)	Pump type	Pump type: high efficiency or standard (true = high efficiency).	0	1	1	
PU3(n)	Enable pump antiblock function (YES/NO)	Enable pump antiblock function (YES/NO).	0	1	0	
PU4	Pump antiblock function period	Pump antiblock function is activated after x days, when the pump has not been started.	1	200	90	d
PU5	Pump antiblock function start time	Pump antiblock function is started at this time (hours).	0	24	3	h
PU6	Pump antiblock function run time	Pump antiblock function is running for this time (minutes).	1	30	5	min
PU7(n)	Start delay of pump for mixed circuit	delay time for pump request, starting from the activation of the manifold valves.	0	15	4	min
PU8(n)	Overshoot time of pump for mixed circuit	Overrun time of pump, starting from the de-activation of the manifold valves.	0	15	1	min
PU9	Minimum run time of pump (standard)	Minimum run time of pump in minutes (standard version).	0	15	1	min
PU10	Minimum run time of pump (high efficiency)	Minimum run time of pump in minutes (high efficiency).	0	120	30	min
PU11	Minimum pause time of pump (standard)	Minimum pause time of pump in minutes (standard).	0	15	1	min
PU12	Minimum pause time of pump (high efficiency)	Minimum pause time of pump in minutes (high efficiency).	0	60	1	min

Tab. 09-11 Parameter pump control

09.08 Valve control

To find in App:

Home → More → Settings → Installer → Device → Valves

Key	Text in parameter menu	Comment	Min	Max	Base value	Unit
VA1	Enable valve antiblock function (YES/NO)	Enable valve antiblock function (YES/NO).	0	1	1	
VA2	Valve antiblock function period	Valve antiblock function is activated after x days, when the valve has not been opened.	1	200	90	
VA3	Valve antiblock function start time	Valve antiblock function is started at this time.	0	24	3	h
VA4	Valve antiblock function run time	Valve antiblock function is running for at this time (minutes).	1	30	5	min
VA5	Zone valves run time	Run time of the valves at the manifolds.	0	10	4	min
VA6	Switching valves run time	Run time of the switching valves for heating / cooling.	0	10	4	min

Tab. 09-12 Parameter Valve control

09.09 Eu.bac - Energy-optimized settings

For energy-optimized operation of the NEA SMART 2.0 control system, the following parameter have been changed compared to the standard values:

Application underfloor heating (Water Floor Heating System):

R01(0)	Proportional band in heating mode (K):	3.5 K
R05(0)	Integral time room temperature control (min):	150 min
R04(0)	Minimum pulse length room temperature control (min):	2 min

Application chilled ceiling (Ceiling System Cooling):

R05(2)	Integral time room temperature control (min):	60 min
R04(2)	Minimum pulse length room temperature control (min):	2 min
R09(2)	Shifting the proportional band (%):	-15 %

The CA values specified for the NEA SMART 2.0 control system (for underfloor heating application CA = 0.3 K, chilled ceiling application CA = 0.6 K) refer to these values.

Find inside the webpages:

Installer → Settings → Control parameter → Floor or → Ceiling

Find inside the app:

More → Settings → Installer → Control Parameter → Room temperature control

Application	for	CA value in K	License number
WATER FLOOR HEATING SYSTEM	NEA SMART 2.0 Base 230 V	0.3	220956
CEILING SYSTEM COOLING	NEA SMART 2.0 Base 230 V	0.6	220956
WATER FLOOR HEATING SYSTEM	NEA SMART 2.0 Base 24 V	0.3	20957
CEILING SYSTEM COOLING	NEA SMART 2.0 Base 24 V	0.6	20957

Tab. 09-13 License number Eu.bac

10 Data

10.01 Electrical termination

Solid cable	0.5 – 1.5 mm ²
Multiple stranded cable	1.0 – 1.5 mm ²

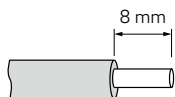

10.02 Factory settings

Some of the In- and Outputs of the NEA SMART 2.0 system are already predefined.

The definition of those In- and Outputs can be changed on the integrated Webpages of the system.

10.02.01 Base

Digital Outputs

Connection	Signal type	Pre-defined allocation	Possible allocation
RELAY 1	Switch	Pump Local	Pump local Pump global
RELAY 2	Switch	Boiler	Boiler Chiller
RELAY 3	Switch	Chiller	Dehumidifier valve Dehumidifier compressor Fan Coil
RELAY 4	Switch	-	Heating Cooling
RZ1-8	Switch	Valves room 1-8	

Digital Inputs

DI 1	-	-	Absence Open Window
DI 2	-	-	Alarm Heating
DI 3	-	-	Cooling Reduced local Reduced global
DI 4	-	-	Dew point

Tab. 10-1 Factory Settings and possible allocations Base

10.02.02 R-Module**Digital Outputs**

Connection	Signal type	Pre-defined allocation	Possible allocation
RELAY 1	Switch	-	Pump local Pump global
RELAY 2	Switch	-	Boiler Chiller Dehumidifier valve Dehumidifier compressor
RZ9-12	Switch	Valves room 9-12	Fan coil Heating Cooling

Digital Inputs

DI 1	-	-	Absence Open Window Alarm Heating Cooling Reduced local Reduced global Dew point
------	---	---	---

Tab. 10-2 Factory Settings and possible allocations R-Module

10.02.03 U-Module (Defined as Mixed circuit)**Digital Outputs**

Connection	Signal type	Pre-defined allocation	Possible allocation
RELAY 1	Switch	Pump mixed circuit	
RELAY 2	Switch	-	-
RELAY 3	Switch	-	-
RELAY 4	Switch	-	-

Digital Inputs

DI 1	-	Dew point sensor	-
DI 2	-	Requirement mixed circuit	-

Analogue Inputs

AI 1	NTC	Supply temperature	
AI 2	NTC	Return temperature	
AI 3	NTC	External temperature	-
AI 4	NTC	-	-

Analogue Outputs

0/10 V	0-10 V	Regulation signal mixing valve	
--------	--------	--------------------------------	--

Tab. 10-3 Factory Settings U-Module when defined as Mixed Circuit

10.02.04 U-Module (Defined for Dehumidifier)**Digital Outputs**

Connection	Signal type	Pre-defined allocation	Possible allocation
RELAY 1	Switch	Dehumidifier 1 valve	
RELAY 2	Switch	Dehumidifier 1 compressor	
RELAY 3	Switch	Dehumidifier 2 valve	
RELAY 4	Switch	Dehumidifier 2 compressor	

Digital Inputs

DI 1	-	-	
DI 2	-	-	
DI 3	-	-	
DI 4	-	-	

Analogue Inputs

AI 1	NTC	-	
AI 2	NTC	-	
AI 3	NTC	-	
AI 4	NTC	-	

Analogue Outputs

0/10 V	0-10 V	-	
--------	--------	---	--

Tab. 10-4 Factory Settings U-Module when defined for dehumidifier

10.02.05 U-Module (defined for Fan Coil)**Digital Outputs**

Connection	Signal type	Pre-defined allocation	Possible allocation
RELAY 1	Closer relay	Fan Coil 1	
RELAY 2	Closer relay	Fan Coil 2	
RELAY 3	Closer relay	Fan Coil 3	
RELAY 4	Closer relay	Fan Coil 4	

Digital Inputs

DI 1	-	-	
DI 2	-	-	
DI 3	-	-	
DI 4	-	-	

Analogue Inputs

AI 1	NTC	-	
AI 2	NTC	-	
AI 3	NTC	-	
AI 4	NTC	-	

Analogue Outputs

0/10 V	0-10 V	-	
--------	--------	---	--

Tab. 10-5 Factory setting U-Module, defined for fan coil

10.02.06 U-Module (defined for dehumidifiers and fan coil)**Digital Outputs**

Connection	Signal type	Pre-defined allocation	Possible allocation
RELAY 1	Closer relay	Fan Coil 1	
RELAY 2	Closer relay	Dehumidifier 1 compressor	
RELAY 3	Closer relay	Fan Coil 2	
RELAY 4	Closer relay	Dehumidifier 2 compressor	

Digital Inputs

DI 1	-	-	
DI 2	-	-	
DI 3	-	-	
DI 4	-	-	

Analogue Inputs

AI 1	NTC	-	
AI 2	NTC	-	
AI 3	NTC	-	
AI 4	NTC	-	

Analogue Outputs

0/10 V	0-10 V	-	
--------	--------	---	--

Tab. 10-6 Factory setting U-Module, defined for fan coil and dehumidifier

10.03 Allocation of the clamps

10.03.01 NEA SMART 2.0 Base 24 V

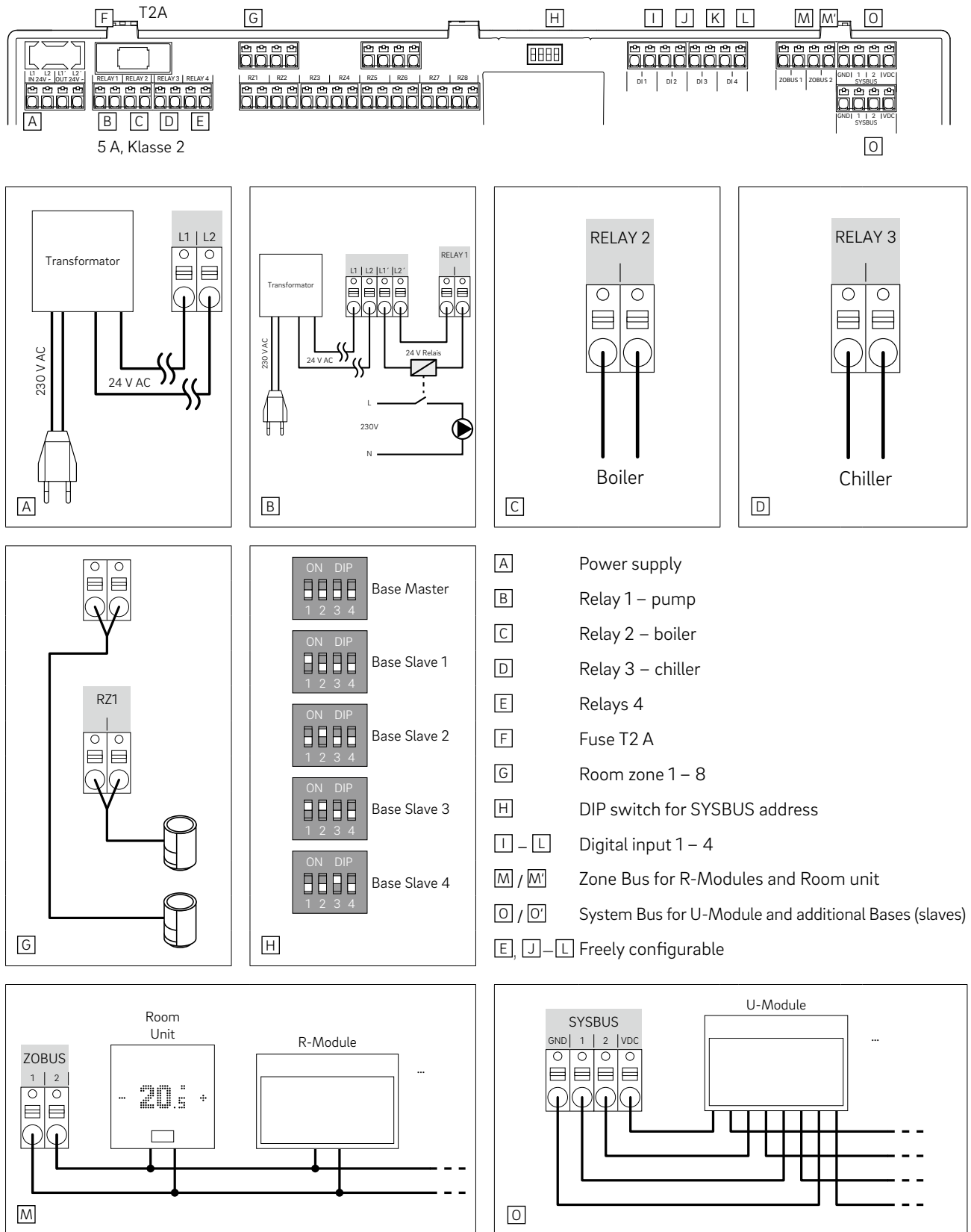

Fig. 10-1 Allocation of the clamps – NEA SMART 2.0 Base 24 V

10.03.02 NEA SMART 2.0 Base 230 V

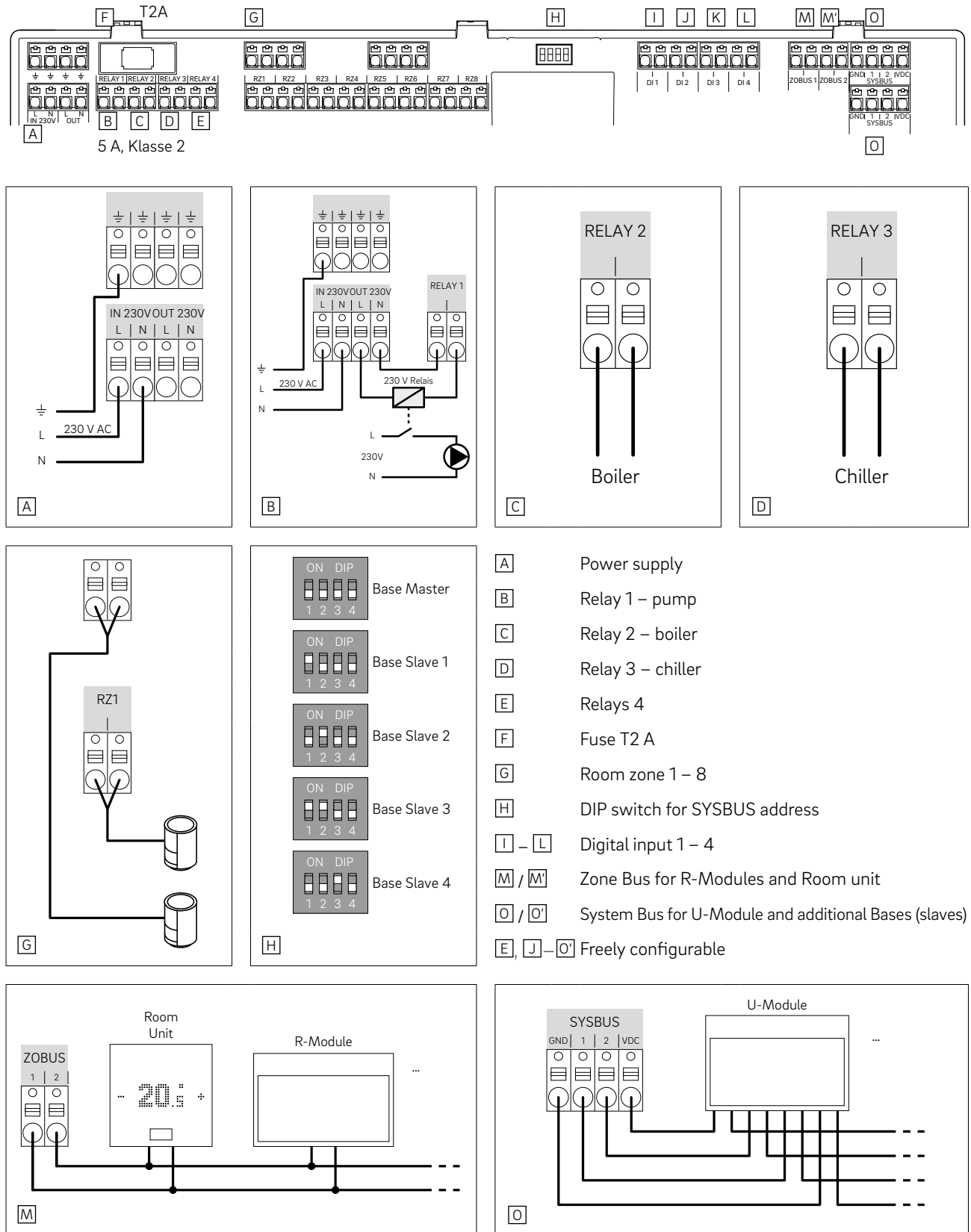
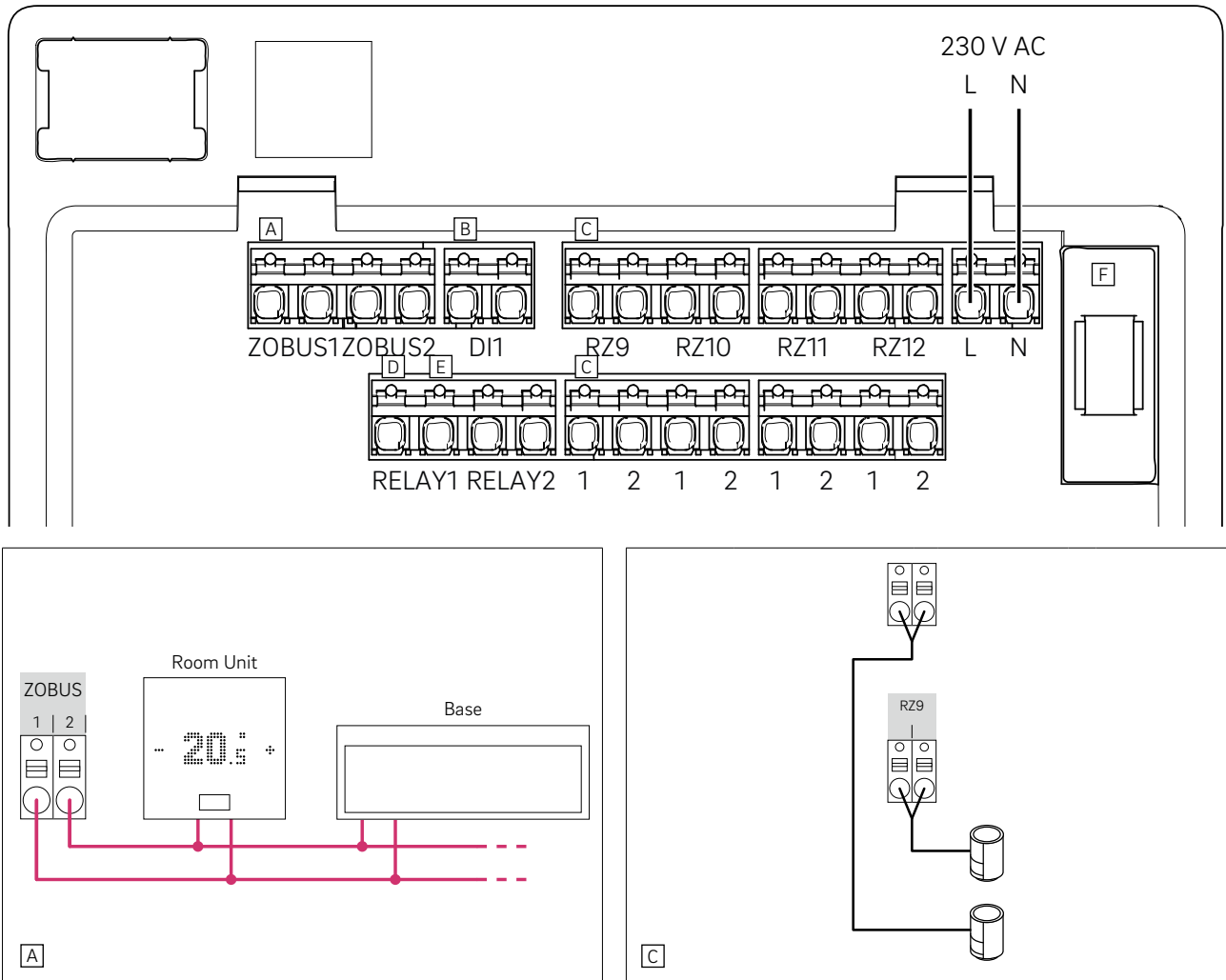

Fig. 10-2 Allocation of the clamps – NEA SMART 2.0 Base 230 V

10.03.03 NEA SMART 2.0 R-Module 230 V



- [A] Zone Bus
- [B] Digital Input 1
- [C] Zone 9 – 12
- [D] Relay 1, 5 A, Class 2
- [E] Relays 2, 5 A, Class 2
- [F] Fuse T2 A
- [B], [D]–[E] Freely configurable

Fig. 10-3 Allocation of the clamps - NEA SMART 2.0 R-Module 230 V

10.03.04 NEA SMART 2.0 R-Module 24 V

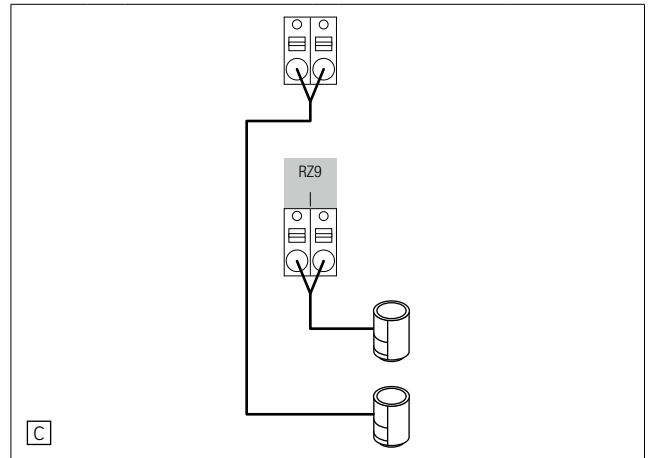
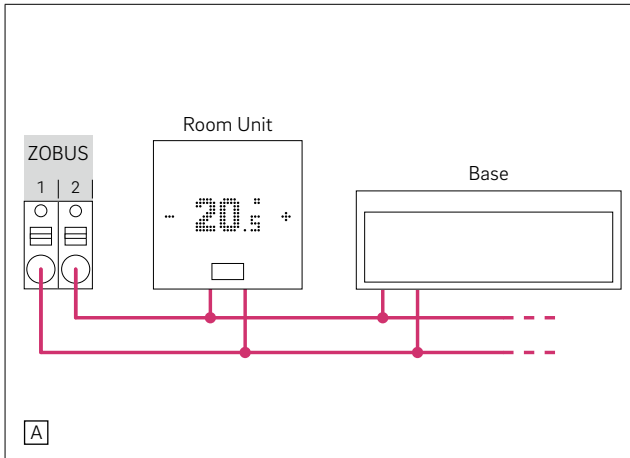
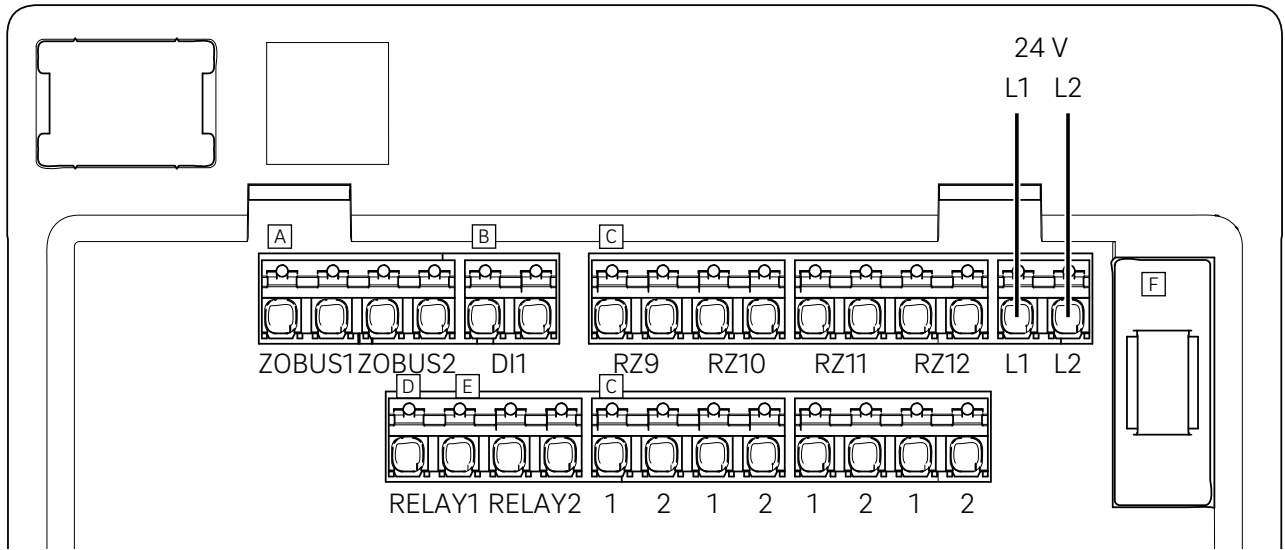

- [A] Zone Bus
- [B] Digital Input 1
- [C] Zone 9 – 12
- [D] Relay 1, 5 A, Class 2
- [E] Relays 2, 5 A, Class 2
- [F] Fuse T2 A
- [B], [D]–[E] Freely configurable

Fig. 10-4 Allocation of the clamps - NEA SMART 2.0 R-Module 24 V

10.03.05 NEA SMART 2.0 U-Module 24 V

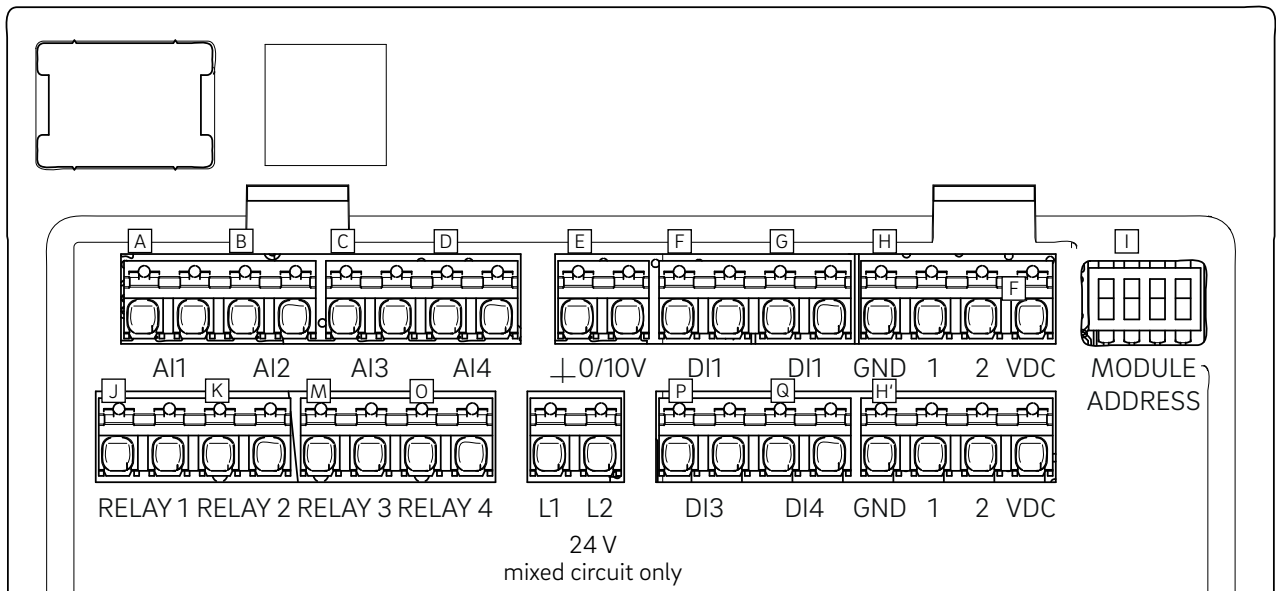

- A–D Analogous Input: 1 ... 3 NTC 10K
- E Analogous Output: 0 – 10 V
- F–G Digital Input 1 – 4
- P–Q
- H System Bus
- I DIP Switch for SYSBUS address
- J...O Relais 1 – 4, 5 A, Class 2

Fig. 10-5 Allocation of the clamps - NEA SMART 2.0 U-Module 24 V

10.03.06 NEA SMART 2.0 U-Module 24 V – Mixed Circuit

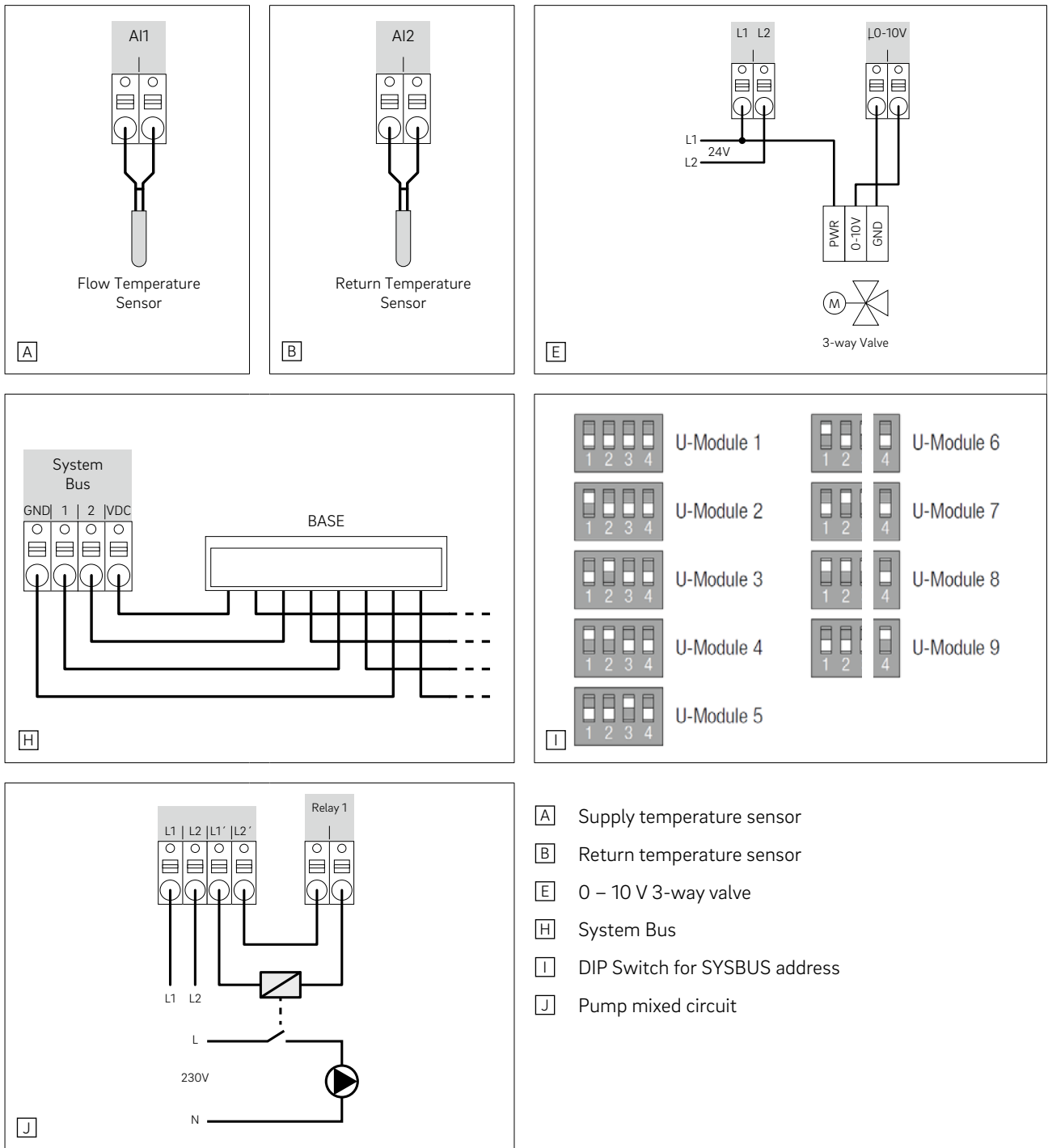

- [A] Supply temperature sensor
- [B] Return temperature sensor
- [E] 0 – 10 V 3-way valve
- [H] System Bus
- [I] DIP Switch for SYSBUS address
- [J] Pump mixed circuit

Fig. 10-6 Allocation of the clamps - NEA SMART 2.0 U-Module 24 V - Mixed circuit

10.03.07 NEA SMART 2.0 U-Module 24 V - Dehumidifier

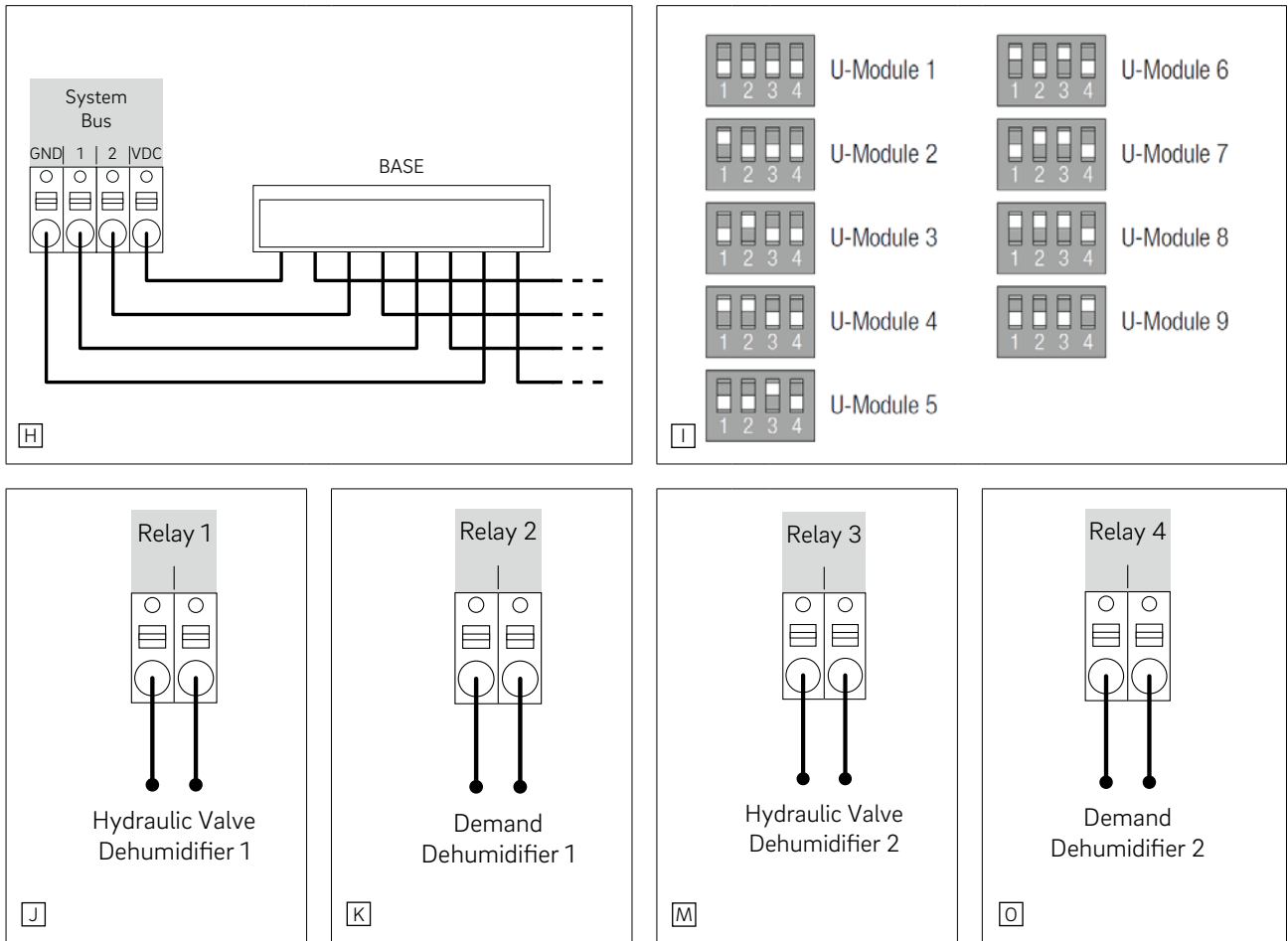

- [H] System Bus
- [I] DIP switch for SYSBUS address
- [J] Hydraulic valve dehumidifier 1
- [K] Compressor dehumidifier 1
- [M] Hydraulic valve dehumidifier 2
- [O] Compressor dehumidifier 2

Fig. 10-7 Allocation of the clamps - NEA SMART 2.0 U-Module 24 V - Dehumidifier

11 Scheme



The following schemes are based on the NEA SMART 2.0 components in 24 V version.

11.01 Overview

No	Description	Systemtype	Place	Base	R-Module	U-Module	Sensor Sets
1	Simple Room Temperature Control	Underfloor heating	House/ Apartment with single floor	1	-	-	-
2	Enlarged Room Temperature Control	Underfloor heating	House/ Apartment with two floors	1	1	-	-
3	Enlarged Room Temperature Control with chilled ceiling	Underfloor heating + chilled ceiling	House/ Apartment with single floor	1	1	-	-
4	Simple Room Temperature Control with mixed circuit	Underfloor heating and cooling	House/ Apartment with single floor	1	-	1	1
5	Simple Room Temperature Control with mixed circuit and two dehumidifiers	Underfloor heating and cooling	House/ Apartment with single floor	1	-	2 (1x mix. heating circuit + 1 x 2 dehumidifier)	2
6	Simple Room Temperature Control with mixed circuit	Underfloor heating and cooling	House/ Apartment with two floors	2	-	1	1
7	Room Temperature Control with chilled ceiling, mixed circuit and two dehumidifiers	Underfloor heating + chilled ceiling + dehumidifier	House/ Apartment with two floors	2	2	2	-
8	Simple Room Temperature Control with chilled ceiling, mixed circuit and dehumidifiers	Underfloor heating + chilled ceiling + dehumidifier	House with three floors	3	3	2	-
9	Large Room Temperature Control	Underfloor heating	Light Commercial	4	0	0	0

Tab. 11-1 Overview - Scheme

11.01.01 Simple Room Temperature Control

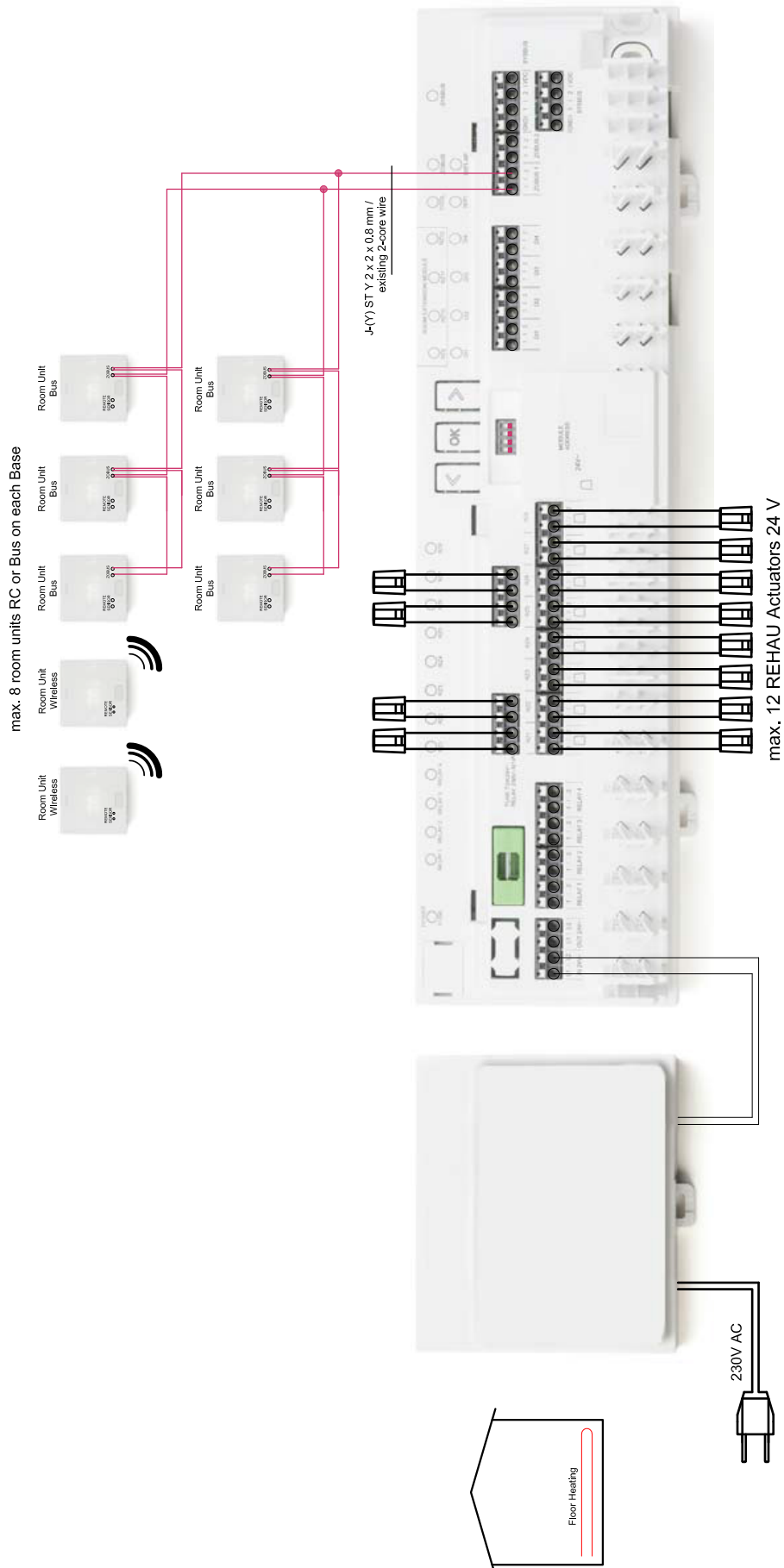

Fig. 11-1 Simple Room Temperature Control - Underfloor heating - House/ Apartment with single floor

11.01.03 Enlarged Room Temperature Control with chilled ceiling

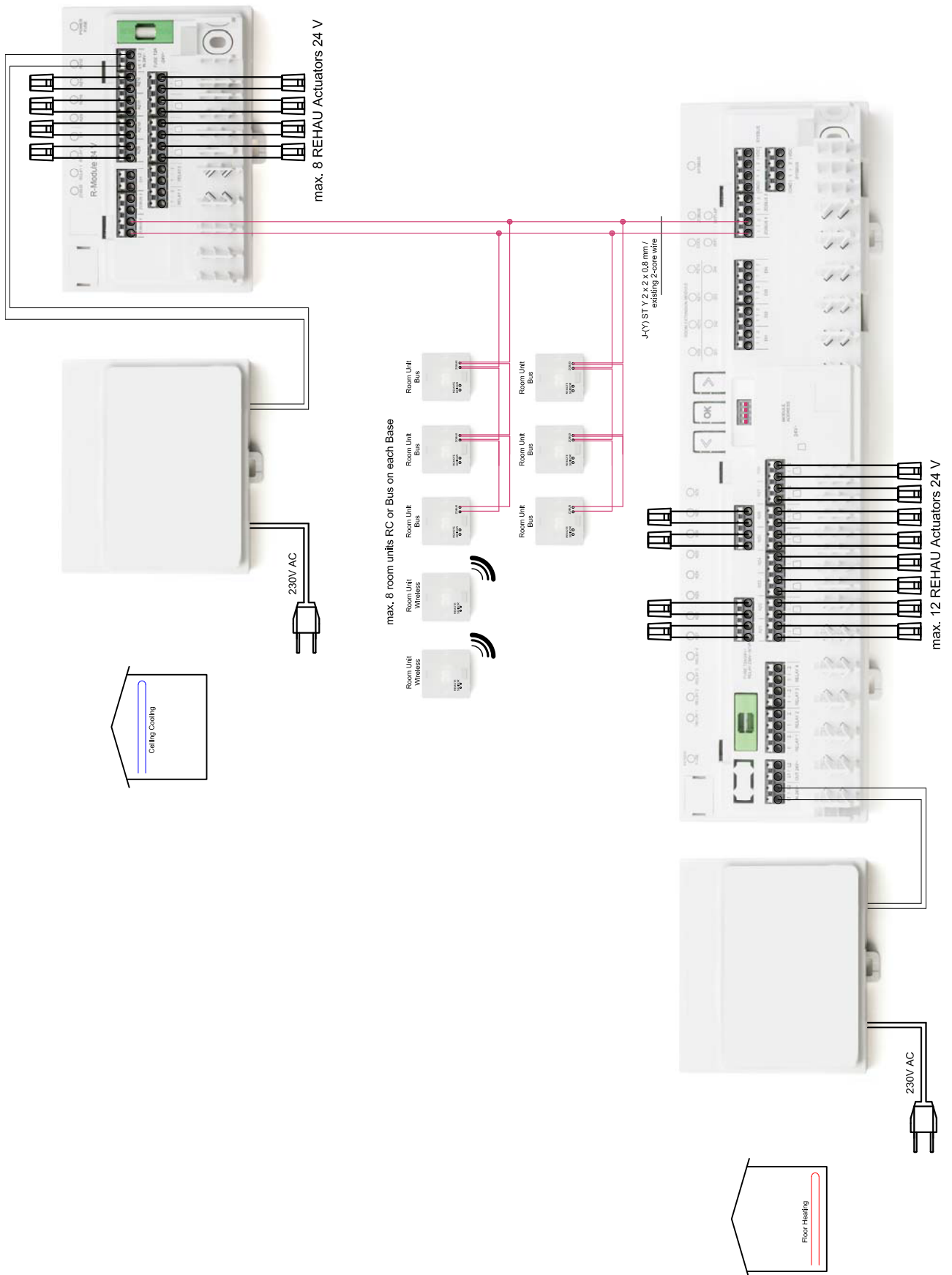

Fig. 11-3 Enlarged Room Temperature Control with chilled ceiling - Underfloor heating + chilled ceiling - House/ Apartment with single floor

11.01.05 Simple Room Temperature Control with mixed circuit and two dehumidifiers

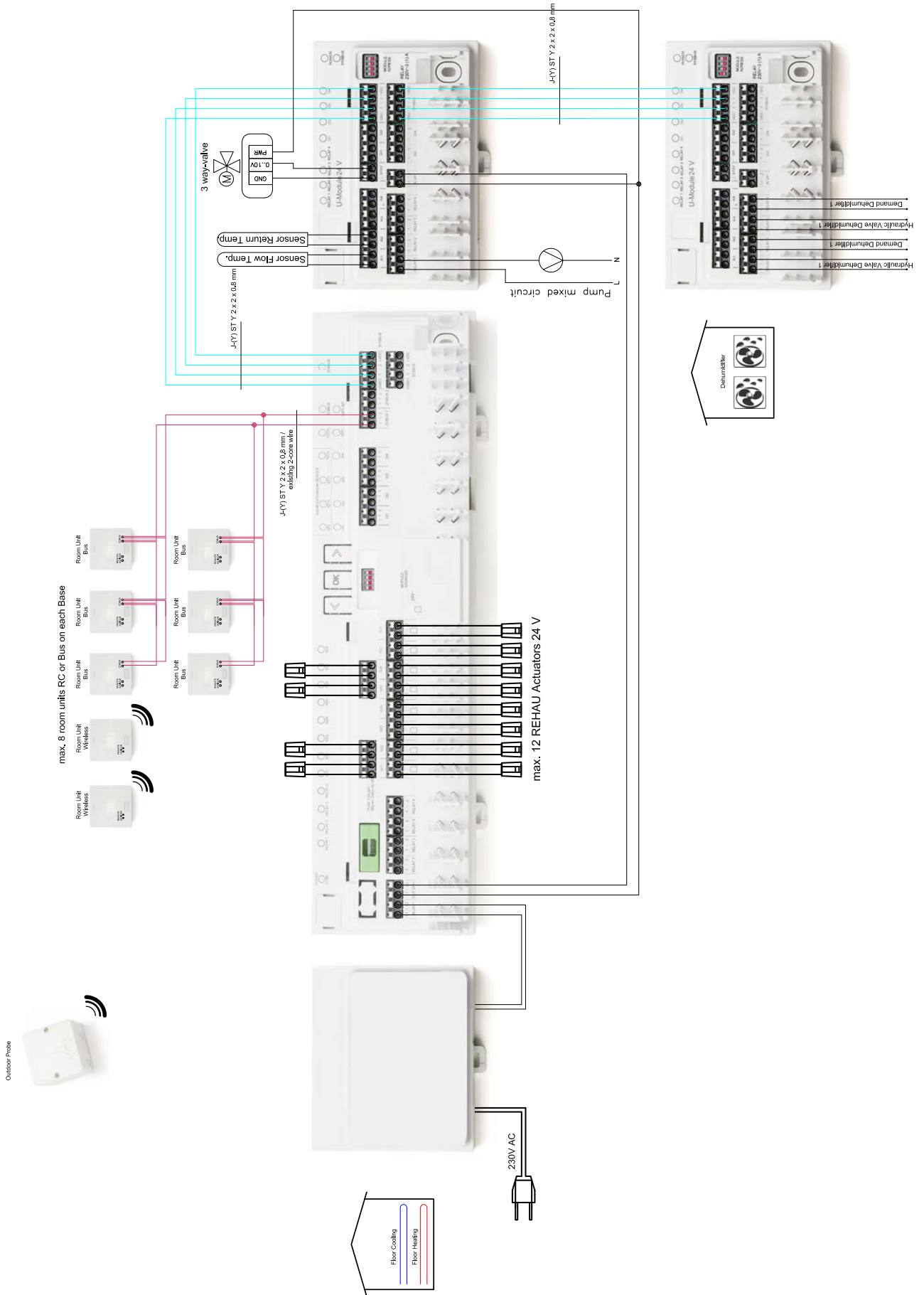

Fig. 11-5 Simple Room Temperature Control with mixed circuit and two dehumidifiers - Underfloor heating and cooling - House/ Apartment with single floor

11.01.06 Simple Room Temperature Control with mixed circuit

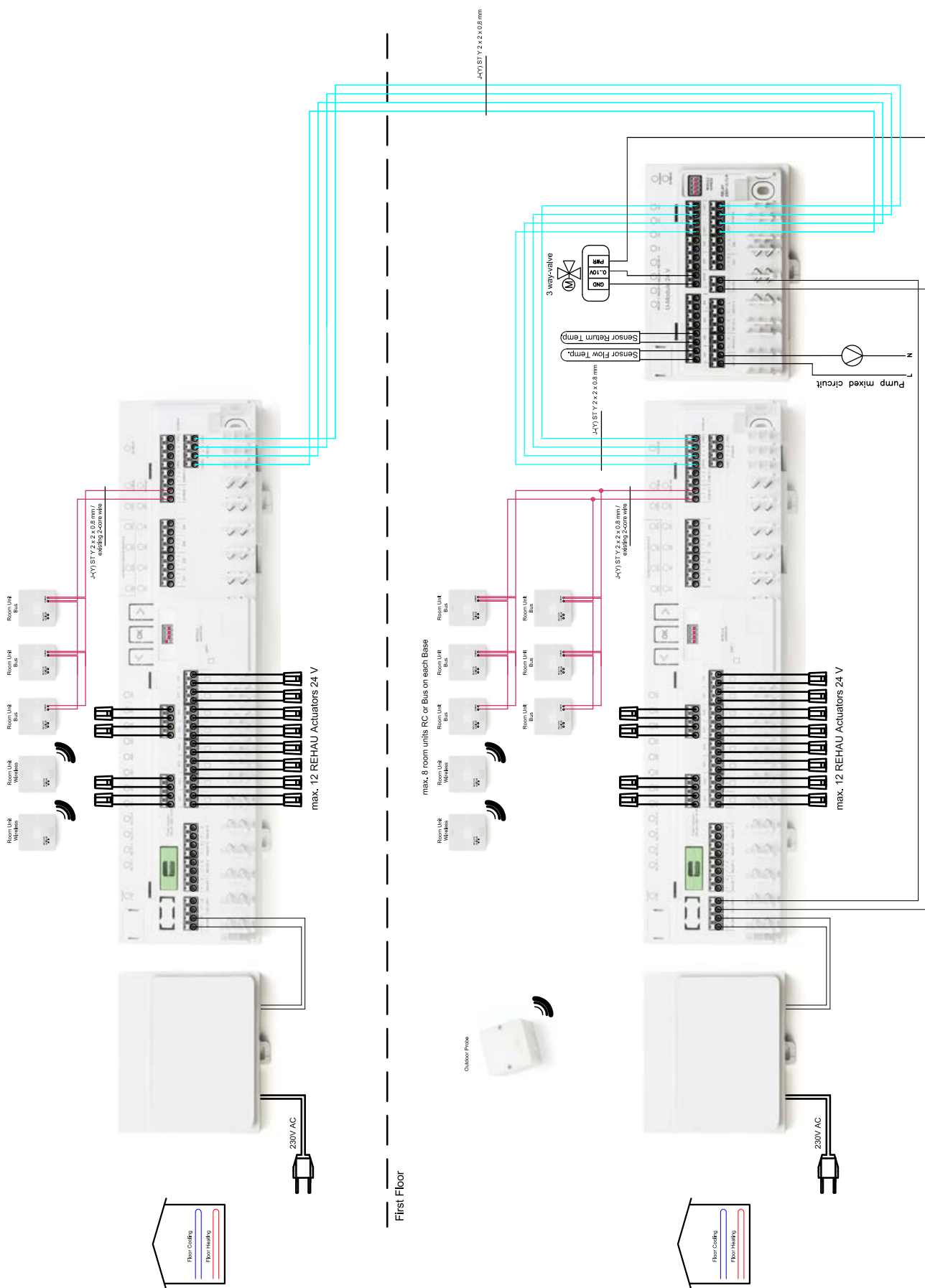

Fig. 11-6 Simple Room Temperature Control with mixed circuit - Underfloor heating and cooling - House/ Apartment with two floors

11.01.07 Room Temperature Control with chilled ceiling, mixed circuit and two dehumidifiers

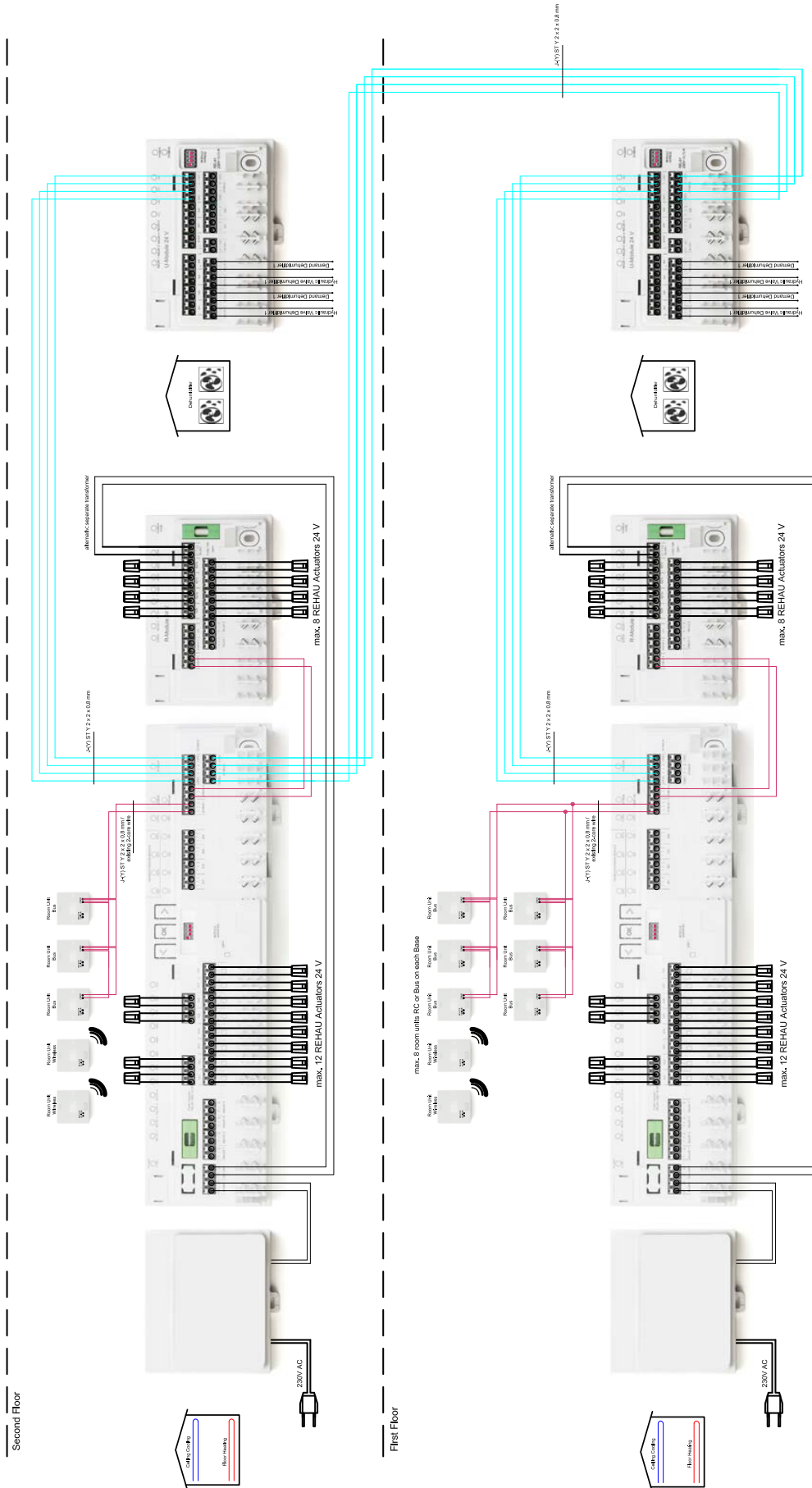

Fig. 11-7 Room Temperature Control with chilled ceiling, mixed circuit and two dehumidifiers - Underfloor heating + chilled ceiling + dehumidifier - House/ Apartment with two floors

11.01.08 Simple Room Temperature Control with chilled ceiling, mixed circuit and dehumidifiers

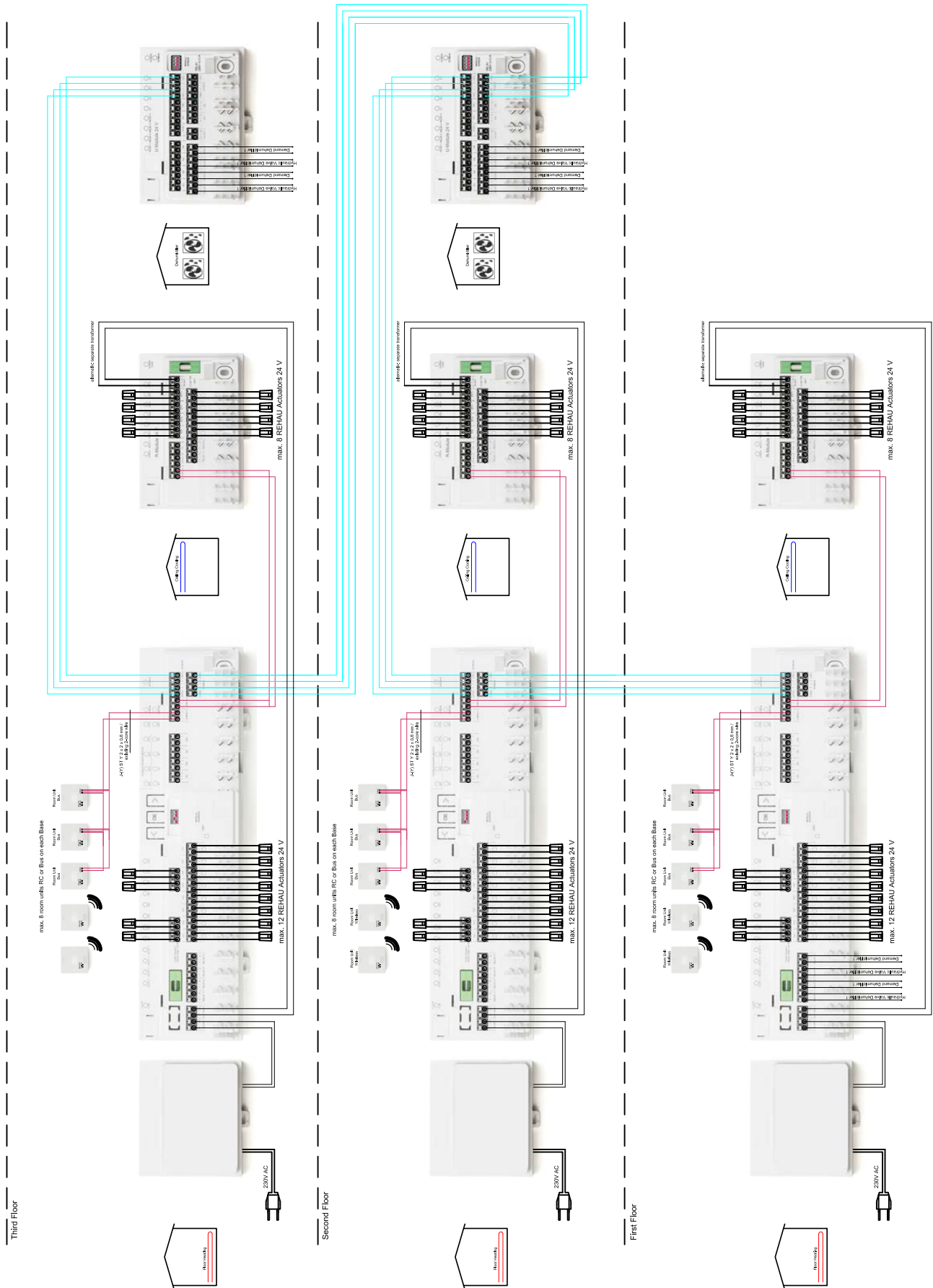

Fig. 11-8 Simple Room Temperature Control with chilled ceiling, mixed circuit and dehumidifiers - Underfloor heating + chilled ceiling + dehumidifier - House with three floors

11.01.09 Large Room Temperature Control

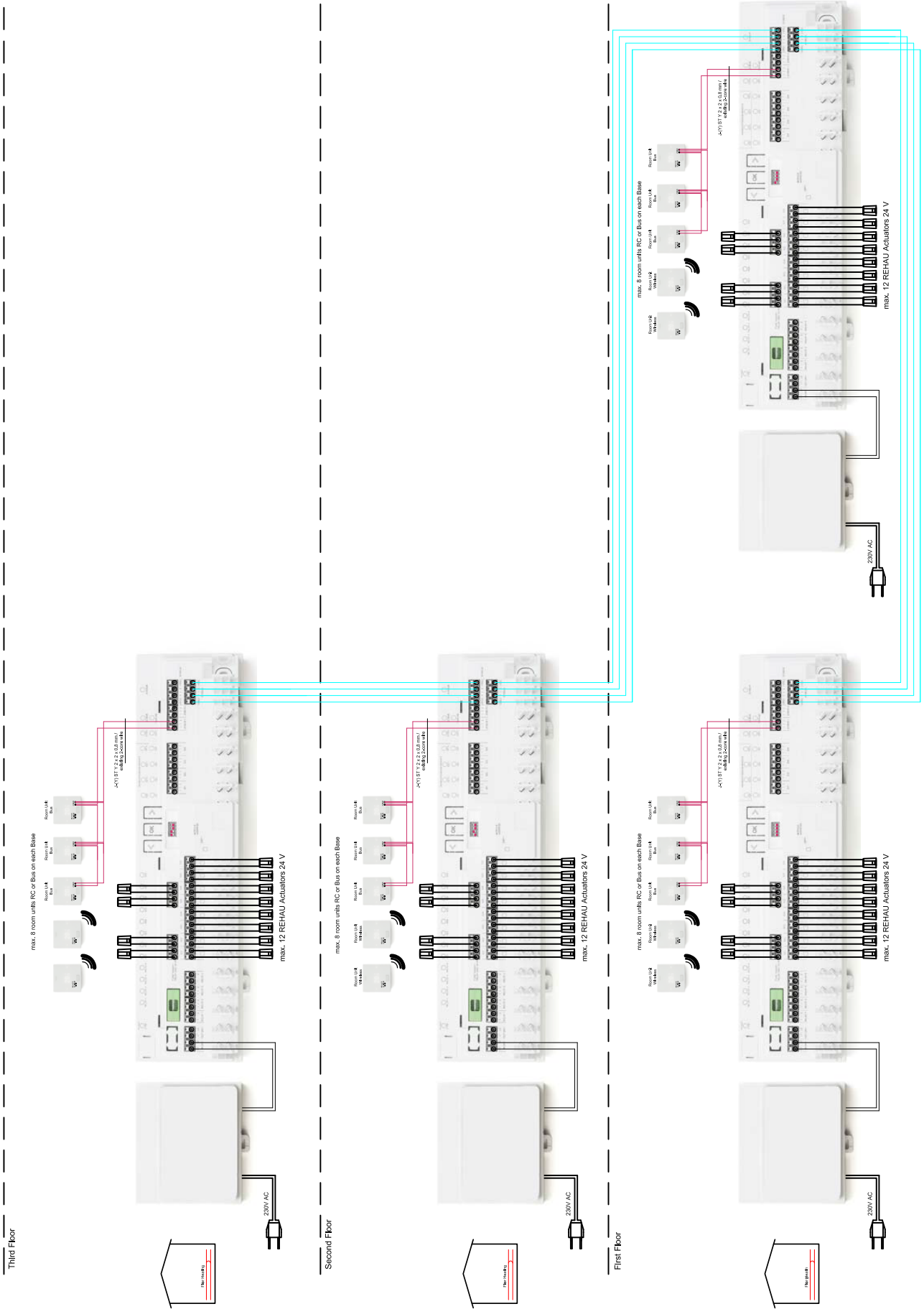

Fig. 11-9 Large Room Temperature Control - Underfloor heating - Light Commercial

12 Nomenclature

12.01 NEA SMART 2.0 Room unit

The NEA SMART 2.0 Room unit's functional features are indicated by a suffix, such as TRW or HRB.

The following naming system is used:

NEA SMART 2.0 Room unit XXX

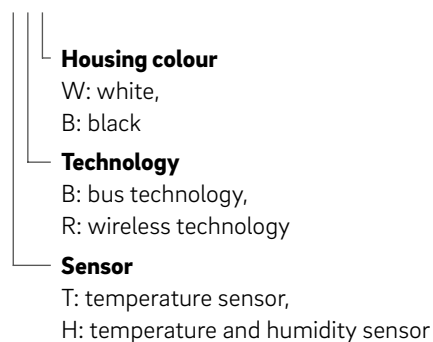

Features on the available variants

Room unit NEA SMART 2.0	Temperature	Temperature and humidity	Wired	Wireless	Housing, white	Housing, black	Illuminated frame
TBW	X		X		X		X
HBW		X	X		X		X
HBB		X	X			X	X
TRW	X			X	X		
HRW		X		X	X		
HRB		X		X		X	

Tab. 12-1 Functional features on the NEA SMART 2.0 Room unit variants

12.02 NEA SMART 2.0 Room probe

The NEA SMART 2.0 Room probe's features are indicated by a suffix, such as TBW or HBW.

The following naming system is used:

NEA SMART 2.0 Room probe XXX

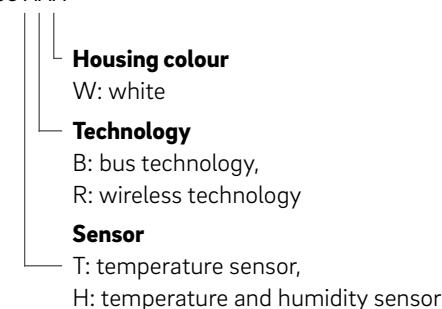

Features on the available variants

NEA SMART 2.0 Room probe	Temperature	Temperature and humidity	Wired	Wireless	Housing, white
TBW	X		X		X
HBW		X	X		X
TRW	X			X	X
HRW		X		X	X

Tab. 12-2 Functional features of the NEA SMART 2.0 Room probe

12.03 NEA SMART 2.0 Room unit TBW

Material number: 13280001001

This device can be used only with NEA SMART 2.0 Base 24 V, optional in combination with NEA SMART 2.0 R-Module 24 V.

Functional description

Bus based room unit for NEA SMART 2.0 control system, with temperature measurement and white LED dot-matrix display. Light ring for signalization and ambient light.

Technical data:

Power supply	Via zone bus (ZOBUS)
Digital outputs	-
Digital inputs	-
Analogue inputs	NTC input for external temperature probe NEA SMART 2.0 Remote Sensor
Analogue outputs	-
Accuracy temperature measurement	±0.8 K in temperature range +15 °C to +25 °C ±1 K in temperature range 0 °C to +45 °C
Temperature measurement range	-10 °C to 45 °C (displayed: 0 °C to 45 °C)
Safety class	III
Degree of protection	IP20
CE conformity according to	EN 60730
Degree of contamination	2 (IEC 60664-1)
Rated impulse voltage	2 kV (IEC61000-4-5)
Dimensions (W x H x D in mm)	86 x 86 x 21
Housing material	ABS/PC
Housing color	White (similar RAL 9003)
Weight	0.077 kg
Ambient temperature	0 °C to +50 °C
Ambient humidity	< 95 % r.H., non-condensing
Storage/transport temperature	-25 °C to +60 °C
Area of application	In enclosed rooms

12.04 NEA SMART 2.0 Room unit TRW

Material number: 13280101001

This device can be used only with NEA SMART 2.0 Base 24 V, optional in combination with NEA SMART 2.0 R-Module 24 V.

Functional description

Wireless operating room unit for NEA SMART 2.0 control system, with temperature measurement and white LED dot-matrix display.

Technical data:

Power supply	2 x LR03 (AAA) alkaline battery
Battery lifetime	2 years
Transmission frequency	869 MHz
Operating range	100 m outdoor, typical 25 m in buildings
Digital outputs	-
Digital inputs	-
Analogue inputs	NTC input for external temperature probe NEA SMART 2.0 Remote Sensor
Analogue outputs	-
Accuracy temperature measurement	±0.8 K in temperature range +15 °C to +25 °C ±1 K in temperature range 0 °C to +45 °C
Temperature measurement range	-10 °C to 45 °C (displayed: 0 °C to 45 °C)
Safety class	III
Degree of protection	IP20
CE conformity according to	EN 60730
Degree of contamination	2 (IEC 60664-1)
Rated impulse voltage	2 kV (IEC61000-4-5)
Dimensions (W x H x D in mm)	86 x 86 x 21
Housing material	ABS/PC
Housing color	White (similar RAL 9003)
Weight	0.1 kg
Ambient temperature	0 °C to +50 °C
Ambient humidity	< 95 % r.H., non-condensing
Storage/transport temperature	-25 °C to +60 °C
Area of application	In enclosed rooms

12.05 NEA SMART 2.0 Room unit HBW

Material number: 13280041001

This device can be used only with NEA SMART 2.0 Base 24 V, optional in combination with NEA SMART 2.0 R-Module 24 V.

Functional description

Bus based room unit for NEA SMART 2.0 control system, with temperature and humidity measurement and white LED dot-matrix display. Light ring for signalization and ambient light.

Technical data:

Power supply	Via zone bus (ZOBUS)
Digital outputs	-
Digital inputs	-
Analogue inputs	NTC input for external temperature probe NEA SMART 2.0 Remote Sensor
Analogue outputs	-
Accuracy temperature measurement	±0.8 K in temperature range +15 °C to +25 °C ±1 K in temperature range 0 °C to +45 °C
Temperature measurement range	-10 °C to 45 °C (displayed: 0°C to 45 °C)
Accuracy humidity measurement	±3 % in 20 – 80 % at 20 °C, ±5 % in other ranges
Humidity measurement range	0 – 100 %
Safety class	III
Degree of protection	IP20
CE conformity according to	EN 60730
Degree of contamination	2 (IEC 60664-1)
Rated impulse voltage	2 kV (IEC61000-4-5)
Dimensions (W x H x D in mm)	86 x 86 x 21
Housing material	ABS/PC
Housing color	White (similar RAL 9003)
Weight	0.077 kg
Ambient temperature	0 °C to +50 °C
Ambient humidity	< 95 % r.H., non-condensing
Storage/transport temperature	-25 °C to +60 °C
Area of application	In enclosed rooms

12.06 NEA SMART 2.0 Room unit HRW

Material number: 13280121001

This device can be used only with NEA SMART 2.0 Base 24 V, optional in combination with NEA SMART 2.0 R-Module 24 V.

Functional description

Wireless operating room unit for NEA SMART 2.0 control system, with temperature and humidity measurement and white LED dot-matrix display.

Technical data:

Power supply	2 x LR03 (AAA) alkaline battery
Battery lifetime	2 years
Transmission frequency	869 MHz
Operating range	100 m outdoor, typical 25 m in buildings
Digital outputs	-
Digital inputs	-
Analogue inputs	NTC input for external temperature probe NEA SMART 2.0 Remote Sensor
Analogue outputs	-
Accuracy temperature measurement	±0.8 K in temperature range +15 °C to +25 °C ±1 K in temperature range 0 °C to +45 °C
Temperature measurement range	-10 °C to 45 °C (displayed: 0 °C to 45 °C)
Accuracy humidity measurement	±3 % in 20 – 80 % at 20 °C, ±5 % in other ranges
Humidity measurement range	0 – 100 %
Safety class	III
Degree of protection	IP20
CE conformity according to	EN 60730
Degree of contamination	2 (IEC 60664-1)
Rated impulse voltage	2 kV (IEC61000-4-5)
Dimensions (W x H x D in mm)	86 x 86 x 21
Housing material	ABS/PC
Housing color	White (similar RAL 9003)
Weight	0.1 kg
Ambient temperature	0 °C to +50 °C
Ambient humidity	< 95 % r.H., non-condensing
Storage/transport temperature	-25 °C to +60 °C
Area of application	In enclosed rooms

12.07 NEA SMART 2.0 Room unit HBB

Material number: 13280051001

This device can be used only with NEA SMART 2.0 Base 24 V, optional in combination with NEA SMART 2.0 R-Module 24 V.

Functional description

Bus based room unit for NEA SMART 2.0 control system, with temperature and humidity measurement and white LED dot-matrix display. Light ring for signalization and ambient light.

Technical data:

Power supply	Via zone bus (ZOBUS)
Digital outputs	-
Digital inputs	-
Analogue inputs	NTC input for external temperature probe NEA SMART 2.0 Remote Sensor
Analogue outputs	-
Accuracy temperature measurement	±0.8 K in temperature range +15 °C to +25 °C ±1 K in temperature range 0 °C to +45 °C
Temperature measurement range	-10 °C to 45 °C (displayed: 0 °C to 45 °C)
Accuracy humidity measurement	±3 % in 20 – 80 % at 20 °C, ±5 % in other ranges
Humidity measurement range	0 – 100 %
Safety class	III
Degree of protection	IP20
CE conformity according to	EN 60730
Degree of contamination	2 (IEC 60664-1)
Rated impulse voltage	2 kV (IEC61000-4-5)
Dimensions (W x H x D in mm)	86 x 86 x 21
Housing material	ABS/PC
Housing color	Black (similar RAL 9011)
Weight	0.077 kg
Ambient temperature	0 °C to +50 °C
Ambient humidity	< 95 % r.H., non-condensing
Storage/transport temperature	-25 °C to +60 °C
Area of application	In enclosed rooms

12.08 NEA SMART 2.0 Room unit HRB

Material number: 13280131001

This device can be used only with NEA SMART 2.0 Base 24 V, optional in combination with NEA SMART 2.0 R-Module 24 V.

Functional description

Wireless operating room unit for NEA SMART 2.0 control system, with temperature and humidity measurement and white LED dot-matrix display.

Technical data:

Power supply	2 x LR03 (AAA) alkaline battery
Battery lifetime	2 years
Transmission frequency	869 MHz
Operating range	100 m outdoor, typical 25 m in buildings
Digital outputs	-
Digital inputs	-
Analogue inputs	NTC input for external temperature probe NEA SMART 2.0 Remote Sensor
Analogue outputs	-
Accuracy temperature measurement	±0.8 K in temperature range +15 °C to +25 °C ±1 K in temperature range 0 °C to +45 °C
Temperature measurement range	-10 °C to 45 °C (displayed: 0°C to 45 °C)
Accuracy humidity measurement	±3 % in 20 – 80 % at 20 °C, ±5 % in other ranges
Humidity measurement range	0 – 100 %
Safety class	III
Degree of protection	IP20
CE conformity according to	EN 60730
Degree of contamination	2 (IEC 60664-1)
Rated impulse voltage	2 kV (IEC61000-4-5)
Dimensions (W x H x D in mm)	86 x 86 x 21
Housing material	ABS/PC
Housing color	Black (similar RAL 9011)
Weight	0.1 kg
Ambient temperature	0 °C to +50 °C
Ambient humidity	< 95 % r.H., non-condensing
Storage/transport temperature	-25 °C to +60 °C
Area of application	In enclosed rooms

12.09 NEA SMART 2.0 Room probe TBW

Material number: 13280061001

This device can be used only with NEA SMART 2.0 Base 24 V, optional in combination with NEA SMART 2.0 R-Module 24 V.

Functional description

Bus based room unit for NEA SMART 2.0 control system, with temperature measurement.

Technical data:

Power supply	Via zone bus (ZOBUS)
Digital outputs	-
Digital inputs	-
Analogue inputs	NTC input for external temperature probe NEA SMART 2.0 Remote Sensor
Analogue outputs	-
Accuracy temperature measurement	±0.8K in temperature range +15°C to +25°C ±1K in temperature range 0°C to +45°C
Temperature measurement range	-10°C to 45°C (displayed: 0°C to 45°C)
Safety class	III
Degree of protection	IP20
CE conformity according to	EN 60730
Degree of contamination	2 (IEC 60664-1)
Rated impulse voltage	2kV (IEC61000-4-5)
Dimensions (W x H x D in mm)	86 x 86 x 21
Housing material	ABS/PC
Housing color	White (similar RAL 9003)
Weight	0.077 kg
Ambient temperature	0°C to +50°C
Ambient humidity	< 95% r.H., non-condensing
Storage/transport temperature	-25 °C to +60 °C
Area of application	In enclosed rooms

12.10 NEA SMART 2.0 Room probe HBW

Material number: 13280081001

This device can be used only with NEA SMART 2.0 Base 24 V, optional in combination with NEA SMART 2.0 R-Module 24 V.

Functional description

Bus based room unit for NEA SMART 2.0 control system, with temperature and humidity measurement.

Technical data:

Power supply	Via zone bus (ZOBUS)
Digital outputs	-
Digital inputs	-
Analogue inputs	NTC input for external temperature probe NEA SMART 2.0 Remote Sensor
Analogue outputs	-
Accuracy temperature measurement	±0.8 K in temperature range +15 °C to +25 °C ±1 K in temperature range 0 °C to +45 °C
Temperature measurement range	-10 °C to 45 °C (displayed: 0 °C to 45 °C)
Accuracy humidity measurement	±3 % in 20 – 80 % at 20 °C, ±5 % in other ranges
Humidity measurement range	0 – 100 %
Safety class	III
Degree of protection	IP20
CE conformity according to	EN 60730
Degree of contamination	2 (IEC 60664-1)
Rated impulse voltage	2 kV (IEC61000-4-5)
Dimensions (W x H x D in mm)	86 x 86 x 21
Housing material	ABS/PC
Housing color	White (similar RAL 9003)
Weight	0.077 kg
Ambient temperature	0 °C to +50 °C
Ambient humidity	< 95 % r.H., non-condensing
Storage/transport temperature	-25 °C to +60 °C
Area of application	In enclosed rooms

12.11 NEA SMART 2.0 Room probe TRW

Material number: 13280141001

This device can be used only with NEA SMART 2.0 Base 24 V, optional in combination with NEA SMART 2.0 R-Module 24 V.

Functional description

Wireless operating room unit for NEA SMART 2.0 control system, with temperature measurement.

Technical data:

Power supply	2 x LR03 (AAA) alkaline battery
Battery lifetime	2 years
Transmission frequency	869 MHz
Operating range	100 m outdoor, typical 25 m in buildings
Digital outputs	-
Digital inputs	-
Analogue inputs	NTC input for external temperature probe NEA SMART 2.0 Remote Sensor
Analogue outputs	-
Accuracy temperature measurement	±0.8 K in temperature range +15 °C to +25 °C ±1 K in temperature range 0 °C to +45 °C
Temperature measurement range	-10 °C to 45 °C (displayed 0 °C to 45 °C)
Safety class	III
Degree of protection	IP20
CE conformity according to	EN 60730
Degree of contamination	2 (IEC 60664-1)
Rated impulse voltage	2 kV (IEC61000-4-5)
Dimensions (W x H x D in mm)	86 x 86 x 21
Housing material	ABS/PC
Housing color	White (similar RAL 9003)
Weight	0.1 kg
Ambient temperature	0 °C to +50 °C
Ambient humidity	< 95 % r.H., non-condensing
Storage/transport temperature	-25 °C to +60 °C
Area of application	In enclosed rooms

12.12 NEA SMART 2.0 Room probe HRW

Material number: 13280161001

This device can be used only with NEA SMART 2.0 Base 24 V, optional in combination with NEA SMART 2.0 R-Module 24 V.

Functional description

Wireless operating room unit for NEA SMART 2.0 control system, with temperature and humidity measurement.

Technical data:

Power supply	2 x LR03 (AAA) alkaline battery
Battery lifetime	2 years
Transmission frequency	869 MHz
Operating range	100 m outdoor, typical 25 m in buildings
Digital outputs	-
Digital inputs	-
Analogue inputs	NTC input for external temperature probe NEA SMART 2.0 Remote Sensor
Analogue outputs	-
Accuracy temperature measurement	±0.8K in temperature range +15 °C to +25 °C ±1 K in temperature range 0 °C to +45 °C
Temperature measurement range	-10 °C to 45 °C (displayed 0 °C to 45 °C)
Accuracy humidity measurement	±3 % in 20 – 80 % at 20 °C, ±5 % in other ranges
Humidity measurement range	0 – 100 %
Safety class	III
Degree of protection	IP20
CE conformity according to	EN 60730
Degree of contamination	2 (IEC 60664-1)
Rated impulse voltage	2 kV (IEC61000-4-5)
Dimensions (W x H x D in mm)	86 x 86 x 21
Housing material	ABS/PC
Housing color	White (similar RAL 9003)
Weight	0.1 kg
Ambient temperature	0 °C to +50 °C
Ambient humidity	< 95 % r.H., non-condensing
Storage/transport temperature	-25 °C to +60 °C
Area of application	In enclosed rooms

12.13 NEA SMART 2.0 Base 24 V

Material number: 13280241001

Functional description

Central controller for NEA SMART 2.0 control system for energy efficient operating of radiant heating and cooling systems in combination with radiators, flow temperature control, dehumidifiers.

Suitable for all Nea Smart 2.0 room units and probes in Bus- and RC technology (hybrid technology).

Operating and monitoring of system functions by REHAU app, connection to REHAU cloud.

Room temperature control of up to 8 rooms, up to 12 actuators can be connected.

Expendable via zone bus (ZOBUS) by R-Module for 4 additional rooms, system expansion via system bus

by up to 4 additional NEA SMART 2.0 Base 24 V, this allows up to 60 rooms to be controlled.

Additional functions by NEA SMART 2.0 U-Module: flow temperature control or control of dehumidifiers.

4 relay outputs (dry contacts) for control of pump, dehumidifier, boiler and chiller, 4 digital inputs for change over signal, dew point monitor, mode selection

Communication possibilities:

- ZOBUS (2-wire bus for Nea Smart 2.0 Room Units) and 869 MHz RC network for Nea Smart 2.0 Room Units
- System bus for connection of extension modules and Nea Smart 2.0 Base 24 V
- WLAN and LAN for connection to router and internet, integrated web pages for installation and operating by web browser.

Technical data:

Operating voltage	24 V AC \pm 15 % / 50 Hz
Power consumption	3 W (without actuators, without R-Module, without U-Module)
Digital outputs	8 Triac outputs for REHAU actuators, switching capacity 1 A, 24 VAC, maximum load per output: 4 REHAU Actuator 24 V, 4 relay outputs (dry contacts) 230 V, 5 A, Class II
Fuse	T2A
Digital inputs	4 inputs for dry contacts
Analogue inputs	-
Analogue outputs	-
RC Transmission frequency	869 MHz
Temperature measurement range	100 m outdoor, typical 25 m in buildings
Bus system 1	Zone bus (ZOBUS): 2-wire bus system, polarity free, maximum length 100 m, no twisted pair or shielded cable needed
Bus system 2	System bus: 3-wire RS 485 bus system, maximum length between 2 Bases 250 m, absolute maximum length is 500 m. Twisted pair and shielded cable needed. Recommendation J-Y(ST)Y 2 x 2 x 0.8 mm
WLAN	IEEE 802.11n, WPA2
LAN	IEEE 802.3 10/100 Base-T
Safety class	II
Degree of protection	IP20
CE conformity according to	EN 60730
Degree of contamination	2 (IEC 60664-1)
Rated impulse voltage	2 kV (IEC61000-4-5)
Dimensions (W x H x D in mm)	317 x 83,5 x 52,6
Housing material	ABS/PC
Housing color	white (similar RAL 9003)
Weight	0.535 kg
Ambient temperature	0 °C to +50 °C
Ambient humidity	< 95 % r.H., non-condensing
Storage/transport temperature	-25 °C to +60 °C
Area of application	In enclosed rooms

12.14 NEA SMART 2.0 Base 230 V

Material number: 13282301001

Functional description

Central controller for NEA SMART 2.0 control system for energy efficient operating of radiant heating and cooling systems in combination with radiators, flow temperature control, dehumidifiers.

Suitable for all Nea Smart 2.0 room units and probes in Bus- and RC technology (hybrid technology).

Operating and monitoring of system functions by REHAU app, connection to REHAU cloud.

Room temperature control of up to 8 rooms, up to 12 actuators can be connected.

Expendable via zone bus (ZOBUS) by R-Module for 4 additional rooms, system expansion via system bus

by up to 4 additional NEA SMART 2.0 Base 230 V, this allows up to 60 rooms to be controlled.

Additional functions by NEA SMART 2.0 U-Module: flow temperature control or control of dehumidifiers.

4 relay outputs (dry contacts) for control of pump, dehumidifier, boiler and chiller, 4 digital inputs for change over signal, dew point monitor, mode selection.

Communication possibilities:

- ZOBUS (2-wire bus for Nea Smart 2.0 Room Units) and 869 MHz RC network for Nea Smart 2.0 Room Units
- System bus for connection of extension modules and Nea Smart 2.0 Base 24 V
- WLAN and LAN for connection to router and internet, integrated web pages for installation and operating by web browser.

Technical data:

Operating voltage	230V AC ±15 % / 50 Hz
Power consumption	3,5 W (without actuators, without R-Module, without U-Module)
Digital outputs	8 Triac outputs for REHAU actuators, switching capacity 0.5 A non inductive, 230 VAC, maximum load per output: 4 REHAU Actuator 230 V, 4 relay outputs (dry contacts) 230 V, 5 A, Class II
Fuse	T2A, 5 x 20 mm
Digital inputs	4 inputs for dry contacts
Analogue inputs	-
Analogue outputs	-
RC Transmission frequency	869 MHz
Temperature measurement range	100 m outdoor, typical 25 m in buildings
Bus system 1	Zone bus (ZOBUS): 2-wire bus system, polarity free, maximum length 100 m, no twisted pair or shielded cable needed
Bus system 2	System bus: 3-wire RS 485 bus system, maximum length between 2 Bases 250 m, absolute maximum length is 500 m. Twisted pair and shielded cable needed. Recommendation J-Y(ST)Y 2 x 2 x 0.8 mm
WLAN	IEEE 802.11n, WPA2
LAN	IEEE 802.3 10/100 Base-T
Safety class	II
Degree of protection	IP20
CE conformity according to	EN 60730
Degree of contamination	2 (IEC 60664-1)
Rated impulse voltage	2 kV (IEC61000-4-5)
Dimensions (W x H x D in mm)	317 x 83,5 x 52,6
Housing material	ABS/PC
Housing color	white (similar RAL 9003)
Weight	0.65 kg
Ambient temperature	0 °C to +50 °C
Ambient humidity	< 95 % r.H., non-condensing
Storage/transport temperature	-25 °C to +60 °C
Area of application	In enclosed rooms

12.15 NEA SMART 2.0 R-Module 24 V

Material number: 13280201001

Functional description

Extension module to increase the number of control channels of a NEA SMART 2.0 Base 24 V by 4 additional channels. This device works only with a NEA SMART 2.0 Base 24 V. Only 1 NEA SMART 2.0 R-Module 24 V may be connected to a NEA SMART 2.0 Base 24 V.

Suitable for all NEA SMART 2.0 room units and probes in Bus- and RC technology (hybrid technology of NEA SMART 2.0 Base).

2 relay outputs (dry contacts) for control of pump, dehumidifier, boiler and chiller, 1 configurable digital input.

Communication to NEA SMART 2.0 Base 24 V by ZOBUS (2-wire bus).

Technical data:

Power supply	By ZOBUS (from NEA SMART 2.0 Base 24 V)
Power supply for actuators	24 V AC $\pm 15\%$ / 50 Hz
Digital outputs	4 Triac outputs for REHAU actuators, switching capacity 1 A, 24 VAC, maximum load per output: 4 REHAU Actuator 24 V 2 relay outputs (dry contacts) 230 V, 5 A, Class II
Fuse	T2A
Digital inputs	1 input for dry contact
Analogue inputs	-
Analogue outputs	-
Bus system	Zone bus (ZOBUS): 2-wire bus system, polarity free, maximum length 100 m, no twisted pair or shielded cable needed
Safety class	II
Degree of protection	IP20
CE conformity according to	EN 60730
Degree of contamination	2 (IEC 60664-1)
Rated impulse voltage	2 kV (IEC61000-4-5)
Dimensions (W x H x D in mm)	125,5 x 83,5 x 52,6
Housing material	ABS/PC
Housing color	white (similar RAL 9003)
Weight	0.235 kg
Ambient temperature	0 °C to +50 °C
Ambient humidity	< 95 % r.H., non-condensing
Storage/transport temperature	-25 °C to +60 °C
Area of application	In enclosed rooms

12.16 NEA SMART 2.0 R-Module 230 V

Material number: 13280211001

Functional description

Extension module to increase the number of control channels of a NEA SMART 2.0 Base 230 V by 4 additional channels. This device works only with a NEA SMART 2.0 Base 230 V. Only 1 NEA SMART 2.0 R-Module 230 V may be connected to a NEA SMART 2.0 Base 230 V.

Suitable for all NEA SMART 2.0 room units and probes in Bus- and RC technology (hybrid technology of NEA SMART 2.0 Base).

2 relay outputs (dry contacts) for control of pump, dehumidifier, boiler and chiller, 1 configurable digital input.

Communication to NEA SMART 2.0 Base 230 V by ZOBUS (2-wire bus) NEA SMART 2.0 U-Module 24 V.

Technical data:

Power supply	By ZOBUS (from NEA SMART 2.0 Base 230 V)
Power supply for actuators	230 V AC $\pm 15\%$ / 50 Hz
Digital outputs	4 Triac outputs for REHAU actuators, switching capacity 0,5 A, 230 VAC, maximum load per output: 4 REHAU Actuator 230 V 2 relay outputs (dry contacts) 230 V, 5 A, Class II
Fuse	T1.6A, 5 x 20 mm
Digital inputs	1 input for dry contact
Analogue inputs	-
Analogue outputs	-
Bus system	Zone bus (ZOBUS): 2-wire bus system, polarity free, maximum length 100 m, no twisted pair or shielded cable needed
Safety class	II
Degree of protection	IP20
CE conformity according to	EN 60730
Degree of contamination	2 (IEC 60664-1)
Rated impulse voltage	2 kV (IEC61000-4-5)
Dimensions (W x H x D in mm)	125,5 x 83,5 x 52,6
Housing material	ABS/PC
Housing color	white (similar RAL 9003)
Weight	0.260 kg
Ambient temperature	0 °C to +50 °C
Ambient humidity	< 95 % r.H., non-condensing
Storage/transport temperature	-25 °C to +60 °C
Area of application	In enclosed rooms

12.17 NEA SMART 2.0 U-Module 24 V

Material number: 13280221001

4 configurable digital inputs.

Functional description

Universal extension module with configurable functions:

Control of 1 mixed circuit or control of up to 2 dehumidifiers.

4 relay outputs (dry contacts), for control of pump and dehumidifier.

3 analogue inputs NTC 10 K.

All inputs/outputs are predefined according to selected function.

This device works only in the system bus network of NEA SMART 2.0 Base 24 V.

Technical data:

Power supply	By VDC output of NEA SMART 2.0 Base 24 V
Power supply for actuators	24 V AC $\pm 15\%$ / 50 Hz
Digital outputs	4 relay outputs (dry contacts) 230 V, 5 A, Class II
Digital inputs	4 input for dry contact
Analogue inputs	AI1, AI2, AI3: NTC 10 K
Analogue outputs	1 output 0 ... 10 V
Bus system	System bus: 3-wire RS 485 bus system, maximum length between 2 controllers 250 m, absolute maximum length is 500 m Twisted pair and shielded cable needed. Recommendation J-Y(ST)Y 2 x 2 x 0.8 mm
Safety class	II
Degree of protection	IP20
CE conformity according to	EN 60730
Degree of contamination	2 (IEC 60664-1)
Rated impulse voltage	2 kV (IEC61000-4-5)
Dimensions (W x H x D in mm)	125.5 x 83.5 x 52.6
Housing material	ABS/PC
Housing color	white (similar RAL 9003)
Weight	0.235 kg
Ambient temperature	0 °C to +50 °C
Ambient humidity	< 95 % r.H., non-condensing
Storage/transport temperature	-25 °C to +60 °C
Area of application	In enclosed rooms

12.18 NEA SMART 2.0 Transformer

Material number: 13280191001

Functional description

Safety transformer for NEA SMART 2.0 system components.

Primary voltage 230 V AC, secondary voltage 24 V AC with maximum power 60 VA.

Technical data:

Primary voltage	230 V AC $\pm 15\%$ / 50 Hz
Secondary voltage	24 V AC $\pm 15\%$ / 50 Hz
Maximum power	60 VA
Idle-time power consumption	< 2,5 W
Integrated fuse	Thermal fuse @130 °C
Safety class	II
Degree of protection	IP20
CE conformity according to	EN 61558
Dimensions (W x H x D in mm)	94 x 83.5 x 66.4
Housing material	ABS
Housing color	white (similar RAL 9003)
Weight	1.8 kg
Ambient temperature	-25 °C to +50 °C
Ambient humidity	< 95 % r.H., non-condensing
Storage/transport temperature	-25 °C to +60 °C
Area of application	In enclosed rooms

12.19 NEA SMART 2.0 Remote sensor

Material number: 13280331001

Functional description

Remote sensor for NEA SMART 2.0 Room units for:

- Floor temperature monitoring
- Usage as additional room temperature probe.

Technical data:

Power supply	none
Sensor type	NTC 10 K
Sensor accuracy	±5 % @25 °C
Degree of protection	IP67
CE conformity according to	EN 60730
Dimensions probe element (W x H x D in mm)	28 x 6 x 6
Cable length	3 m
Housing material	PBT for sensor housing, PVC for cable (UL2517)
Housing color	white (similar RAL 9003)
Weight	0.065 kg
Ambient temperature	-20 °C to +60 °C
Ambient humidity	< 95 % r.H., non-condensing
Storage/transport temperature	-25 °C to +60 °C
Area of application	In enclosed rooms

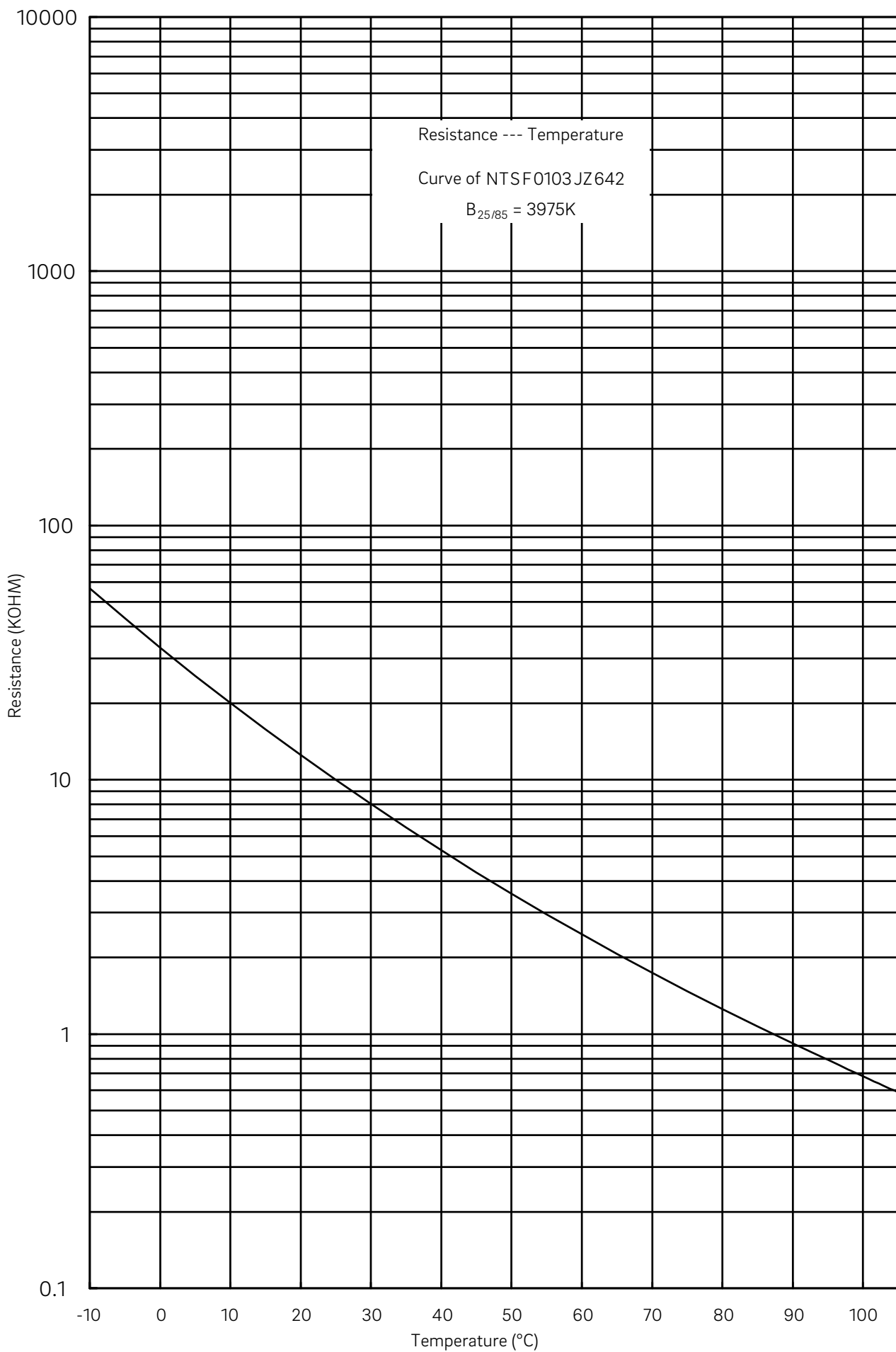

12.20 NEA SMART 2.0 VL/RL sensor

Material number: 13280391001

Functional description

Flow and return sensor for NEA SMART 2.0 U-Module
for:

- Flow temperature monitoring
- Return temperature monitoring.

Technical data:

Power supply	none
Sensor type	NTC 10 K
Sensor accuracy	±5 % @25 °C
Degree of protection	IP67
CE conformity according to	EN 60730
Dimensions probe element (W x H x D in mm)	45 x 5 x 5
Cable length	3 m
Housing material	Stainless steel for sensor, PVC for cable (UL2517)
Housing color	white (similar RAL 9003)
Weight	0.065 kg
Ambient temperature	-20 °C to +60 °C
Ambient humidity	< 95 % r.H., non-condensing
Storage/transport temperature	-25 °C to +60 °C
Area of application	In enclosed rooms

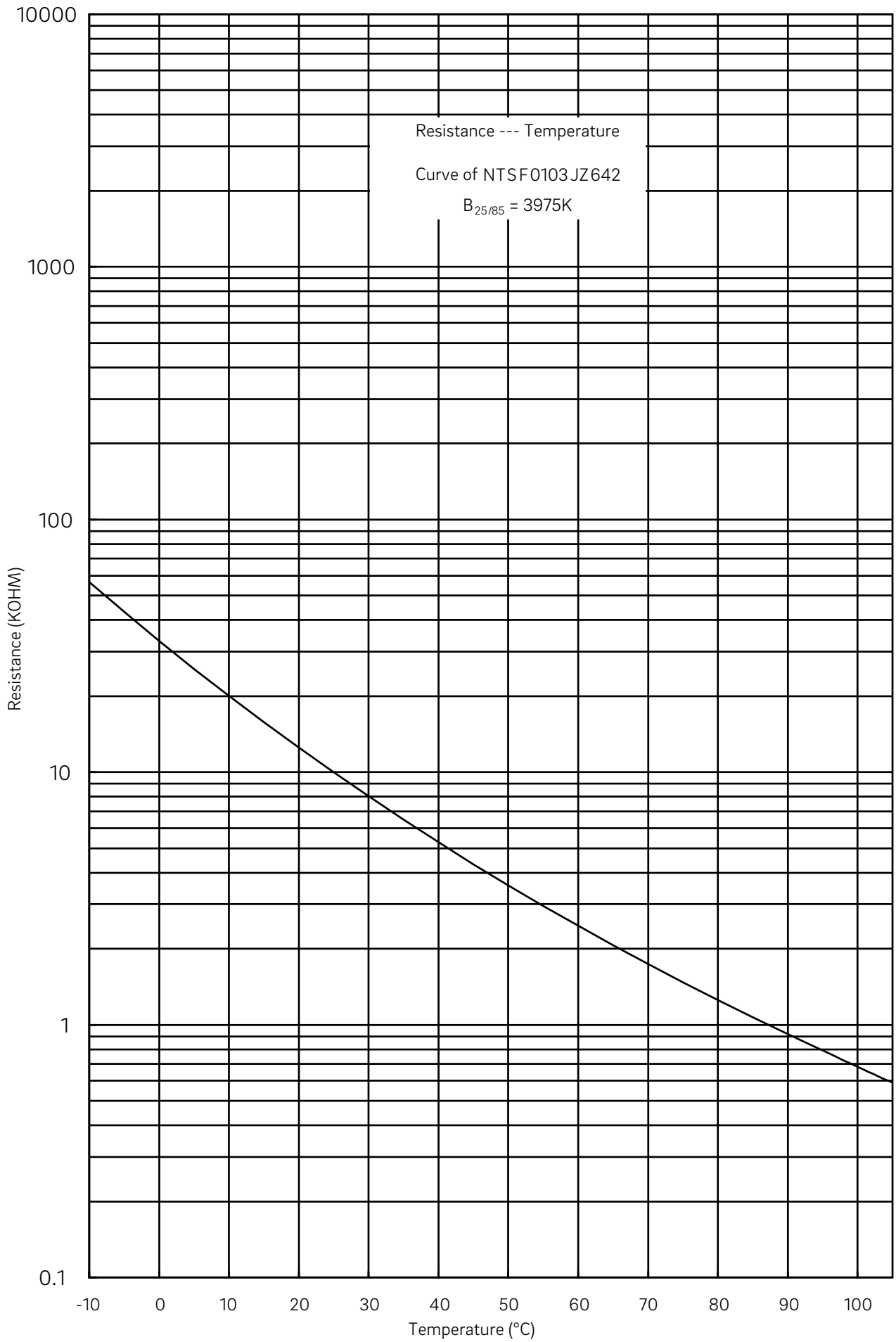

12.21 NEA SMART 2.0 Outdoor sensor

Material number: 13280341001

Functional description

Wireless operating outside temperature probe for NEA SMART 2.0 control system.

This device can be used only with NEA SMART 2.0 Base 24 V.

Technical data:

Power supply	1 x LR06 (AA) Lithium battery 3,6 V
battery lifetime	5 years
Transmission frequency	869 MHz
Operating range	180 m outdoor, typical 30 m in buildings
Accuracy temperature measurement	±0.8 K in temperature range +15 °C to +25 °C ±1 K in temperature range -40 °C to +50 °C
Temperature measurement range	-20 °C to +50 °C
Safety class	III
Degree of protection	IP45
CE conformity according to	EN 60730
Dimensions (W x H x D in mm)	80 x 80 x 52
Cable length	3 m
Housing material	ABS
Housing color	white (similar RAL 9003)
Weight	0.114 kg
Ambient temperature	-40 °C to +50 °C
Ambient humidity	< 95 % r.H., non-condensing
Storage/transport temperature	-25 °C to +60 °C

12.22 NEA SMART 2.0 Antenna

Material number: 13280351001

Functional description

External antenna for NEA SMART 2.0 Base for radio communication to NEA SMART 2.0 Room units (869 MHz).

Technical data:

Power supply	By NEA SMART 2.0 Base
Operating range in buildings	25 m
Safety class	III
Degree of protection	IP30
RC Transmission frequency	869 MHz
CE conformity according to	EN 60730
Dimensions (W x H x D in mm)	186 x 22 x 11
Housing material	PVC
Housing color	white (similar RAL 9010)
Weight	0.060 kg
Ambient temperature	0 °C to +50 °C
Ambient humidity	< 95 % r.H., non-condensing
Storage/transport temperature	-25 °C to +60 °C
Area of application	In enclosed rooms

12.23 Thermal actuator UNI 24 V

Material number: 13202761001

Functional description

To actuate the control valves in the REHAU manifold and the thermostatic valves in the REHAU industrial manifold.

Technical data:

Operating voltage	24 V AC/DC, +20 % ... -10 %
Operating output	1 W
Switch-on current	< 300 mA for max. 2 min.
Actuating range	4.0 mm
Actuating force	100 N ±5 %
Protection class/protection rating	III / IP54
CE conformity as per	EN 60730
Dimensions (W x H x D in mm)	44 x 52 x 48
Cable length	1 m
Housing material	Polyamide
Housing color	Light grey (RAL 7035)
Weight	0.130 kg
Ambient temperature	0 °C to +60 °C
Storage/transport temperature	-25 °C to +60 °C
Usage environment	In dry closed rooms

12.24 Thermal actuator UNI 230 V

Material number: 13202751001

Functional description

To actuate the control valves in the REHAU manifold and the thermostatic valves in the REHAU industrial manifold.

Technical data:

Operating voltage	230 V AC +10 % ... -10 %, 50/60 V
Operating output	1 W
Switch-on current	< 550 mA for max. 100 ms.
Actuating range	4.0 mm
Actuating force	100 N ±5 %
Protection class/protection rating	II/IP54
CE conformity as per	EN 60730
Dimensions (W x H x D in mm)	44 x 52 x 48
Cable length	1 m
Housing material	Polyamide
Housing color	Light grey (RAL 7035)
Weight	0.130 kg
Ambient temperature	0 °C to +60 °C
Storage/transport temperature	-25 °C to +60 °C
Usage environment	In dry closed rooms

12.25 Thermal actuator MINI 24 V

Material number: 13203961001

Functional description

For controlling the regulating valves of the manifold RAUTHERM SPEED HKV-D P connector 16 and 17 as well as other REHAU manifolds.

Technical data:

Operating voltage	24 V AC/DC, +20 % ... -10 %
Operating power	1.2 W
Inrush current	< 300 mA for max. 2 min.
Maximum stroke	3.5 mm
Actuation force	90 N ±10 %
Degree of protection / Safety class	IP54 / III
CE Conformity acc.	EN 60730
Dimensions: (W x H x D in mm)	36 x 48 x 49
Cable length	1 m
Housing material	Polyamid
Housing color	light grey (RAL 7035)
Weight	0.1 kg
Ambient temperature	0 °C ... +60 °C
Storage / transport temperature	-25 °C ... +60 °C
Application environment	In dry closed rooms

12.26 Thermal actuator MINI 230 V

Material number: 13203951001

Functional description

For controlling the regulating valves of the manifold RAUTHERM SPEED HKV-D P connector 16 and 17 as well as other REHAU manifolds.

Technical data:

Operating voltage	230 V AC, +10 % ... -10 %
Operating power	1.2 W
Inrush current	< 550 mA for max. 100 ms
Maximum stroke	3.5 mm
Actuation force	90 N \pm 10 %
Degree of protection / Safety class	IP54 / II
CE Conformity acc.	EN 60730
Dimensions: (W x H x D in mm)	36 x 48 x 49
Cable length	1 m
Housing material	Polyamid
Housing color	light grey (RAL 7035)
Weight	0.1 kg
Ambient temperature	0 °C ... +60 °C
Storage / transport temperature	-25 °C ... +60 °C
Application environment	In dry closed room

12.27 Actuator BALANCE 24 V

Material number: 13955461001

Functional description

For controlling the valves of the REHAU manifolds as well as the thermostat valves of the REHAU industrial manifolds.

Technical data:

Operating voltage	24 V AC/DC, +20 % ... -10 %
Operating power	< 0.5 W
Inrush current	30 mA for max. 200 ms
Maximum stroke	4.5 mm
Actuation force	100 N
Control characteristic	PID, adaptive
Medium temperature	0 – 60 °C
Storage temperature	-25 °C to +60 °C
Ambient temperature	max. 50 °C
Degree of protection / Safety class	IP54/III
Dimensions (W x H x D in mm)	37.8 x 95.3 x 53.2
Cable length	1 m
Housing material	Upper part MT11005, Lower part VDI24
Housing color l	RAL 9003
Weight	188 g
Application environment	In dry closed rooms

12.28 Actuator BALANCE 230 V

Material number: 13955441001

Functional description

For controlling the valves of the REHAU manifolds as well as the thermostat valves of the REHAU industrial manifolds.

Technical data:

Operating voltage	230 V AC, +10 % ... -10 % (50 Hz - 60 Hz)
Operating power	< 0.5 W
Inrush current	30 mA for max. 200 ms
Maximum stroke	4.5 mm
Actuation force	100 N
Control characteristic	PID, adaptive
Medium temperature	0 – 60 °C
Storage temperature	-25 °C to +60 °C
Ambient temperature	max. 50 °C
Degree of protection / Safety class	IP54/II
Dimensions (W x H x D in mm)	37.8 x 95.3 x 53.2
Cable length	1 m
Housing material	Upper part MT11005, Lower part VDI24
Housing color l	RAL 9003
Weight	188 g
Application environment	In dry closed rooms

12.29 Coupling relay 24 V / 230 V

Material number:

13388021001 Coupling relay 24 V

13388031001 Coupling relay 230 V

Functional description

Suitable for passing 24 V AC or 230 V AC switching signals to digital inputs of the NEA SMART 2.0 or Nea control system.

Technical data:

Coil voltage	24 V AC / 230 V AC
contacts, maximum continuous current	8:00 AM
Conformity	DIN VDE 0815, 2014/35/EU
Dimensions (W x H x D in mm)	18 x 62 x 75
Weight	70 g
Ambient temperature	-40 °C ... 85 °C
Application environment	In dry closed rooms

12.30 Switching relay 24 V / 230 V

Material number:

13388041001 Switching relay 24 V

13388061001 Switching relay 230 V

Functional description

Suitable for connection to triac or relay outputs of control system NEA SMART 2.0 24 V and for connection to outputs of control system Nea 24 V or 230 V. The switching relays allow controlling external devices, to switch additional actuators, or to transmit signals to other building technology units.

Technical data:

Coil voltage	24 V AC / 230 V AC
contacts, maximum continuous current	25 A
Conformity:	DIN VDE 0815, 2014/35/EU
Dimensions (W x H x D in mm)	18 x 62 x 85
Weight	88 g
Ambient temperature	-40 °C ... 85 °C
Application environment	In dry closed rooms

12.31 NEA SMART 2.0 KNX Gateway

Material number: 13388001001

Range of Application:

The NEA SMART 2.0 - KNX connection exchanges data (set points, actual values, operating modes and energy levels) between NEA SMART 2.0 and a centralised BMS System (KNX). The NEA SMART 2.0 KNX Gateway communicates with the NEA SMART 2.0 system via the SYSBUS, as a Modbus Slave. The assignment of KNX objects and Modbus registers can be configured via parameters in the ETS software (KNX license software). No additional software is required. The SYSBUS (Modbus) assignment required for the NEA SMART 2.0 control system can optionally imported via the provided example ETS project. The import of the SYSBUS (Modbus) assignments can be done in the office or on site.

The SYSBUS (Modbus) connection is galvanic isolated from the KNX Bus. The NEA SMART 2.0 Power Supply Gateway is used for the auxiliary voltage of the SYSBUS (Modbus). The KNX-Bus is supplied via the other KNX components on-site. The device is to be DIN rail mounted in permanent internal (dry location) installations only.

Technical data:

Operating voltage KNX	KNX operation voltage 30 V DC	
Power consumption KNX Bus	approx. 4 mA	
Auxiliary voltage Modbus / SYSBUS	12 ... 24 V DC	
Power consumption Modbus / SYSBUS	approx. 5 mA	
Storage temperature	-25 ... +70 °C	
Ambient temperature during operation	-5 ... +45 °C	
Rel. humidity (non-condensing)	5 % ... 93 %	
Degree of protection (acc. EN 60529)	IP 20	
Protection class	III	
CE conformity / standards	EMC directive 2014 / 30 / EU RoHS directive 2011 / 65 / EU EN 50491-3: 2009 EN 50491-5-1: 2010 EN 50491-5-2: 2010	EN 50491-5-3: 2010 EN 61000-6-2: 2005 EN 61000-6-3: 2007 + A1: 2011 EN 50581: 2012
Mounting	DIN rail mounted device	
Housing	DIN rail mounted device, width: 1 unit (18 mm)	
Control elements	2 buttons and 1 KNX programming button	
Indicators	3 LEDs multicolour	
Connector for KNX Bus	Red / black	
Connector for Modbus / SYSBUS	Pluggable screw connector (3 poles) for Modbus	
Connector for Modbus / SYSBUS Support voltage	Pluggable screw connector (3 poles) for power supply	
Cross-section of connectors	0.34 ... 2.5 mm ²	
Modbus / SYSBUS	Type: RTU (RS-485), Slave / Up to 250 Channels	
Dimension (B x H x T in mm)	17.5 x 59.8 x 89.8	
Housing material	Cover: PC Socket: PA 66/6	
Housing colour	Cover: Light grey RAL 7035 Socket: Graphite black RAL 9011	
Weight (approx.)	ca. 50 g	
Application environment	In dry closed rooms	

12.32 NEA SMART 2.0 Power supply gateway

Material number: 13388011001

Range of Application:

The NEA SMART 2.0 Power Supply Gateway is a DIN rail mounted power supply with a direct current output (DC). This AC/DC-power supply is used to transform the auxiliary voltage for the SYSBUS (Modbus) of the REHAU NEA SMART 2.0 KNX Gateways. The potentiometer adjusts the output voltage. The blue LED indicates operation. The power supply unit is suitable for building automation controls in commercial and private premises. The device is to be DIN rail mounted in permanent internal (dry location) installations only.

Technical data:

Operating voltage	85 V AC to 264 V AC
Frequency range	47 – 63 Hz
Power Intake	0.25 A / 230 V AC
Inrush current, max.	45 A / 230 V AC
Efficiency	85 %
Output Voltage	12 V DC
Output Voltage - Adjustment range	10.8 V DC to 13.8 V DC
Output Current	0 to 1,25 A
Output Power	15 W
Type	Switch Mode
Operating time max.	1166000 h
Ripple	120 mVss
Load Regulation	1 %
Special features	Short circuit, overvoltage and overload protection
Storage temperature	–40 ... + 85 °C
Ambient humidity during storage	10 % ... 95 % Rel. Humidity (non-condensing)
Ambient temperature during operation	–30 ... + 70 °C
Ambient humidity in operation	20 % ... 90 % Rel. Humidity (non-condensing)
Degree of protection	No IP assigned
Protection class	II
CE conformity / standards UL approval	RoHS-conform, EN 60950-1, EN 6155-2-16, EN50178, UL 508, UL 60950-1 EMC EMISSION EN55032 (CISPR32) Class B, EN61000-3-2 Class A, EN61000-3-3 EMC IMMUNITY EN61000-4-2, 3, 4, 5, 6, 8, 11
Mounting	DIN rail mounting: 1 TE; DIN rail TS-35 / 7.5 or TS-35/15
Control elements	1 Potentiometer
Indicator	1 LED (blue); Power-On
Line cross-section	0.5 mm ² – 2.5 mm ²
Dimension (B x H x T in mm)	17.5 x 93 x 58.4
Housing colour	Grey
Weight	80 g
Application environment	In dry closed rooms

12.33 NEA SMART 2.0 Bus Cable (10 / 50 m bundle)

Material number:

13280411001 NEA SMART 2.0 Bus Cable 10 m

13280421001 NEA SMART 2.0 Bus Cable 50 m

Functional description

Cable to connect via System Bus and Zone Bus components of NEA SMART 2.0 system.

Technical data:

Cable type	J-Y(ST)Y 2 x 2 x 0.8 mm
Conformity	DIN EN 50441, VDE 0815
Loop resistance	max. 73.2 Ohm/km
Conductor cross-section	0.8 mm
Outer diameter	7 mm
Length	10 m / 50 m
Weight	6 kg per 100 m
Ambient temperature	-5 °C ... 50 °C
Application environment	In dry closed rooms

This document is protected by copyright. All rights based on this are reserved. No part of this publication may be translated, reproduced or transmitted in any form or by any similar means, electronic or mechanical, photocopying, recording or otherwise, or stored in a data retrieval system.

Our verbal and written advice with regard to usage is based on years of experience and standardised assumptions and is provided to the best of our knowledge. The intended use of REHAU products is described comprehensively in the technical product information. The latest version can be viewed at www.rehau.com/TI. We have no control over the appli-

cation, use or processing of the products. Responsibility for these activities therefore remains entirely with the respective user/processor. Where claims for liability nonetheless arise, they shall be governed exclusively according to our terms and conditions, available at www.rehau.com/conditions, insofar as nothing else has been agreed upon with REHAU in writing. This shall also apply for all warranty claims, with the warranty applying to the consistent quality of our products in accordance with our specifications. Subject to technical changes.

www.rehau.uk

© REHAU AG + Co
Rheniumhaus
95111 Rehau

954647 EN 03.2021