



Engineering progress
Enhancing lives

PRO-BALANCE® 1 in. stainless steel manifold

Product instructions



Contents

01	Scope	3
02	Product overview	3
03	Technical data	5
04	Mounting the manifold	7
05	Installing RAUPEX pipes	8
06	Flushing and filling radiant circuits	14
07	Balancing the manifold	15
08	Isolating an individual circuit	17
09	Checking position of flow meter	18
10	Testing and maintaining the manifold	19



For updates to this publication and the most current technical instructions, safety information and manufacturer's recommendations, visit na.rehau.com/resourcecenter

1. Scope

This guide provides instruction regarding PRO-BALANCE 1 in. manifold installation and operation. Manifolds may only be installed, adjusted and maintained by an appropriately licensed installer of radiant systems.

Throughout this document, the signal word NOTICE is used to help you avoid property damage. We cannot warn of all hazards; you must also use your own good judgment.

2. Product overview

PRO-BALANCE 1 in. manifolds are used for distributing and regulating the volume of flow in radiant systems. The PRO-BALANCE 1 in. manifold is equipped with integrated flow gauge/shutoff valves and circuit balancing isolation valves which allow individual complete circuit isolation. Note the following:

- Must be operated using heating water, which is free of corrosive particles or other contaminants that can damage the manifold.
- Maximum permissible continuous operating pressure for 100% water is 87 psi (6 bar) at 180°F (82.2°C). See Fig. 2.
- Maximum permissible test pressure is 150 psi (10.3 bar) at water temperature < 86°F (30°C) and maximum ambient temperature 104°F (40°C).
- Use manifolds only as intended in order for REHAU's *PEXa Limited Warranty* to apply.

NOTICE: A damaged manifold may leak, causing system failure and property damage.

- Do not expose manifold to harmful chemicals, aggressive water conditions or any external influences that may cause damage to manifold materials.
- Use appropriate antifreeze agents when below freezing conditions exist.
- Properly insulate manifold and/or locate manifold so as to avoid condensation.
- Do not install the manifold headers using connectors or accessories made by other manufacturers.

Impact of system fluid on manifold and system components

The installer must have an understanding of local water conditions and how the makeup of the system fluid can impact the lifetime and performance of the system components. The composition of the system fluid has a major impact on the potential for corrosion within the complete system. The likelihood of corrosion and failure of system components can be greatly reduced by using suitable water quality and ensuring proper system operation.

The local installer and design engineer must have an understanding of the potential for water-side corrosion. In certain cases, various forms of corrosion can occur which include functional impairments to the system, system leakage, clogging of system components, impairment of heat transmission and flow noise.

Field experience has shown that risk of corrosion damage is greatly reduced by the following measures:

- System must be completely sealed and operated with heating water without additives. If water treatment is necessary, the contractor should ensure that the additives to the system including antifreeze, corrosion inhibitors and system flushing chemicals do not lead to corrosion of the system components.
 - Propylene glycol and ethylene-based glycols at maximum 50% concentration are recommended within temperature pressure ratings as shown in Fig. 2 in case freeze protection of system is necessary. Alcohol-based glycols are not permitted because they can lead to system failure.
 - Materials such as wax or mineral oils, threading oils or incompatible air compressor oils must not be introduced into the system.
 - Installer must review the complete list of water-contact materials in the PRO-BALANCE 1 in. manifold (see Table 1) to ensure compatibility with the flushing fluid, system fluid and additional make-up water.
 - Manifold must be installed in a non-corrosive environment.
 - If there are known local conditions that could lead to corrosion of the system components, the installer must consult with a water quality expert experienced in corrosion control of piping systems.
- If there are no known standards for ensuring proper water quality, then the German engineering standard, VDI 2035 Prevention of Damage in Water Heating Installations, should be referenced. (English version of VDI 2035 available for purchase at www.beuth.de or contact REHAU for assistance.)
- System fluid should also comply with RPA guidelines for hydronic radiant heating systems.

Manifold Components

Each PRO-BALANCE 1 in. manifold comes complete with the following:

- Installation instructions
- 1 in. NPT supply and return manifold isolation valves with gaskets and mini thermometers
- Air vent drain valves with gaskets
- Visual flow gauges/isolation valves (0-2 GPM) on supply side
- Circuit balancing/isolation valves on return side
- Mounting brackets
- Vent key with holder
- Manifold circuit chart

In addition, you will need:

- R-20 connectors for the size of RAUPEX® you are using
- 2 adjustable wrenches, one large enough to accommodate up to 1 1/2 in (38 mm)

3. Technical data

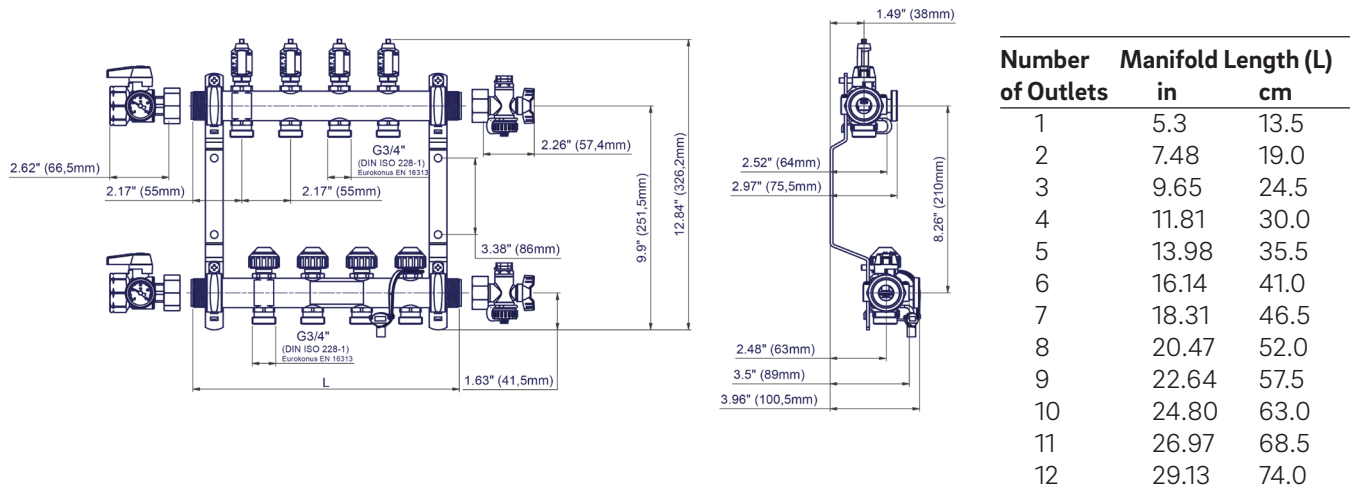

Fig. 1: Manifold dimensions

Table 1: Stainless Steel Manifold Specifications

Materials

Headers	Stainless steel DIN 1.430 (eq. ANSI 304)
Gaskets	AFM 34 synthetic fiber-based material
Isolation valves	polyoxymethylene
Air vent drain valves	Nickel-plated and chrome-plated brass, PTFE, EPDM
Circuit balancing valves	Nickel-plated brass, brass, polyamide, EPDM
Circuit inlets, outlets	Nickel-plated brass, EPDM

Connections

Header ends	1 in. BSP parallel (straight) threads
Outlets	R-20 BSP parallel (straight) outside threads
Isolation valve	1 in. NPT female threads

Temperature / Pressure Capabilities

Maximum operating temperature for 100% water	180°F (82.2°C) @ 87 psi (6 bar), see Fig. 2.
Minimum operating temperature	14°F (-10°C) @ 145 psi (10 bar), see Fig. 2.
Maximum water test pressure (for 24 hrs < 86°F (30°C) @ max. ambient temperature 104°F (40°C))	150 psi (10.3 bar)
Maximum allowable differential pressure	44 psi (3 bar)

Flow Rates

Maximum flow rate	2.0 USGPM per circuit; 20 USGPM total (0.13 l/s per circuit; 1.27 l/s total)
-------------------	---------------------------------------------------------------------------------

NOTICE: Exposure to some fluids may damage manifold materials. Contractor must confirm compatibilities of system fluids such as antifreeze, corrosion inhibitors and system flushing chemicals with water contact components of manifolds.

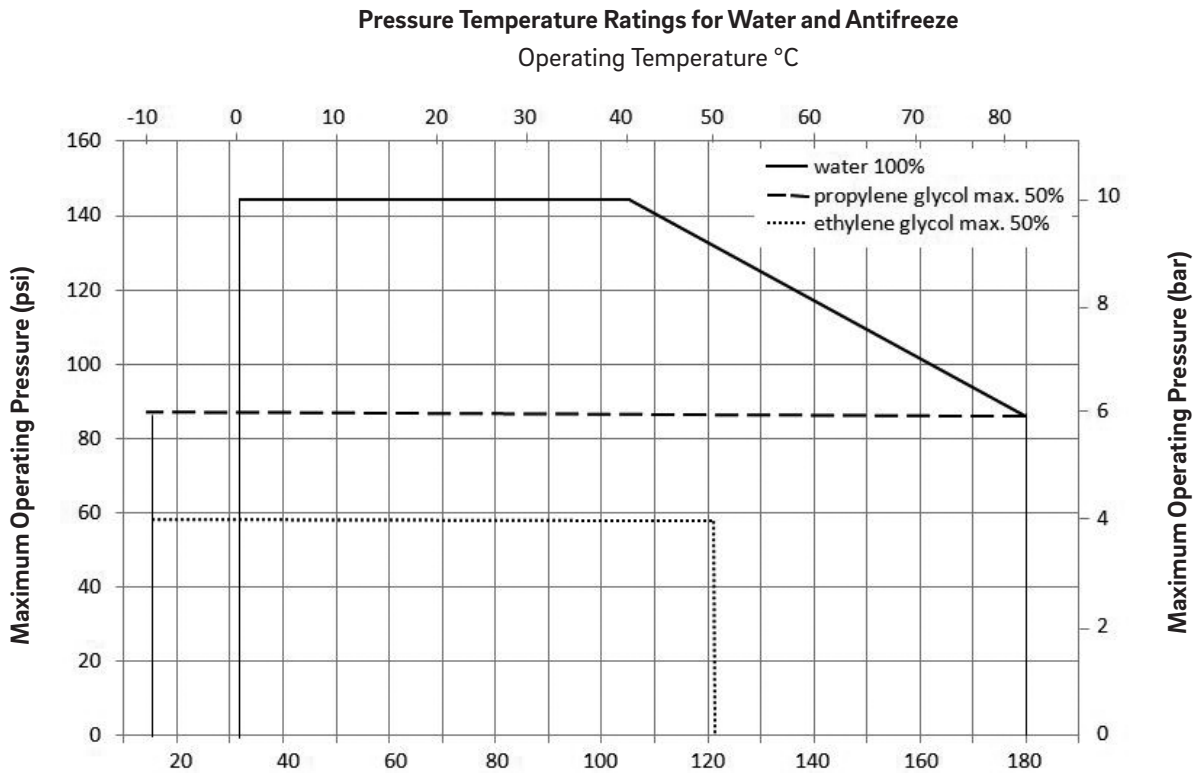

Fig. 2: Manifold temperature and pressure capabilities for different system fluids
 Note: Operating temperature and pressure must stay below corresponding line for appropriate fluid type.

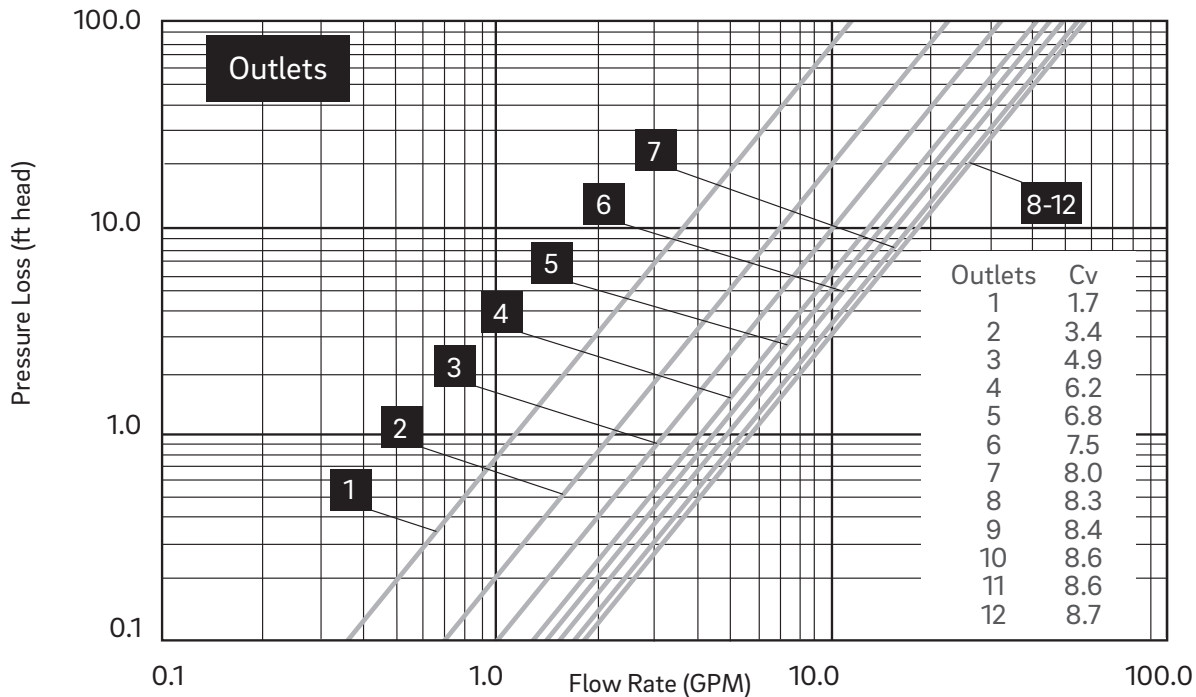

Fig. 3: Pressure loss through manifold
 Note: The numbered boxes shown above indicate the number of outlets on the manifold.

To use the diagram in Fig. 3, choose the flow rate that is the total flow rate for the entire PRO-BALANCE 1 in. manifold – the total of all circuits (e.g., 3 GPM). Plot a vertical line upwards to intersect with the line for the size of the manifold (e.g., 3 outlets). From that point, move to left to find pressure loss in feet of head (e.g., 3 GPM, 3 outlets = 0.9 ft. head). This is the total pressure (head) loss through the manifold’s header pipes, the 1 in. isolation valves, the circuit balancing valves (when fully open) and the flow gauges.

4. Mounting the manifold

NOTICE: An improperly installed manifold can leak, causing system failure and property damage. To minimize risk of leaks:

- Must use included steel mounting brackets, which provide a secure mount, proper alignment and isolation of vibration and noise.
- Do not use thread sealant tape or pipe dope on the manifold outlets.
- Do not over tighten connections.

1. Install the manifold in its final position prior to connecting the RAUPEX pipes.
 - Manifold may be installed in a REHAU steel heating manifold cabinet, on a wall or on a temporary support frame.
 - Manifold may be mounted in any orientation (i.e., inverted, horizontal, sideways).
 - Manifold must be level and have adequate clearance on the sides for pipe connections.
 - Minimum clearance is 16 in (40 cm) between the bottom of the manifold and the top of the finished floor.
 - Steel mounting bracket and screws are provided.
2. Attach the 1 in. isolation ball valves and the air vent drain valves by sliding the flange nut over the large tab on the flange, then over the small tab. Hand tighten the nut onto the end of the header.
 - Red-handle valve goes on the supply header.
 - Blue-handle valve goes on the return header.
 - Use the slip flanges and flat gaskets provided.
 - Align valves with the thermometer housings facing the front.

Note: If you will be using an air test, slightly wet the flat gaskets with water before attaching each valve.

3. Gently tighten the nuts with a 1 7/16 in (36 mm) wrench, without crushing the flat gaskets (1/4 to 1/2 turn).
4. Close the 1 in. isolation valves for pressure testing and to keep out foreign objects.

5. Installing RAUPEX pipes

RAUPEX pipes are connected to the manifold using REHAU EVERLOC+ compression-sleeve fitting system R-20 manifold outlets or compression nut fitting system R-20 manifold outlets (sold separately from PRO-BALANCE manifolds).

It is easiest to connect each pipe to the manifold working left to right and starting with the upper (supply) header first.

Note: If using PVC bend guides, make sure guides are slid over pipe and adjusted to the proper height before attaching the R-20 connector.

5.1 EVERLOC+ compression-sleeve fitting system R-20 manifold outlet connection instructions.

These swivel nut connections install onto PRO-BALANCE manifolds with two standard wrenches. Installation of RAUPEX pipe is performed with EVERLOC+ compression-sleeve tools. All fitting sizes include EVERLOC+ insert with installed O-ring and swivel nut in one assembly. EVERLOC+ PEXa compression sleeves separately.

1. Push the conical end of the R-20 connector all the way into the appropriate outlet of the manifold.

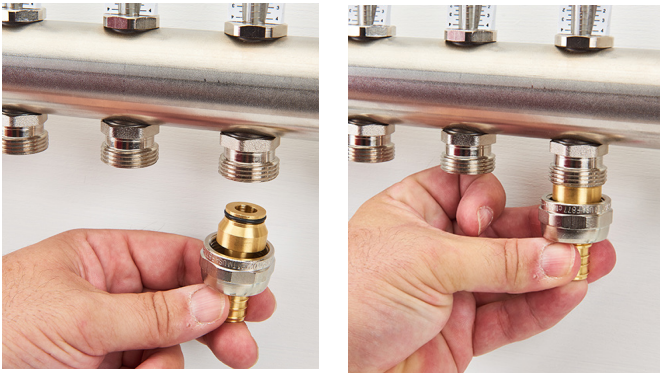

2. Hand tighten the swivel nut, making sure the fitting is pushed all the way in the outlet

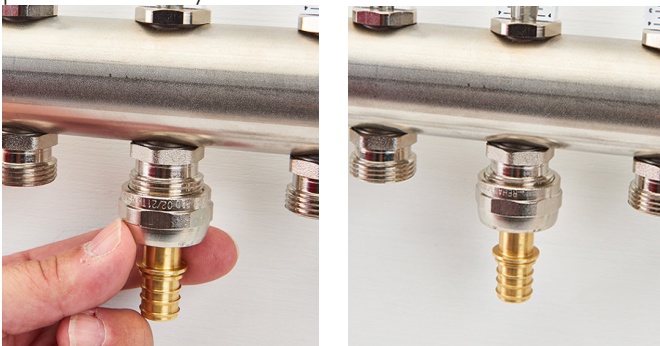

NOTICE: Do not use thread sealant tape or pipe dope on manifold outlets. These materials may prevent a proper seal, causing leaks.

3. While holding the hex end of the manifold outlet with an adjustable wrench, use another wrench to turn the swivel nut to snug tight to ensure proper seal (no more than 9 ft-lb or 12 N-m). Use a 1 1/4 in (32 mm) wrench for all sizes



NOTICE: Do not over tighten. This will damage the manifold outlet or O-ring, causing leaks.

4. Using the top of the EVERLOC+ fitting collar as a reference for proper length, mark pipe with marker and cut squarely with pipe cutter.

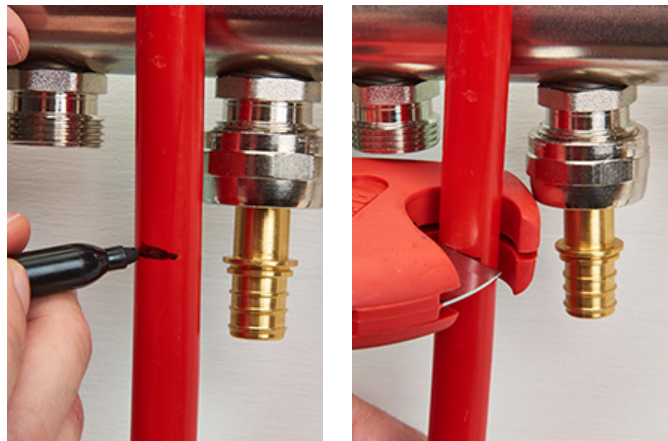

5. Slide the EVERLOC+ PEXa compression sleeve onto the RAUPEX pipe.

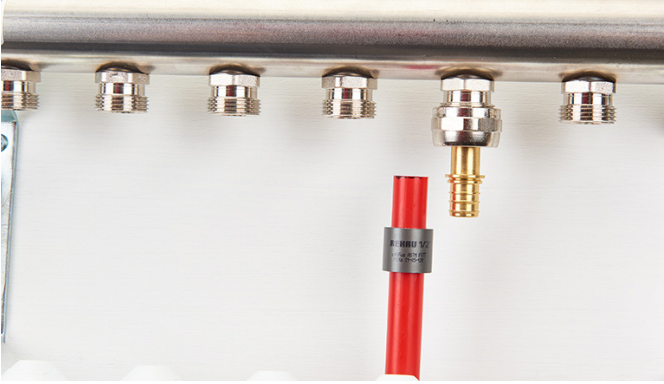

6. Expand pipe using the EVERLOC+ Power Tool

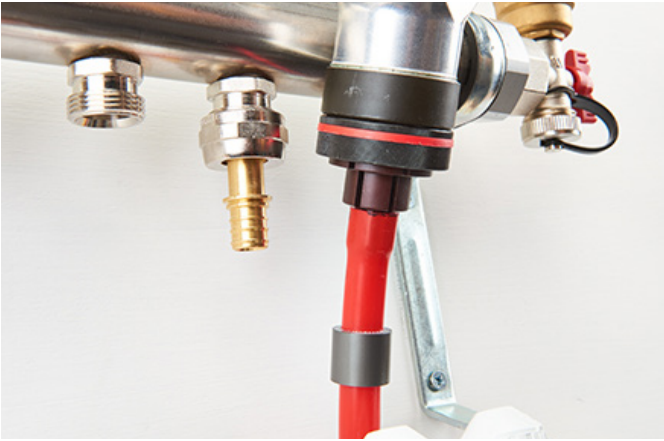

Note: Follow all published REHAU *Technical Guidelines* for expansion and compression with the EVERLOC+ Power Tool.

7. Slide pipe onto R-20 fitting and compress the sleeve onto the fitting.

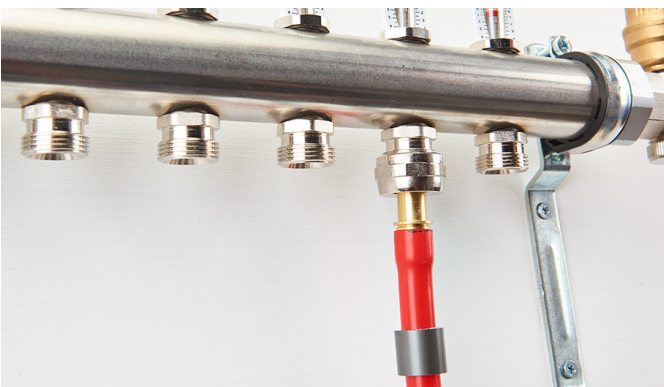

8. Repeat steps 1-7 for all outlet connections. If there are unused circuit outlets on the manifold, use the R-20 Circuit Outlet Cap (Art. No. 250209-C).

NOTICE: Do not use damaged R-20 connectors or rubber O-rings. Damaged parts may cause leaks.

5.2 Compression nut fitting system R-20 manifold outlet connection instructions for 3/8, 1/2, and 5/8 RAUPEX pipe.

Note: for 3/4 in. pipe connections, see section 5.3.

1. Cut pipe squarely using a pipe cutter.

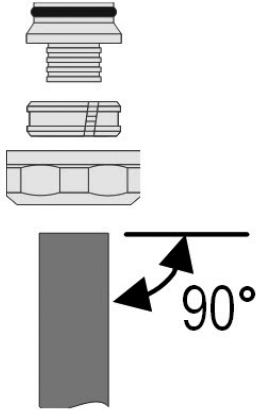

2. Slide the R-20 compression nut and split ring over the pipe. Then push in the insert fitting all the way to the top of the pipe.

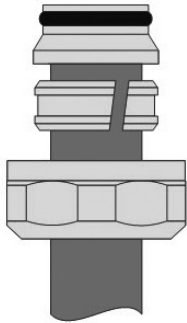

NOTICE: Do not use any damaged R-20 connectors or rubber O-rings. Damaged parts may cause leakage.

3. Push the conical end of the R-20 connector all the way into the appropriate outlet of the manifold.

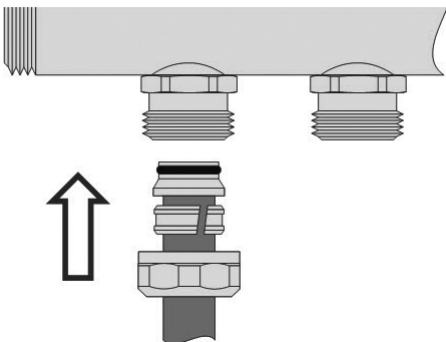

4. Hand tighten the compression nut, making sure the pipe and fitting are pushed all the way in.

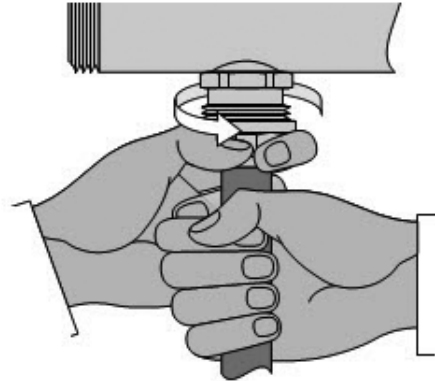

NOTICE: Do not use thread sealant tape or pipe dope on the manifold outlets. These materials may prevent a proper seal, causing leaks.

5. While holding the hex end of the manifold outlet with an adjustable wrench, turn the compression nut no more than a half turn beyond hand tight.

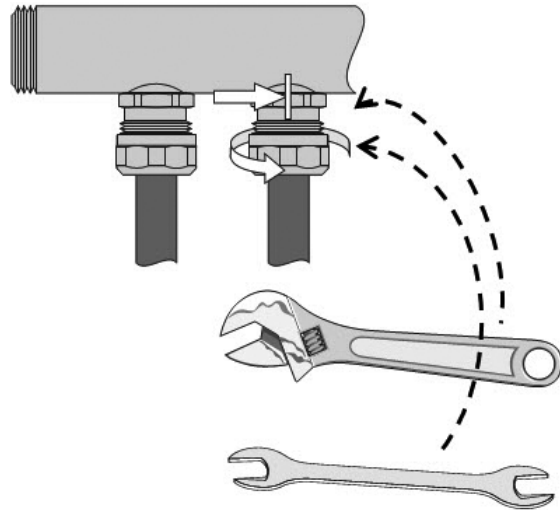

- For 3/8, 1/2 and 5/8 in. connections, use a 1 1/4 in (32 mm) wrench.

NOTICE: Do not over tighten. Use approximate force of 12 Nm or 9 lb ft. Over tightening will damage the O-ring or the manifold outlet, causing leaks.

6. Repeat steps 1-5 for all outlet connections. If you have unused circuit outlets on the manifold, use the R-20 Circuit Outlet Cap (Article No. 250209-C).

5.3a Compression nut fitting system R-20 manifold outlet connection instructions for 3/4 in. RAUPEX pipe.
Installation for article no. 418319-001 only.

Compression nut fitting system R-20 manifold outlets for 3/4 in. RAUPEX pipe require an R-20 x 1 in. NPS bushing for installation. (Bushing included in 3/4 in. R-20 manifold outlet packaging.)

1. Cut pipe squarely using a pipe cutter
2. Slide the compression nut and split ring over the end of the pipe.

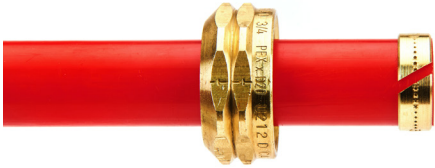

3. Inset the 3/4 in. barbed insert into the pipe firmly, ensuring the fitting collar sits flush with the pipe.



4. Push the split ring up the pipe to meet the barbed insert collar.

NOTICE: Failure to position the split ring firmly against barbed insert collar will not allow the compression nut to be threaded onto the bushing in Step 6.

5. Thread the R-20 x 1 in. NPS bushing hand tight onto the PRO-BALANCE manifold outlet



6. Insert the 3/4 in. barbed insert with installed O-ring into the bushing. Push firmly until fully inserted.

7. Slide the compression nut up the pipe and thread onto the bushing.

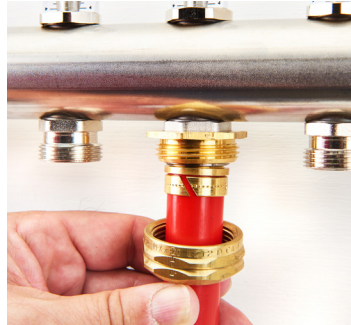

8. Use two wrenches to tighten. One to hold the bushing and the second to tighten the compression nut to 12 Nm or 9 lb. ft. This is approximately 1/2 turn from hand tight.

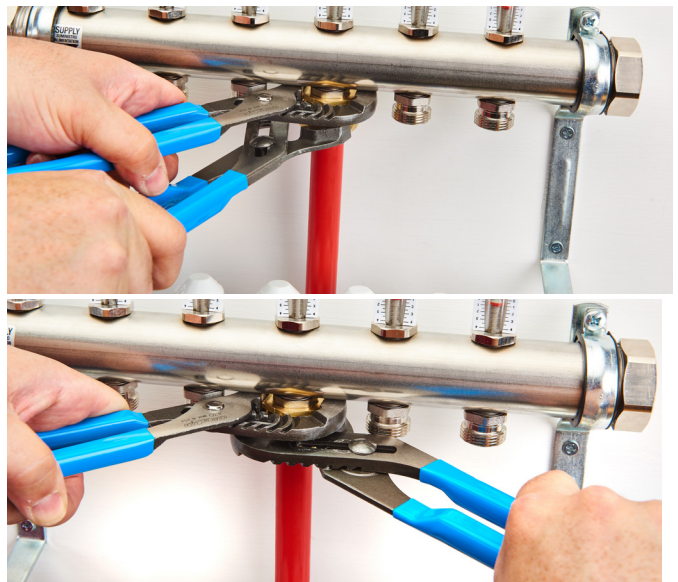

NOTICE: Do not overtighten. Overtightening may distort the split ring or crack the manifold outlet, causing a leak.

NOTICE: Do not use thread sealant tape or pipe dope on manifold outlets. These materials may prevent a proper seal, causing a leak in the connection.

5.3b Compression nut fitting system R-20 manifold outlet connection instructions for 3/4 in. RAUPEX pipe.
Installation for article no. 418319-002 only.

Compression nut fitting system R-20 manifold outlets for 3/4 in. RAUPEX pipe require an R-20 x G 7/8 bushing for installation. (Bushing included in 3/4 in. R-20 manifold outlet packaging.)

1. Cut pipe squarely using a pipe cutter
2. Slide the compression nut and split ring over the end of the pipe.



3. Place the bushing on the end of the pipe with the male threads orientated towards the compression nut.
4. Insert the 3/4 in. barbed fitting body into the pipe firmly through the bushing, ensuring the fitting body sits flush with bushing. There should be little to no play between the bushing and fitting body.



5. Thread the bushing hand tight onto the PRO-BALANCE manifold outlet.



6. Use two wrenches to snug the bushing to the manifold outlet. One to snug the bushing and the second to hold the manifold outlet to prevent damaging the outlet stem.



7. Push the split ring up the pipe to meet angled surface of the bushing.



NOTICE: Failure to position the split ring firmly against barbed insert collar will not allow the compression nut to be threaded onto the bushing in step 8.

8. Use two wrenches to tighten. One to hold the bushing and the second to tighten the compression nut to 12 Nm or 9 lb. ft. This is approximately 1/2 turn from hand tight.

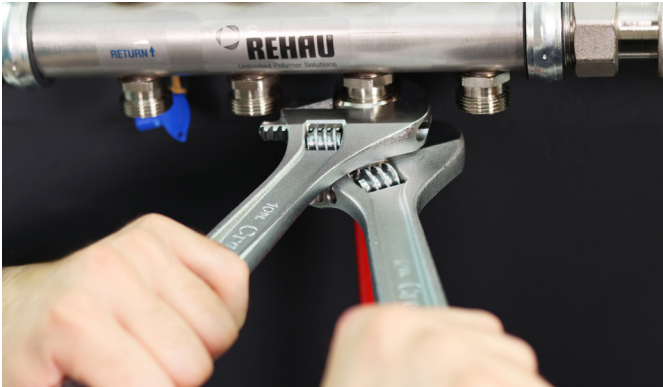

NOTICE: Do not overtighten. Overtightening may distort the split ring or crack the manifold outlet, causing a leak.

NOTICE: Do not use thread sealant tape or pipe dope on manifold outlets. These materials may prevent a proper seal, causing a leak in the connection.

6. Flushing and filling radiant circuits

Use the manifold air vent ball drain combination set (Art. 316257-002, not included) to fill, purge and bleed the system. Threaded connection is for 3/4 in. garden hose threads.

Note: System must be filled through the supply header and drained through the return header.

To fill and purge the system:

1. Close the 1 in. ball valves on the supply and return headers.
2. Make sure all flow meters are completely open by turning the vent key counter clockwise.
3. Close all balancing valves by turning the protective cap clockwise.
4. Open each drain valve by turning the handle 90° degrees to be aligned with the valve body.
5. Attach a garden hose to each valve.
6. Turn on supply of water and begin filling manifold.
7. Open the first circuit balancing valve and flow water until no more air comes out.
8. When this circuit is purged, close the circuit balancing valve and repeat this process for the remaining circuits.
9. When purging is complete, close the return drain valve first, then close the supply drain valve.
10. Remove hoses and re-install the protective caps.

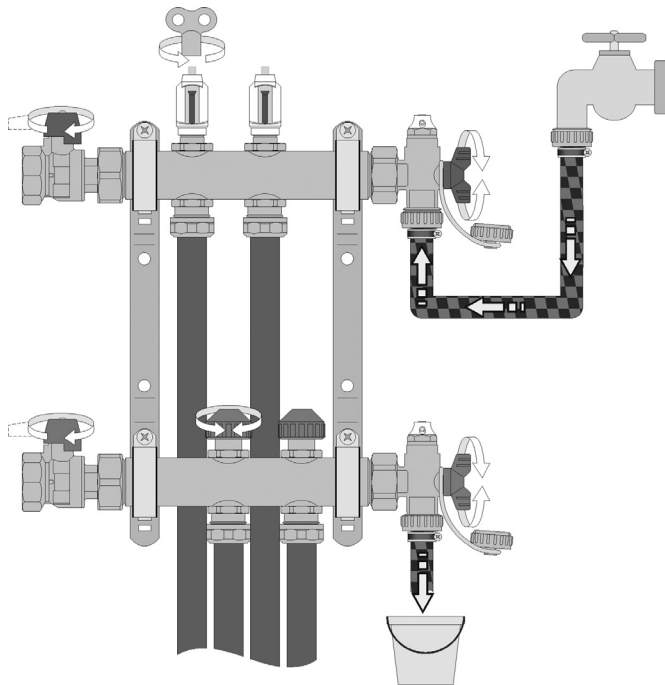

The manual air vent on the top of each valve may be used to bleed trapped air from the system. These manual air vents may be replaced with the automatic air vent (sold separately) for automatic venting of trapped air.

Operation of manual air vents:

1. To open the air vent, turn the square portion of the valve with the 1/4 in. vent key at least half turn.
2. Turn the white housing by hand to aim the air, mist or fluid that comes out.
3. When air is bled from the system, close the air vent by turning it clockwise.

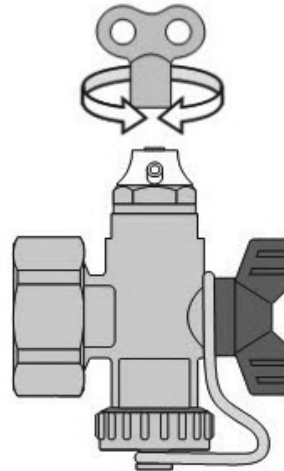

NOTICE: Make sure air vent is completely closed after system is bled. If vent is not closed, valve will leak.

7. Balancing the manifold

The circuit shutoff and balancing valves are located on the return header.

1. Remove protective cap of the circuit balancing valve and close the valve by turning the vent key clockwise until it stops. This should shutoff the circuit 100%.

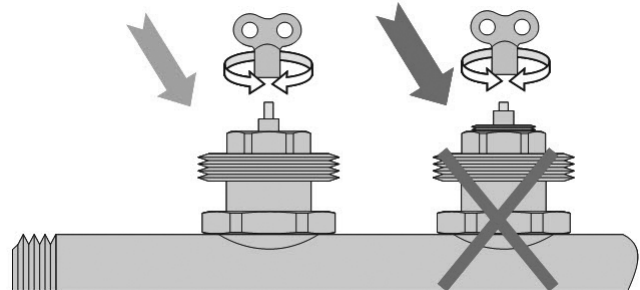
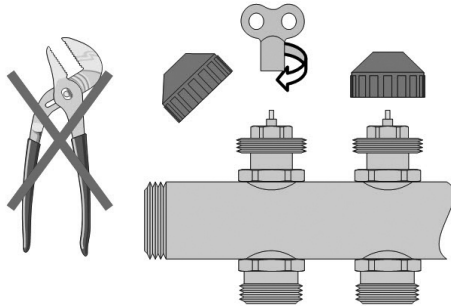

NOTICE: The valve is fully opened with 2 1/2 to 3 counterclockwise turns. Do not allow the fine thread of the control spindle to project above the hexagon nut or leakage will occur.

2. Set the circuit flow (GPM) by turning the control spindle counterclockwise.
 - Start with the circuit valve with the lowest flow requirement and set to the required flow plus approximately 50%.
 - Read the actual value from the corresponding flow meter on the supply header.

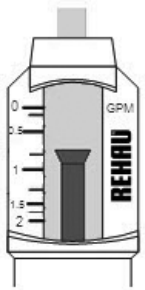
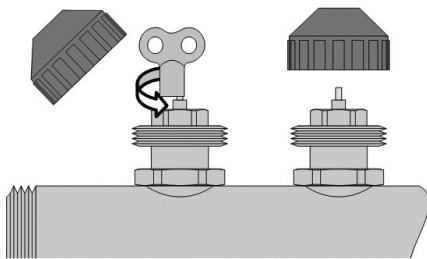

- i.e. approximately 0.75 GPM flow rate
3. Proceed by adjusting the remaining circuit valves.

4. After setting all circuit valves, check the flow values on the flow meter of all circuits. Readjust as necessary.
 - To reduce flow, turn the circuit valve clockwise.
 - To increase flow, turn the valve counter clockwise.
 - Turn the valve slowly to see the change in flow on the flow gauge.

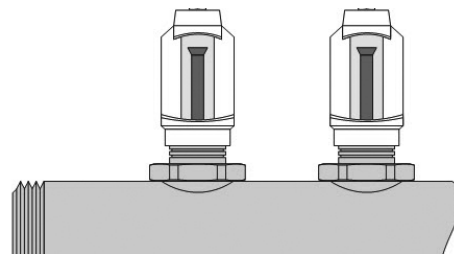
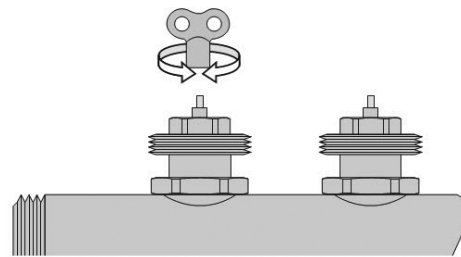

Note: Do not allow the fine thread of the control spindle to project above the hexagon nut or leakage will occur.

1. After balancing the manifold, thread the protective cap back on a half turn.
 - The cap prevents the valves from accidental adjustment and from getting dirty.
 - Threading the cap completely on will close the valve, but it will not change the initial balancing adjustment of the valve.

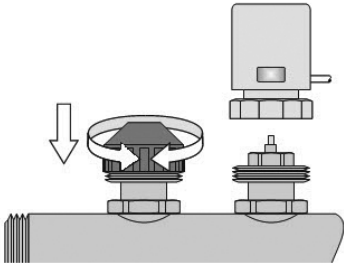

If you are using manifold actuators, mount these in place of the white caps.

2. Complete the PRO-BALANCE Manifold Circuit Chart and post it next to the manifold.

PRO-BALANCE® Manifold **REHAU**
 Circuit Chart

Circuit no.	Room name	Pipe size	Starting footage	Ending footage	Circuit length	Design flow rate
1						
2						
3						
4						
5						
6						
7						
8						
9						
10						
11						
12						

Installer information

Installer _____ City/State _____

Street address _____ Additional address _____

City/State _____ Flushing water mixture _____

Phone no. _____ System test date _____

Fluid information

For details on the installation of this manifold, please refer to the REHAU technical manual. The manufacturer guarantees the accuracy of any data and does not assume any liability for personal or professional use. The user will be responsible for any damage caused by the use of this product. © 2011 REHAU
 850-220-16-AJ-01

8. Isolating an individual circuit (if required)

The PRO-BALANCE 1 in. manifold allows for complete isolation of individual circuits by using the shutoff valve integrated within the flow meter on the supply header and corresponding balancing valve on the return header..

To close a circuit:

Note: Check to see if all flow is stopped to the manifolds. All circulators should be off and all systems make-up water should be turned off as well.

1. On the return header, close the circuit balancing valve by turning the cap clockwise until it stops. If the circuit has a REHAU valve actuator installed, replace it with the protective cap.

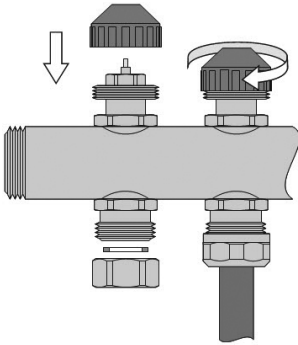

Note: Do not use the vent key to close the circuit as this will change the balancing of the system

2. On the corresponding flow meter, use the vent key to turn the shutoff valve clockwise until it stops.

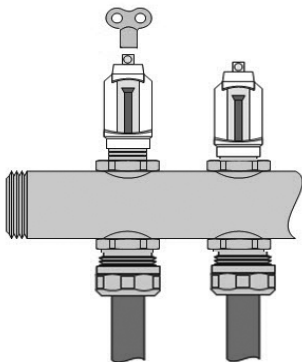

NOTICE: The flow meter should not be used for adjusting flow. The flow meter should be completely open during filling and purging the circuits as well as during normal operation mode.

Note: For permanent shut-off, attach an R-20 brass circuit outlet cap with gasket to the manifold outlet. Also, ensure balancing valve and flow meter shutoff valve are completely closed.

To open a closed circuit:

Note: Check to see if all flow is stopped to the manifolds. All circulators should be off and all systems make-up water should be turned off as well.

1. To reopen a circuit, turn the flow meter with the vent key counterclockwise until it stops and turn protective cap counterclockwise to release cap from the valve.

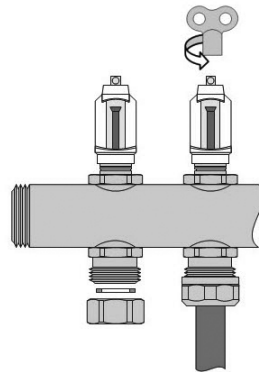

2. If you are using a manifold actuator, completely remove the cap, then reinstall manifold actuator. If you are not using a manifold actuator, thread the protective cap back

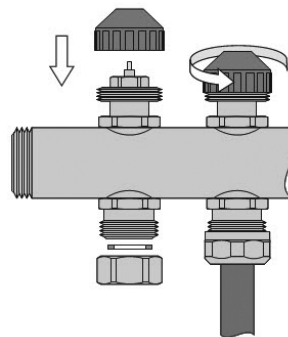

Note: Be sure circulators are turned back on and system make-up water is turned back on as well

9. Checking position of flow meter shutoff valve

To verify that the flow meter with integrated shutoff valve is fully open:

- Place the vent key completely on top of the flow meter and check that the top of the white housing is flush with the bottom of the vent key. If not, simply slide the white housing up so that it is flush with the bottom of the vent key.
- When the flow meter shutoff valve is fully open, the distance between the white scale and the hex is approximately 1/4 in (6 mm). In addition the groove underneath the white scale is visible.

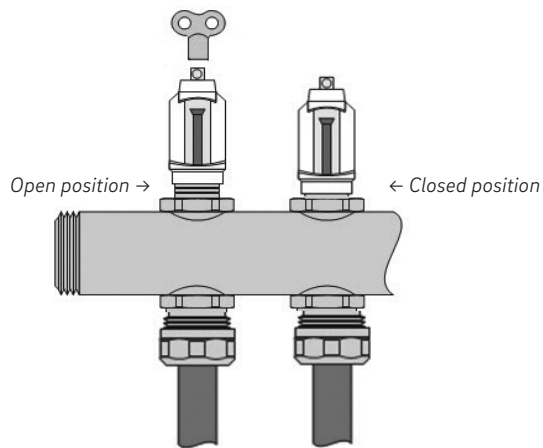

10. Testing and maintaining the manifold

Once installation of manifold and pipes is complete, the system should be pressure tested with air or water to ensure there are no leaks.

The manifold should be inspected periodically during system operation to ensure none of the connections have loosened or are leaking.

For updates to this publication, visit na.rehau.com/resourcecenter

The information contained herein is believed to be reliable, but no representations, guarantees or warranties of any kind are made as to its accuracy, suitability for particular applications or the results to be obtained therefrom. Before using, the user will determine suitability of the information for user's intended use and shall assume all risk and liability in connection therewith. © 2024 REHAU

855.663 06.2024