



REHAU®

Unlimited Polymer Solutions



UNDERFLOOR HEATING FLOOR SYSTEMS INSTALLATION GUIDE

UNDERFLOOR HEATING FLOOR SYSTEMS

TABLE OF CONTENTS

1	REHAU RAUTHERM Universal Pipe	pg7
2	General System Components and Accessories	pg11
3	Manifolds and Cabinets	pg19
4	Circuit Laying Patterns	pg27
5	Floor Installation Systems	pg31
6	Special Applications	pg57
7	Compression Sleeve Joints	pg63
8	ScreeDs and Floor Coverings.	pg67
9	Commissioning	pg71
10.	Frequently Asked Questions	pg81

REHAU RAUTHERM
Universal Pipe

General System
Components

Manifolds and
Cabinets

Circuit Laying
Patterns

Floor Installation
Systems

Special
Applications

Compression
Sleeve Joints

ScreeDs and
Floor Coverings

Commissioning

Frequently Asked
Questions

UNDERFLOOR HEATING FLOOR SYSTEMS

INTRODUCTION

1 REHAU Tacker Sheet System



The REHAU underfloor heating systems are currently providing cost-effective comfort and safety in a variety of installations across the world, including offices, factories, care facilities and community centres. Wherever you install it, the system you choose is tailored to suit the space and its occupants. REHAU underfloor heating provides the right amount of heat in the right place at the right time.

REHAU has a reputation for excellence. It has been earned by providing the building and construction industry with high quality products, expertise and customer support for over 40 years. It's a reputation we aim to maintain.

REHAU offer a national distribution network ensuring that you can obtain product with ease and at your convenience. Please contact your local REHAU sales office for further details.

REHAU offer a wide range of underfloor heating system options to suit any requirement and this manual will guide you through the different systems available, and the installation process.



- 2** REHAU RAUFIX/Railfix System
- 3** REHAU Diffusion Plate System
- 4** REHAU Floating Floor System
- 5** REHAU Sprung Floor System

Floor systems featured in this manual:

REHAU Tacker Sheet System

A system where significant time and costs savings are achievable during installation by combining previously separate installation steps into one.

REHAU RAUFIX/Railfix System

This system ensures that uniform circuit patterns are easily achieved and simplifies the installation process in large areas. The underfloor heating circuits may be laid in the double meander pattern, which gives an even spread of heat.

REHAU Diffusion Plate System

Designed specifically for timber joist floor applications.

REHAU Floating Floor System

This dry system is ideal for installations where a finished floor is required within a minimum time frame. No wet trades are involved, making it a very fast system to install and removes the need for other building trades.

REHAU Sprung Floor System

This system is ideal for installations in areas where an impact resilient floor is required and which are predominantly used for physical activities, such as sports halls.

**REHAU also supply the following system:
- Industrial/Structural Systems.**

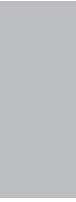

1. REHAU RAUTHERM UNIVERSAL PIPE

TABLE OF CONTENTS

An Introduction to REHAU RAUTHERM Universal Pipe	
REHAU Materials Specification	pg8
Pipe Specification	pg8
Transport and Warehousing	pg9
Pipe Bending and Kinking.	pg9
Component Selection Table	pg9
Technical Data	pg10
Delivery Make-up	pg10

1. AN INTRODUCTION TO REHAU RAUTHERM UNIVERSAL PIPE



REHAU Materials Specification

REHAU RAUTHERM universal pipe is made from Cross-Linked Polyethylene, with a co-extruded EVAL oxygen diffusion barrier.

Cross-linking is the process of linking molecules in the polyethylene, giving much improved physical properties. REHAU was one of the pioneers of this process.

The EVAL Oxygen diffusion barrier completely surrounds the base pipe and prevents the entry of oxygen into the system through the pipework. This significantly reduces the risk of corrosion damage to ferrous components in the heating system. The EVAL barrier is highly resistant to abrasion and is notch resistant and thus capable of withstanding rough treatment on site.

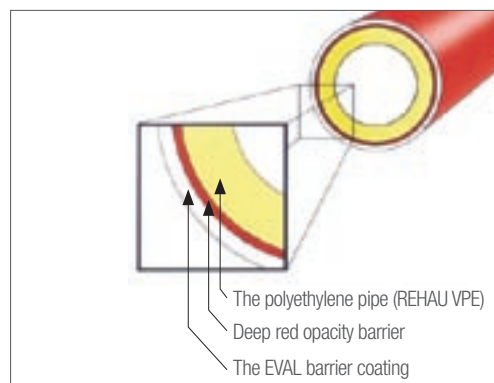

REHAU RAUTHERM universal pipe is supplied in sizes:

- 16 x 1.5mm
- 20 x 1.9mm.

REHAU RAUTHERM universal pipe has exceptional physical properties including:

- Resistance to stress crack formation
- Outstanding long-term stress rupture resistance at high temperatures, up to 105°C
- Exceptional thermal ageing resistance
- Kink resistance and kink damage resistance
- Chemical resistance and completely non-corroding
- Resistance to scale build-up.

Pipe Specification

REHAU RAUTHERM universal pipe and the underfloor heating system are fully tested to BS 7291, listed in the WRAS (Water Regulations Advisory Scheme) directory and are BBA approved.



- Working pressure - 6 bar at 95°C - BS 7291
- Maximum flow temperature 105°C at 3 bar
- Recommended for nominal flow temperatures up to 83°C
- Operating pressure of 3.5 bar complying to Class S.

Transport and Warehousing

The REHAU RAUTHERM universal pipe and all system components should be transported and stored under expert supervision. The pipe should be protected from damage, oils, fats, dyes, long-term exposure to sunlight and should be stored on a flat support surface free from any sharp edges. If stored in unprotected conditions, storage period should not exceed three months.

Pipe Bending and Kinking

REHAU RAUTHERM universal pipes are flexible and can be laid 'cold'. The minimum bending radii are:

- (5 x D) at > 0°C
- (3 x D) at 130°C.

(D= pipe's external diameter).

A kinked pipe can be repaired by gently and evenly applying heat to a length of 300mm each side of the kink.

Care must be taken to keep the heat source (e.g. hot air gun, blow torch) constantly moving in order to avoid local overheating of the pipe.

After about 3 to 5 minutes, the pipe will start to recover. Apply heat until the bore is fully recovered.

Where the absolute minimum bending radius of 3 x D is required, heat should be applied as described above and then form the bend carefully.



Avoid overheating the pipe at all times.

When finished check that there is no damage to the glossy outer EVAL layer of the pipe.

Component Selection Table

Components	16 x 1.5mm Art. No. 136430	20 x 1.9mm Art. No. 136450
REHAU Tacker Sheet System	Y	Y
REHAU RAUFIX/Railfix System	Y	Y
REHAU Diffusion Plate System	Y	N
REHAU Floating Floor System	N	Y
REHAU Sprung Floor System	N	Y

REHAU also provide the following system:-
- Industrial/Structural floor system
For further information please contact your local REHAU sales office.

1. REHAU RAUTHERM UNIVERSAL PIPE

TECHNICAL DATA

Technical Data

Property	Tested to:	Value	Units
Density	DIN 53497	0.93	g/cm ³
Young's modulus	DIN 53457	~ 600	N/mm ²
Impact resistance At +20°C At -20°C	DIN 53457	without breaking without breaking	
Linear expansion co-efficient At +20°C At 100°C		1.4 x 10 ⁻⁴ 2.0 x 10 ⁻⁴	/K ⁻¹ /K ⁻¹
Thermal conductivity		0.35	W/mk
Oxygen permeability At 40°C		≤0.1	mg/l d
Pipe roughness k		0.007	mm

Delivery Make-up

Make-up	16 x 1.5mm Art. No. 136430	20 x 1.9mm Art. No. 136450
100m coil	Y	Y
200m coil	N	Y
240m coil	Y	N
490m coil	Y	N
500m coil	N	Y

2. GENERAL SYSTEM COMPONENTS AND ACCESSORIES

TABLE OF CONTENTS

Corrugated Sleeve	pg12
EPS Floor Insulation	pg12
Edge Insulation	pg13
PE (Polyethylene) Membrane	pg14
Expansion Joint Profile	pg14
Adhesive Tape and Dispenser	pg15
Pipe Cutters	pg15
Pressure Pump	pg15
Pipe Unwinder	pg16
Pipe Retaining Rail and Fixing Lugs.	pg17
90° Pipe Bend Former	pg17

2. GENERAL SYSTEM COMPONENTS AND ACCESSORIES



Corrugated Sleeve

To protect RAUTHERM universal piping where pipes are fed into the distribution manifold, routed across movement joints, through walls and changes in level.

Delivery Make-up		
Art. No.	137140	137150
Coil length	50m	50m
Weight	3.9kg	4.6kg
Pipe size	ø16	ø20

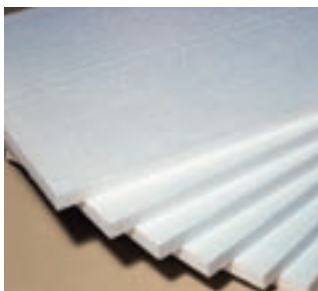

EPS Floor Insulation

REHAU EPS insulation is made from CFC free polystyrene and meets the new European manufacturing standard EN 13163.

Can be used as additional insulation for:

- REHAU RAUFIX/Railfix System
- REHAU Tacker Sheet System
- REHAU Diffusion Plate System.

REHAU EPS floor insulation is supplied in two grades:

- EPS 70
- EPS 100.

Technical Data	EPS 70 25mm	EPS 70 50mm	EPS 100 25mm	EPS 100 50mm
REHAU Art. No.	264195	264205	264175	264185
Dimensions in mm (Length x Width x Thickness)	2400x1200x25	2400x1200x50	2400x1200x25	2400x1200x50
Thermal conductivity	0.038 W/mK	0.038 W/mK	0.036 W/mK	0.036 W/mK
Compression strength 10%	> 70 kPa	> 70 kPa	> 100 kPa	> 100 kPa
Cross breaking strength	> 115 kPa	> 115 kPa	> 150 kPa	> 150 kPa
Fire class	F	F	F	F
Full designation to EN 13163	EPS 70- EN13163-T1-L1- W1-S2-P3 DS(80,-)1	EPS 70- EN13163-T1-L1- W1-S2-P3 DS(80,-)1	EPS 100- EN13163-T1-L1- W1-S2-P3 DS(80,-)1	EPS 100- EN13163-T1-L1- W1-S2-P3 DS(80,-)1

Delivery Make-up	EPS 70 25mm	EPS 70 50mm	EPS 100 25mm	EPS 100 50mm
REHAU Art. No.	264195	264205	264175	264185
Pack size	12 boards	12 boards	12 boards	6 boards
Area coverage	34.56m ²	17.28m ²	34.56m ²	17.28m ²
Packaging	Shrink wrapped	Shrink wrapped	Shrink wrapped	Shrink wrapped

Edge Insulation

The profiled PE (Polyethylene) wall of the REHAU insulation strip allows for easy fitting to walls, corners, projections and recesses. It also helps to reduce heat bridging and offers the required movement of 5mm for heating screeds according to DIN 18560.

The adhesive strip on the back of both the insulation and clear foil flap guarantee excellent adhesion and quick assembly.

The foil base is tear resistant and also prevents moisture and water from the screed reaching the EPS floor insulation.

Suitable for:

- REHAU Tacker Sheet System
- REHAU RAUFIX/Railfix System
- REHAU Floating Floor System.

Assembly

1. Remove the protective film from the adhesive strip on the back of the edge insulation.
2. Fit the edge insulation around the perimeter of the room with the REHAU logo uppermost.
3. When the EPS floor insulation has been laid, pull off the protective film from the adhesive strip on the foil flap and stick down firmly.



All edge insulation joints must have an overlap of 5cm.



Delivery Make-up	
Art. No.	264411
Coil length	25m
Weight	1.2kg

Technical Data	
Material wall	PE (Polyethylene)
Material foil flap	PE (Polyethylene)
Height	180mm
Gauge	10mm
Length foil flat	280mm

2. GENERAL SYSTEM COMPONENTS AND ACCESSORIES



PE (Polyethylene) Membrane

The REHAU PE (Polyethylene) membrane is tear resistant and meets the requirements set out for DIN 18560. It prevents moisture and water from the screed reaching the EPS floor insulation and therefore reduces heat bridging.



If used with an anhydride (flow) screed, all joints must have an overlap of at least 80mm or must be taped in accordance with BS 1264.

Delivery Make-up	
Art. No.	256054
Coverage	120m ²
Weight	29kg
Thickness	800 gauge / 0.2mm



Expansion Joint Profile

The REHAU Expansion Joint Profile can be used to achieve an elastic joint between and on the perimeter of heated screed slabs. A self adhesive strip on the bottom of the profile provides a quick and safe method of fixing the rail onto the REHAU EPS floor insulation. (For further information on the REHAU Expansion Joint Profile, see page 69).

Suitable for:

- REHAU Tacker Sheet System
- REHAU RAUFIX/Railfix System.

Assembly

1. Cut 300mm long pieces of corrugated sleeve, split them along their length and clip them over the pipe where the profile is installed.
2. Cut out holes in the profile for the pipe and sleeve.
3. Remove protective cover from base of profile.
4. Fit profile over pipes onto the EPS floor insulation, securing the profile firmly down.

Delivery Make-up	
Art. No.	239243
Quantity	20 x 1.2m
Weight	0.120kg

Technical Data	
Material wall	PE (Polyethylene)
Material foil flap	PVC-U
Height	100mm
Gauge	~ 11mm
Length	1.2m

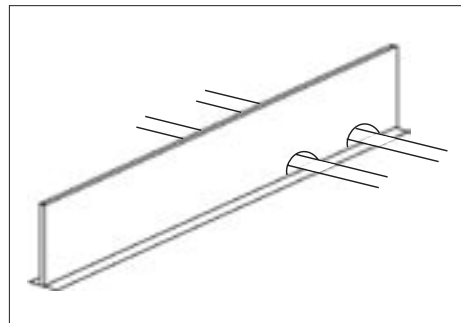

Adhesive Tape and Dispenser

- High level of adhesion
- High degree of tear resistance
- Light weight tape dispenser.

Suitable for:

- REHAU Tacker Sheet System
- REHAU RAUFIX/Railfix System.



The REHAU tape should be used with every Tacker Sheet system and anhydride (flow) screed.



Delivery Make-up	
Art. No.	265942
Roll	66m
Width	50mm



Delivery Make-up	
Art. No.	261959
Quantity	1 piece
Weight	0.397kg

Pipe Cutters

Available with quick-action or ratchet mechanism.

- Quick and safe cutting action
- Burr free cut faces.

Suitable for:

- RAUTHERM universal pipe 16 x 1.5mm up to 40mm
- RAUTHERM universal pipe 20 x 1.9mm up to 20mm.



Art. No. 138062 - Quick-action mechanism for up to 40mm pipe

Delivery Make-up	
Art. No.	138062
Quantity	1 piece
Width	0.35kg



Art. No. 137495 - Ratchet mechanism

Delivery Make-up	
Art. No.	137495
Quantity	1 piece
Weight	0.30kg

Pressure Pump

- Precision test pump for pressure testing
- Pressure testing possible with water and anti-freeze
- Filling and pressure testing in one operation.

The REHAU pressure pump can be used to pressure test all REHAU underfloor heating systems according to BS 1264 - 4. For details on pressure testing and protocols see page 72

- Commissioning.



Delivery Make-up	
Art. No.	257314
Quantity	1 piece
Weight	7.2kg

Technical Data	
Dimensions in mm	720x170x260
Container volume	12 litres
Pressure range	0 - 60 bar
Pump volume	Around 45 ml/stroke
Connection	R 1/2"

2. GENERAL SYSTEM COMPONENTS AND ACCESSORIES

PIPE UNWINDER



REHAU supply two types of pipe unwinder.

Pipe unwinder 300

REHAU pipes carrying a medium are quickly and easily installed at the constructed site with the REHAU pipe unwinder.

- RAUTHERM universal pipe 16 x 1.5mm recommended for lengths of up to 600m
- RAUTHERM universal pipe 20 x 1.9mm recommended for lengths of up to 600m.

Assembly

- Loosen transportation securing screw
- Fold out moving feet
- Pull out foot extensions
- Fold out support arms
- Fold securing arms up
- Pull out extensions up to the maximum ring height/width.

Delivery Make-up	
Art. No.	286151
Quantity	1 piece

Technical Data	
Diameter in total	1.4m
Height when fully assembled	Around 86cm
Material	Galvanised steel
Weight without pipe bundle	Around 12.5Kg

Hint: To avoid any unwanted movements after unwinding, you can tighten the safety screw if necessary.



Attention! Danger of injury by turning parts.



Pipe unwinder 600

For hot laying

- RAUTHERM universal pipe 16 x 1.5mm recommended for lengths of up to 490m
- RAUTHERM universal pipe 20 x 1.9mm recommended for lengths of up to 500m.

Requirements for use

- Rotating current of 110V/2A for temperature-control unit
- Water connection available
- Manifold installed in the intended position.

Description

The REHAU pipe unwinder (for hot laying) consists of the dispenser to which a temperature-control unit with a circulating pump can be connected. By circulating 50°C to 60°C water, the pipes to be installed become soft and pliable even under adverse conditions, making laying quick and easy.

Assembly

- Flow/return of the temperature-control unit connected to the flow/return of the REHAU manifold
- Place pipe roll on the pipe unwinder
- Connect flow pipe roll to the corresponding manifold outlet
- Connect return pipe roll to the drum lance of the pipe unwinder and install the hose connection back to the manifold from there
- Fill pipe roll and temperature-control unit with water and commission it.

Delivery Make-up	
Art. No.	260108
Quantity	1 piece
Weight	67kg

Technical Data	
Length	1.20m
Width	0.78m
Height	0.93m
Weight without pipe	Around 40kg

Pipe Retaining Rail and Fixing Lugs

The REHAU pipe retaining rail offers an easy and tidy way of fixing the pipes below the manifold. It comes in 1m lengths and can be trimmed to match any manifold width (2-port to 12-port).

The fixing lugs can be freely adjusted to suit any pipe size. We recommend to sleeve all pipes with REHAU corrugated sleeve before fixing them to the rail.

Delivery Make-up		
Item	Rail	Lugs
Art. No.	251506	251486
Length	1m	-
Weight	0.13kg/m	8 gr/piece



90° Pipe Bend Former

REHAU pipe bend formers can be used alternatively to the REHAU retaining rail to provide a stable and defined way of fixing the pipe below the manifold. They can also provide additional support in areas of tight bend radii, e.g. installations with 20mm pipe spaced at 100mm centres (sprung floor installations). In such cases the bend formers prevent the pipe from kinking every time the pipe is heated up.

Delivery Make-up		
Art. No.	258408	258798
Pipe size	16mm	20mm
Radius	80mm	100mm
Material	Electroplated steel	
Weight	0.045kg	0.080kg



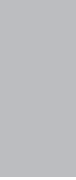

3. MANIFOLDS AND CABINETS

TABLE OF CONTENTS

REHAU Manifolds

Standard Manifold	pg20
Flow Meter Manifold	pg20
Fittings.	pg20
Positioning	pg20
Boiler Connection	pg20
Installation Instructions - Surface mounted manifold	pg21

REHAU Cabinets

Surface Mounted AP (above plaster)	pg22
Flush Mounted UP (under plaster)	pg22
Installation Instructions - Manifold within a surface mounted cabinet	pg23
Installation Instructions - Manifold within a flush mounted cabinet	pg25

3. REHAU MANIFOLDS

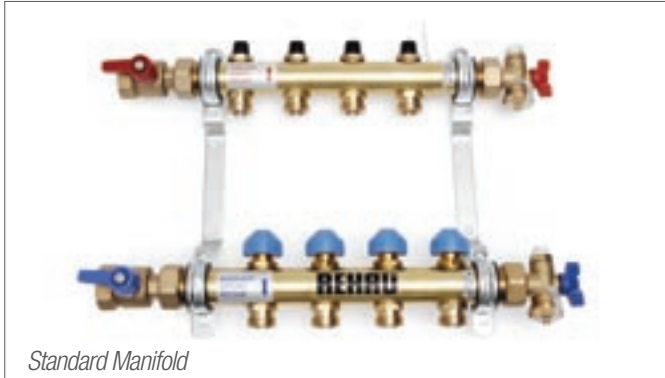

REHAU supply two types of manifolds:

- Standard manifolds
- Flow meter manifolds.

Both manifolds are available for 2 - 12 underfloor heating circuits and are supplied fully assembled with galvanised fixing brackets.

Each manifold with 1" flow / return headers are produced as a single unit from high quality brass (Ms63/CW508L).

The connections on the flow header (identified by the red label "supply") should be off set to the connections on the return header, this allows for easy installation.

Standard Manifold

- The flow valves for the thermal actuators are on the return header (identified by the blue label "return")
- The combination flow and balancing valves are located on the flow header (identified by the red label "supply")
- To adjust the balancing valve, please use the key provided
- The manifolds are fully compliant to BS 1264 - 4.

Flow Meter Manifold

- The flow meters are on the flow header (identified by the red label "supply")
- The thermal actuators fit onto the combination flow and balancing valves, which are located on the return header (identified by the blue label "return")
- To adjust the balancing valve, please use the key provided
- They feature quick stop isolating valves for each circuit as required by BS 1264 - 4.

For Industrial applications please contact your local REHAU sales office.

Fittings

All manifolds are supplied with:

- Two 1" isolation ball valves - red for boiler flow and blue for boiler return
 - Two combination valves with manual air vent and fill/drain point.
- Both can be mounted either side of the headers.

Fixings

The manifolds should be fixed directly to a solid structure, or within a manifold cabinet. When attaching the RAUTHERM pipe to the manifold a REHAU retaining pipe rail should be used along with fixing lugs to secure the pipe in place.

Positioning

To keep the connecting pipes to the manifold at a reasonable length, it is recommended that it be positioned in a central location to the area it is serving.

The correct position will be identified on the underfloor heating installation drawing and the design data sheets.



Make sure that the manifold can be accessed for adjustments and maintenance when the project is complete.

Boiler Connection

The flow and return from the boiler are connected to the manifold headers via the isolation valves using the flush faced pump unions and fibre washers provided.

If a REHAU compact mixer is to be introduced at a later stage (on commissioning), then the isolation valves will be replaced by a balancing valve and a thermostatic inlet valve.

3. REHAU MANIFOLDS

INSTALLATION INSTRUCTIONS - SURFACE MOUNTED MANIFOLD ON BRICKWORK OR TIMBER

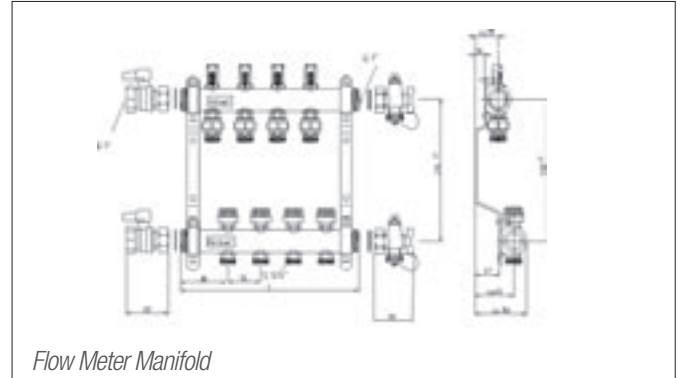
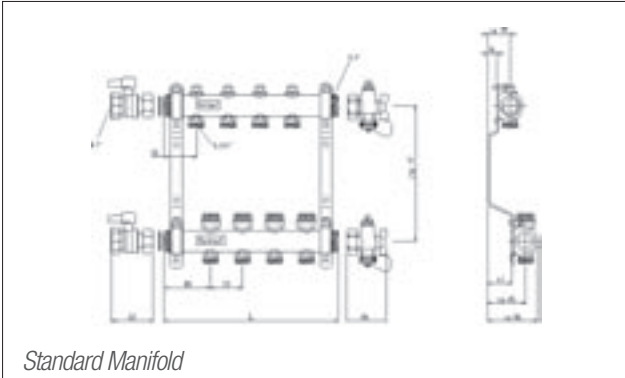

When fixing a REHAU manifold to timber studding or plaster board walls, it is recommended that fixing timber is placed within the timber wall construction where the manifold fixing points are to be drilled and screwed. This will ensure a secure fix for the manifold. Where this is not possible, suitable cavity fixings can be used.

Step 1 - Fix the manifold onto the wall using the fixing holes on the bracket and the plugs / screws provided. It must be 650mm from the top of the EPS floor insulation to the top header and level.

Step 2 - Connect the 1" quarter turn isolation valves to the top and bottom headers (same end) of the manifold. To avoid leaks ensure that the fibre washers provided are positioned between the valve face and the manifold prior to tightening the union nut.

Step 3 - Connect the combined drain valve and air vent to the top and bottom headers of the manifold on the opposite side to the isolation valves. Again, to avoid leaks ensure that the fibre washers are in position between the valve face and the manifold prior to tightening the union nuts.

Step 4 - The pipe retaining rail should be fixed approximately 175mm below the manifold and should be trimmed to suit the size of the manifold. It is recommended that +150mm is added to the length of the rail over the length of the manifold.

Step 5 - Place the fixing lugs onto the rail, push them tight against either side of the pipe (now protected by the corrugated sleeve) and screw them tight, once in position.

Technical Data

Dimensions											
Ports	2	3	4	5	6	7	8	9	10	11	12
L in mm (See drawings above)	190	245	300	355	410	465	520	575	630	685	740
Total	312	367	422	477	532	587	642	697	752	807	862

Manifold Selection Table		
RAUTHERM	16 x 1.5mm Art. No. 136430	20 x 1.9mm Art. No. 136450
Standard manifold	Y	Y
Flowmeter manifold	Y	Y

Components	
Material	Brass MS63 (CW508L)
Flow & return headers	One piece brass, 1"
Standard manifold	- 1 x combination flow and balancing valve per circuit in the flow - 1 x flow valve per circuit for actuator in the return
Flow meter manifold	- 1 x flow meter per circuit in the flow - 1 x quick stop isolation valve in flow - 1 x combination flow and balancing valve per circuit onto which the actuator is snapped with combined balancing function in return
Combined air vent and fill & drain point	- 1 x 3/8" air vent - 1 x 1/2" fill & drain point
Port spacing	55mm
Brackets	Noise dampened for wall and cabinet installation

3. REHAU CABINETS

REHAU offer two types of cabinets:

- Surface mounted cabinet AP (above plaster)
- Flush mounted cabinet UP (under plaster).

Both types of cabinet:

- Manufactured from galvanised steel
- Access panel with latch
- Height adjustable bracket for the manifold (flush mounted cabinet only)
- Available in different sizes.



Surface Mounted Cabinet AP (above plaster)

The surface mounted cabinet can not be adjusted in height or depth. The flow and return from the boiler and all the underfloor heating connections must enter from the bottom of the cabinet by removing the kickplate. If this is not feasible, holes larger than the pipe diameter can be drilled through the side panels of the cabinet.



Flush Mounted Cabinet UP (under plaster)

The flush mounted cabinet can be adjusted in both height and depth:

- Height 700 - 850mm
- Depth 110 - 160mm.

The flow and return from the boiler and all the underfloor heating connections can enter the cabinet from the bottom or from either side of the cabinet through the pipe knockouts.

The kickplate is also height adjustable, ensuring a tidy finish to the cabinet whatever the screed depth.

3. REHAU CABINETS

INSTALLATION INSTRUCTIONS - MANIFOLD WITHIN A SURFACE MOUNTED CABINET

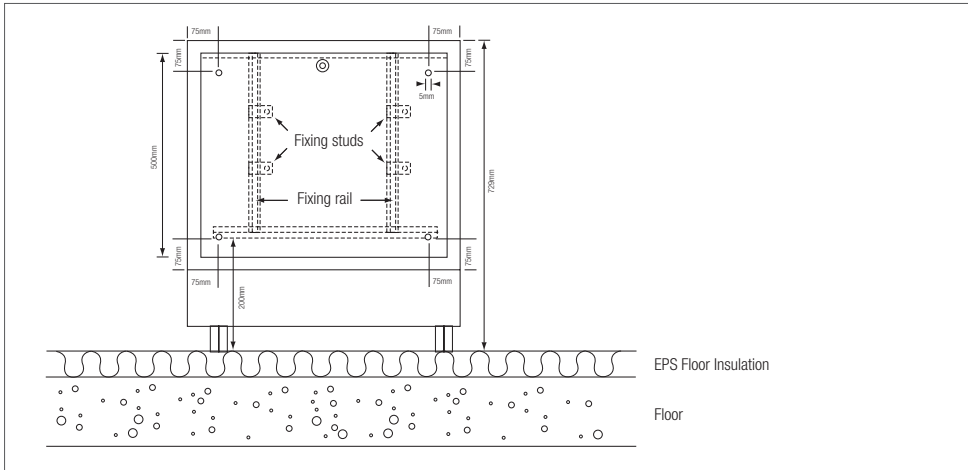

Step 1 - Remove the access panel by turning the white catch on the front of the cabinet to the vertical position.

Step 2 - The manifold cabinet should be placed against the plastered wall and directly onto the EPS floor insulation.

Step 3 - Drill four 5mm fixing holes into the back of the cabinet using a high speed metal drill bit. The top two holes should be drilled 75mm from top and side of the cabinet. The bottom two should be drilled 200mm from the top of the EPS floor insulation and 75mm from the side of the cabinet.

Step 4 - Mark the fixing holes onto the wall, drill four x 8mm holes, insert the plugs and fix the cabinet to the wall using four 2" x 10 screws. N.B. If the wall has not been plastered, the cabinet should be off-set to include the thickness of the plaster.

Step 5 - Adjust the fixing rail inside the cabinet until the fixing studs are in position to the fixing holes on the manifold bracket. Remove the wing nuts and fit the manifold. Replace the wing nuts but do not fully tighten.

Step 6 - Adjust the height of the manifold to 650mm (recommended) from the EPS floor insulation to the top of the manifold header. Ensure the manifold is level and tighten the wing nuts until it is secure.

Step 7 - Connect the 1" quarter turn isolation valves to the top and bottom header (same end) of the manifold. To avoid leaks ensure that the fibre washers provided are positioned between the valve face and the manifold prior to tightening the union nut.

Step 8 - Connect the combined drain valve and air vent to the top and bottom header of the manifold on the opposite side to the isolation valves. Again, to avoid leaks ensure that the fibre washers are in position between the valve face and the manifold prior to tightening the union nuts.



1. The pipework should always enter the cabinet from below. If the pipework has to enter the cabinet from drilled access holes, ensure that the holes have been filed down using emery paper to avoid sharp edges damaging the pipe.

2. Ensure that no pipework when fitted to the manifold is touching any part of the cabinet. This will eliminate any noise when the pipework expands and contracts.

Cabinet Selection Table

Number of Ports	Surface Mounted AP (above plaster) Cabinet Type		
	Manifold Only	Compact Mixer	Variable Flow System
2	2	2	4
3	2	4	4
4	2	4	4
5	2	4	4
6	4	4	7
7	4	7	7
8	4	7	7
9	7	7	9
10	7	7	9
11	7	9	9
12	7	9	9

Dimensions

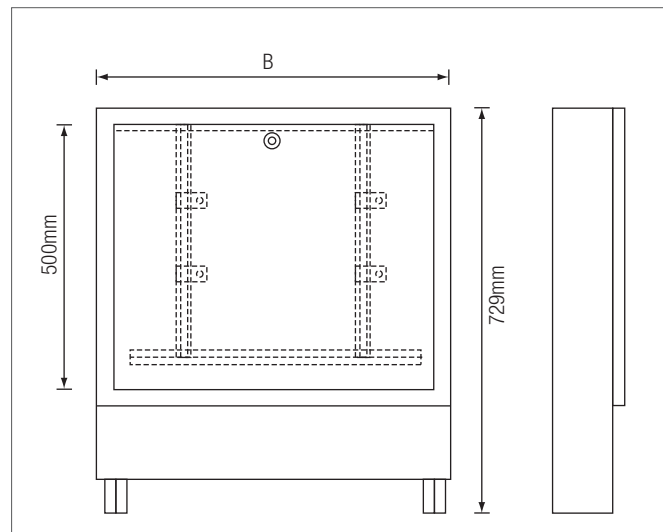

Technical Data

Cabinet Type	2	4	7	9
Height (mm)	729	729	729	729
Width (mm) (B)	605	805	1005	1205
Depth (mm)	150	150	150	150
Weight (kg)	11.6	14.2	17.6	20.7

3. REHAU CABINETS

INSTALLATION INSTRUCTIONS - MANIFOLD WITHIN A FLUSH MOUNTED CABINET

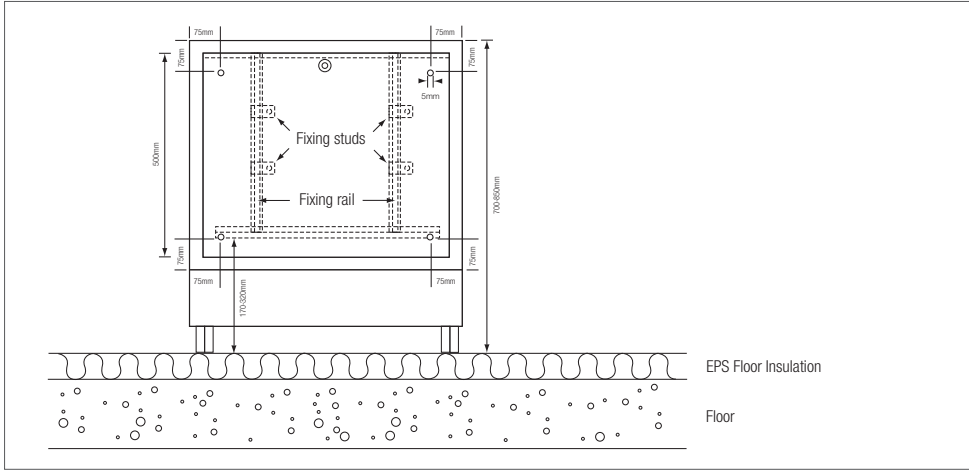

Applies to both fixings

Step 1 - Remove the access panel by turning the white catch on the front of the cabinet to the vertical position.

Fixing the cabinet to brickwork

Step 2 - The builder must provide a suitable sized hole and lintel within the brick/block work for the cabinet to be freely fitted.

Step 3 - Drill four 5mm fixing holes into the back of the cabinet using a high speed metal drill bit. The top two holes should be drilled 75mm from top and side of the cabinet. The bottom two should be drilled 75mm from the bottom of the cabinet and 75mm from the side of the cabinet.

Step 4 - Before marking and drilling the fixing holes into the wall check that the cabinet face is level and flush against the final wall finish level.

Step 5 - Remove the cabinet, holes where marked, plugs and secure into position using four 2" x 10 screws.

Fixing the cabinet to timber frame

Step 2 - The builder must provide timber fixing posts at either side of the cabinet position.

Step 3 - The cabinet should sit directly onto the EPS floor insulation and be fixed to each side of the timber fixing posts. Before fixing check that the cabinet face is level and flush against the final wall finish level. Secure the cabinet into position using four 1" x 10 screws.

Step 4 - Adjust the fixing rail inside the cabinet until the fixing studs are in position to the fixing holes on the manifold bracket. Remove the wing nuts and fit the manifold. Replace the wing nuts but do not fully tighten.

Step 5 - Adjust the height of the manifold to 650mm (recommended) from the EPS floor insulation to the top of the manifold header. Ensure the manifold is level and tighten the wing nuts until it is secure.

Cabinet Selection Table

Number of Ports	Flush Mounted (above plaster)		
	Manifold Only	Compact Mixer	Variable Flow System
2	1	2	3
3	1	3	3
4	2	3	4
5	2	4	4
6	3	4	5
7	3	5	6
8	4	6	7
9	5	7	8
10	5	7	8
11	7	8	9
12	7	9	9

Dimensions

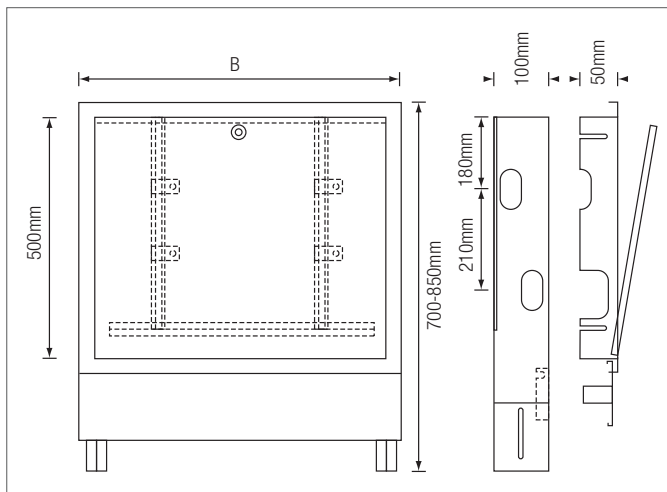

Technical Data

Cabinet Type	1	2	3	4	5	6	7	8	9
Height (mm) ¹⁾	700-850	700-850	700-850	700-850	700-850	700-850	700-850	700-850	700-850
Width (mm) (B)	450	554	665	754	835	868	954	1033	1154
Depth (mm) ²⁾	110-160	110-160	110-160	110-160	110-160	110-160	110-160	110-160	110-160
Cut out for pipes width (mm)	500	600	700	800	900	900	1000	1100	1200
Cut out for pipes height (mm)	850	850	850	850	850	850	850	850	850
Cut out for pipes depth (mm)	125-175	125-175	125-175	125-175	125-175	125-175	125-175	125-175	125-175
Weight (kg)	10.9	12.4	14.1	15.7	17.1	17.7	18.9	20.3	21.7

¹⁾ Height adjustable from 700-850mm through adjustable feet.

²⁾ Adjustable front cover allows installation of cabinet into wall openings with a depth of between 110 and 160mm.

Step 6 - Connect the 1" quarter turn isolation valves to the top and bottom header (same end) of the manifold. To avoid leaks ensure that the fibre washers provided are positioned between the valve face and the manifold prior to tightening the union nut.

Step 7 - Connect the combined drain valve and air vent to the top and bottom header of the manifold on the opposite side to the isolation valves. Again, to avoid leaks ensure that the fibre washers are in position between the valve face and the manifold prior to tightening the union nuts.



1. The pipework should always enter the cabinet from below or from the sides. If the pipework has to enter the cabinet from drilled access holes, ensure that the holes have been filed down using emery paper to avoid sharp edges damaging the pipe.

2. Ensure that no pipework when fitted to the manifold is touching any part of the cabinet. This will eliminate any noise when the pipework expands and contracts.

4. CIRCUIT LAYING PATTERNS

TABLE OF CONTENTS

Laying Patterns pg28

Perimeter Zones pg29

4. LAYING PATTERNS



The heating requirement for a room is met using any of the following laying patterns. The temperature distribution within the room alone will be effected dependent on which pattern is used.

Reverse Spiral

- REHAU Tacker Sheet System **Y**
- REHAU RAUFIX/Railfix System **N**
- REHAU Diffusion Plate System **N**
- REHAU Floating Floor System **N**
- REHAU Sprung Floor System **N**

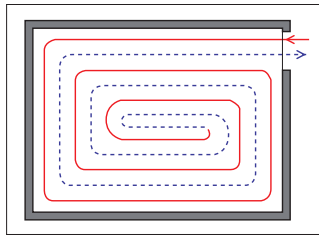

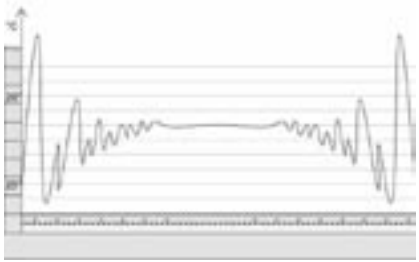
Application	All installations except suspended floor
Pipe	- Only 90° pipe bends - Less demand on pipe
Room Geometry	Suitable for any area
Temperature Distribution	

Double Meander

- REHAU Tacker Sheet System **Y**
- REHAU RAUFIX/Railfix System **Y**
- REHAU Diffusion Plate System **N**
- REHAU Floating Floor System **N**
- REHAU Sprung Floor System **Y**

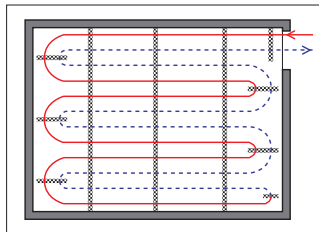

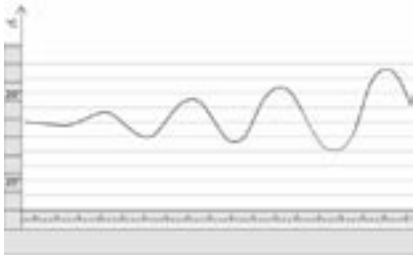
Application	Large industrial installations
Pipe	- 180° pipe returns demanding on pipe - Minimum bend radii to observe
Room Geometry	Suitable for large / industrial areas
Temperature Distribution	

Single Meander

- REHAU Tacker Sheet System **N**
- REHAU RAUFIX/Railfix System **N**
- REHAU Diffusion Plate System **Y**
- REHAU Floating Floor System **Y**
- REHAU Sprung Floor System **N**

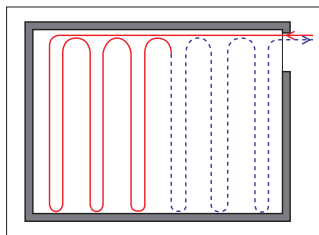

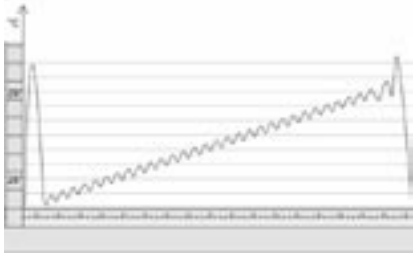
Application	Suspended floors
Pipe	- 180° pipe returns demanding on pipe - Minimum bend radii to observe
Room Geometry	Suitable for any area
Temperature Distribution	

4. PERIMETER ZONES

The heat requirement of a room reduces from the wall to the centre of the room. Therefore pipes are laid closer together in areas where heat requirements are greater and are known as perimeter zones.

Perimeter zones are dependent upon:

- The type of external wall - K value
- Number, size and quality of windows
- How the room is to be used.

By using the reverse spiral or double meander laying pattern with a smaller pipe spacing in the perimeter zone than in the occupied zone the following can be achieved:

- A higher level of heating comfort throughout the room
- Pleasant floor temperatures despite the higher heat output
- A reduction in required flow temperatures, reducing energy consumption.

Double meander laying pattern with perimeter zones

Perimeter Zone:
- as part of main circuit
- closer pipe spacing

Occupied Zone with
different pipe spacing

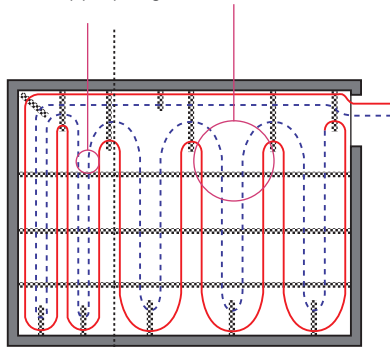

Compressed Perimeter Zone with double meander pattern

Perimeter Zone:
- separate connecting lengths
- closer pipe spacing

Occupied Zone with
separate connecting lengths

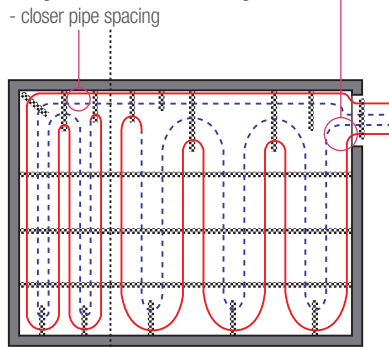

Separate Perimeter Zone with double meander pattern

Perimeter Zone:
- as part of main circuit
- closer pipe spacing

Occupied Zone with
- different pipe spacing
- supplied after the perimeter zone

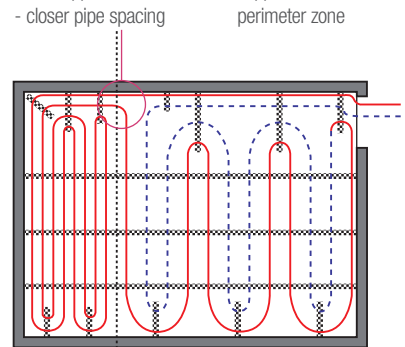

Upstream Perimeter Zone with double meander pattern

Reverse spiral laying pattern with perimeter zones

Perimeter Zone:
- as part of main circuit
- closer pipe spacing

Occupied Zone with
different pipe spacing

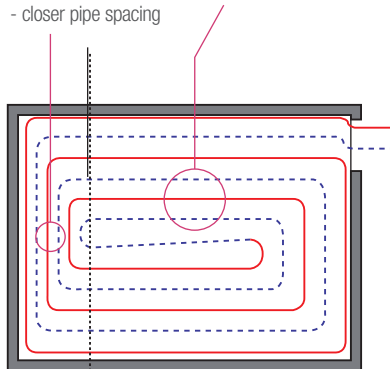

Compressed Perimeter Zone with reverse spiral pattern

Perimeter Zone:
- separate connecting lengths
- closer pipe spacing

Occupied Zone with
separate connecting lengths

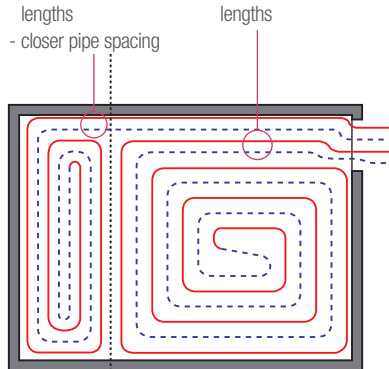

Separate Perimeter Zone with reverse spiral pattern

Perimeter Zone:
- as part of main circuit
- closer pipe spacing

Occupied Zone with
- different pipe spacing
- supplied after the perimeter zone

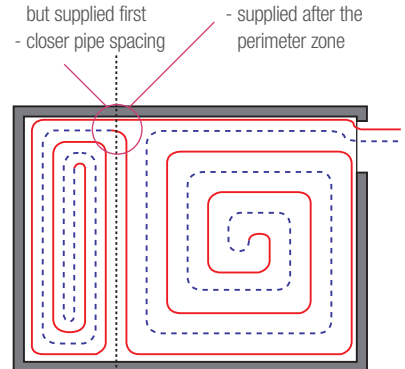

Upstream Perimeter Zone with reverse spiral pattern

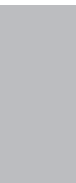

5. FLOOR INSTALLATION SYSTEMS

TABLE OF CONTENTS

Tacker Sheet System.	pg32
RAUFIX/Railfix System	pg37
Diffusion Plate System	pg42
Floating Floor System	pg47
Sprung Floor System.	pg52

REHAU also supplies the following system:

- Industrial/Structural Systems.

For further information please contact your local REHAU Sales Office.

5. TACKER SHEET SYSTEM



This system saves significant time and costs during the installation process by combining previously separate installation steps into one.

When compared to a standard fixing rail system, the steps of:

- Rolling out a polyethylene foil on top of the EPS boards
- Fixing the rails to the EPS boards are no longer required.

In addition to this, the Tacker Sheet system also allows more flexibility in circuit patterns.

Patterns, such as the reverse spiral are easier and quicker to install. The system has clear advantages, when circuits are installed in areas with drains, pillars, alcoves etc, since the pipe can now be easily laid around such obstacles.

The REHAU range of RAUTHERM pipe in sizes 16mm x 1.5mm and 20mm x 1.9mm are fully compatible with the Tacker Sheet system.

5. FLOOR INSTALLATION SYSTEMS

COMPONENT DESCRIPTION

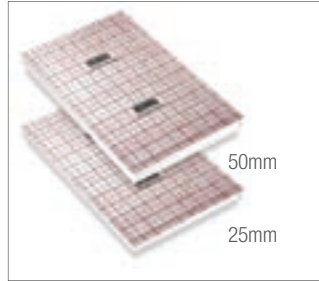
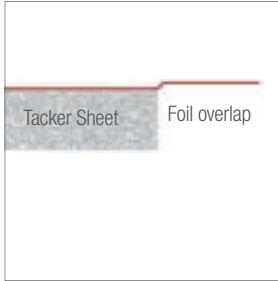

Tacker Sheets

The Tacker Sheet is made out of standard expanded polystyrene grades already well established within the building industry. They comply with the relevant industry standard and are CFC free.

Each board is laminated with a fabric reinforced foil made from polyethylene. A grid system is printed onto the clear foil allowing the installer to quickly determine the appropriate pipe spacing during the installation. The fact, that the foil is water resistant, together with the foil overlaps on two adjacent sides of each board ensure, that when the joints are sealed with tape, no water from the screed will penetrate through to the insulation.

Tacker Sheet is available in EPS70, EPS100 and EPS 150 grades in both 25mm and 50mm thickness. Standard Fire Class is F (according to BS EN 13163).

Tacker Staples

REHAU Tacker Staples are available in two specifications – grey staples for 16mm pipes and black staples for 20mm pipes. The two size specifications and innovative hook design ensure secure fixing of the pipes onto the Tacker Sheet. The latter ensures maximum retention of the staples by the foil's fabric reinforcement, thereby preventing the pipe from lifting during the screeding process.

When fixing the pipe, staples should be positioned at maximum intervals of 400mm centres of pipe length. If Tacker Staples are set wrongly and are consequently pulled out, it is crucial to tape over the grid holes punched by the staples.

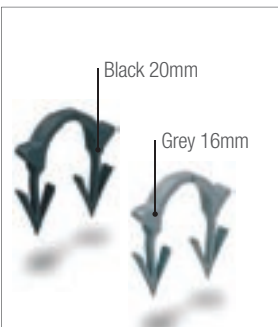

The staples are heated and attached to form magazines of 30 staples each. The usual securing strap and any impairment of the setting procedure via gluing with remains of the securing strap does not apply.

REHAU Tacker Staples should only be fixed into the Tacker Sheet with the REHAU Tacker staple gun.

REHAU Multi Stapling Unit

The REHAU multi stapling unit is used for setting RAUTAC staples/ REHAU staples on the REHAU stapling panels. A clip fixing tool is still required for further processing of both staples.

The staples magazines are inserted into the magazine rod shaft.

A feeding aid increases the pressure on the staples and ensures proper setting of the staples and thus short installation times.



Even downward pressure on the ergonomically-shaped actuator handle inserts the staples into the cloth film of the REHAU stapling panels. When the actuator handle is released, it returns to its original position via a spring, and the setting procedure can be repeated straight away.

Upgrade set for RAUTAC stapling unit and REHAU stapling unit

To use the heat-formed staples magazine with the RAUTAC stapling unit, the clip fixing tool must be equipped with an upgrade set. You can obtain this at your respective REHAU sales office.

In just a few steps, the upgrade set is mounted to the stapling unit. Installation instructions are included with each upgrade set for this purpose.

A feeding aid which applies pressure to the staples magazine is included with the upgrade set.

- Attach the feeding aid to the full magazine rod to ensure even feeding of the staples and optimum loading pressure.

The staples are heated and attached to form magazines of 30 staples each. The usual securing strap and any impairment of the setting procedure via gluing with remains of the securing strap does not apply.

5. TACKER SHEET SYSTEM INSTALLATION INSTRUCTIONS

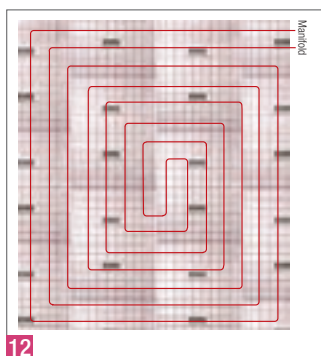
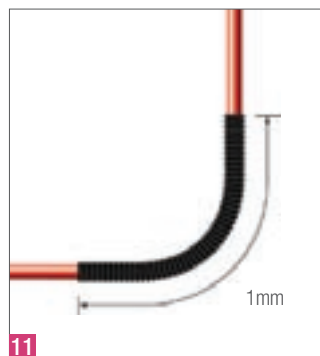
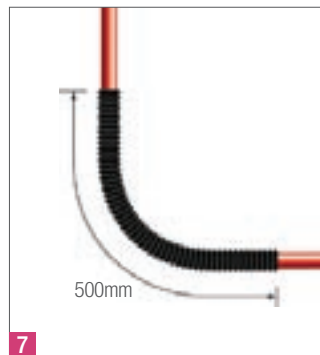
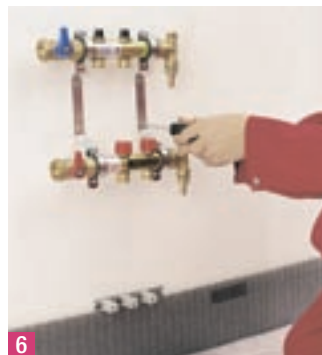

Step 1 - Make sure site requirements for installing underfloor heating are met: rooms cleared, installation area dry, sealed to the elements, flat even floor and surface free of irregularities.

Step 2 - Fit REHAU Edge insulation around perimeter and internal walls, columns, drains and door frames ensuring a 50mm overlap at joints (insulation already comes with self adhesive tape on back).

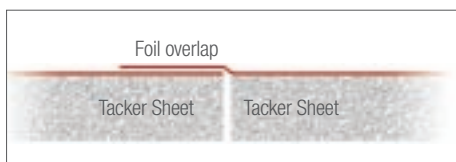

Step 3 - Lay Tacker Sheet boards ensuring the following:

- Printed foil faces
- Grid lines up across the joints
- Stagger the joints as in a brick wall
- Each joint is covered with a foil overlap (Tacker Sheet already comes with a foil overlap on two adjoining sides)
- Tacker Sheets are butted tightly up against each other.

Step 4 - Tape all joints to ensure no water from the screed passes underneath the boards.

Step 5 - Remove cover from adhesive tape from the foil on edge insulation and fix it to Tacker Sheets.

Step 6 - Fix manifold and retaining rail to wall or into cabinet.

Step 7 - Cut a short piece of corrugated sleeve (at least 0.5m long) and slide it over the pipe end. Sleeve is to protect pipe from shearing where it enters the screed.

Step 8 - Connect REHAU RAUTHERM pipe to manifold using REHAU pipe connection unions.

Step 9 - Start laying the circuit by simply stapling the RAUTHERM pipe onto the Tacker Sheet using the correct sized REHAU Tacker staples and staple gun (see table overleaf for details). Set staples at a maximum interval of 400mm.

To push a staple into the insulation, simply push down the handle of the gun fully and allow it to travel back up again completely, before pushing in the next staple.

- Always ensure there is a sufficient number of staples on the carrier to allow correct feeding of the staples into the staple gun
- If staples are pulled out of the Tacker Sheet, tape over the punched holes to keep top surface water resistant.

Step 10 - When installing pipe in door frames, holes through walls or across planned expansion joints, always put on a section of corrugated sleeving in this area to allow free movement of pipe. Sleeving can be split along the length and clipped over the pipe.

Step 11 - Before connecting return to manifold, slide on another 0.5m long corrugated sleeve section.

Step 12 - Install remaining circuits in the same way as detailed in steps 7. to 11.

- For commissioning see page 72.

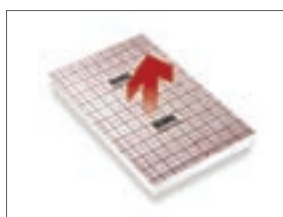

IMPORTANT
Printed foil facing upwards



IMPORTANT
Use correct size of staples

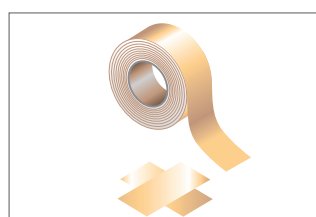

IMPORTANT
Tape all joints

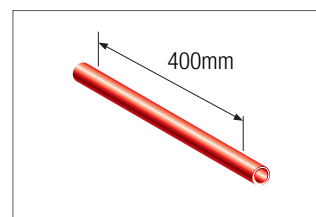

IMPORTANT
Use staples at least every 400mm

Component Selection Table

Components	16mm RAUTHERM Pipe Art. No. 136430	20mm RAUTHERM Pipe Art. No. 136450	Average Quantity
Tacker Staples Art. No. 240221, grey colour Art. No. 262373, black colour	Y N	N Y	2.5 per metre pipe 2.5 per metre pipe
Tacker Gun Multi Art. No. 227835	Y	Y	
Tacker Sheets Complete range	Y	Y	0.35 sheets per m ²
Edge Insulation Art. No. 264411	Y	Y	Length of perimeter
Corrugated Sleeve Art. No. 137140 Art. No. 137150	Y N	N Y	1m per manifold port 1m per manifold port
REHAU Tape Art. No. 265942	Y	Y	1.25m per m ²
REHAU Tape Dispenser Art. No. 261959	Y	Y	
REHAU EPS Cutter Art. No. 249632 Art. No. 24652, spare cutter blades	Y Y	Y Y	

Technical Data

	EPS 70 25mm	EPS 70 50mm	EPS 100 25mm	EPS 100 50mm	EPS 150 25mm	EPS 150 50mm
REHAU Art. No.	238243	238233	233504	233494	286859	286864
Dimensions in mm (Length x Width x Thickness)	2400x1200x25	2400x1200x50	2400x1200x25	2400x1200x50	2400x1200x25	2400x1200x50
Make-up	Single Board	Foldable Board	Single Board	Foldable Board	Single Board	Foldable Board
Thermal conductivity	0.038 W/mK	0.038 W/mK	0.036 W/mK	0.036 W/mK	0.035 W/mK	0.035 W/mK
Compression strength 10%	>70 kPa	>70 kPa	>100 kPa	>100 kPa	>150 kPa	>150 kPa
Breaking strength	>115 kPa	>115 kPa	>150 kPa	>150 kPa	>200 kPa	>200 kPa
Designation to EN 13163 E	EN 13163-T1-L1 W1-S2-P3-DS(80,-)1	EN 13163-T1-L1 W1-S2-P3-DS(80,-)1	EN 13163-T1-L1 W1-S2-P3-DS(80,-)1	EN 13163-T1-L1 W1-S2-P3-DS(80,-)1	EN 13163-T1-L1 W1-S2-P3-DS(80,-)1	EN 13163-T1-L1 W1-S2-P3-DS(80,-)1
Fire class to EN 13163 E	F	F	F	F	F	F

Typical Floor Structure

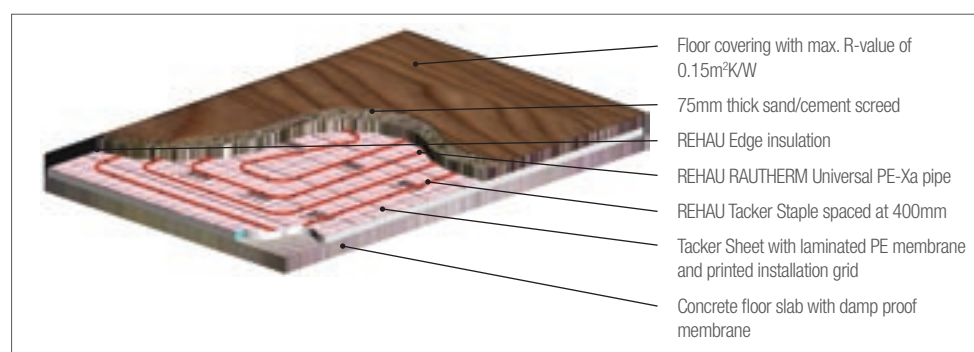

5. RAUFIX/RAILFIX SYSTEM



This system ensures that uniform circuit patterns are easily achieved and simplifies the installation process in larger areas.

The underfloor heating circuits can be laid in the double meander pattern, which gives an even spread of heat by alternating the flow and return pipes.

The REHAU range of RAUTHERM pipe in sizes 16mm x 1.5mm and 20mm x 1.9mm are fully compatible with the RAUFIX/Railfix system.

REHAU also offer the Railfix System. This system is an alternative to RAUFIX. The installation method follows that of RAUFIX, with the exception of using Railfix rails rather than RAUFIX. Railfix is supplied in 3m and 4m lengths for 16mm or 20mm pipe sizes.

5. RAUFIX/RAILFIX SYSTEM

COMPONENT DESCRIPTION

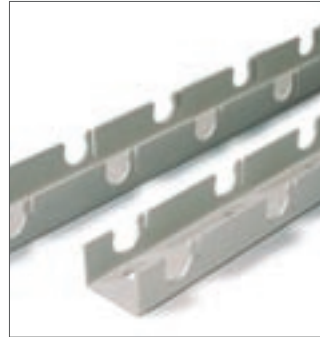

RAUFIX Rail

The RAUFIX rail is manufactured from Polypropylene and its unique pipe clip design makes it universal for both REHAU pipe sizes - 16mm and 20mm.

The function of the rail is to secure the underfloor heating circuits in the planned pattern prior to screeding.

The RAUFIX rails are supplied in 1m lengths and there are two variants:

- With barb:
Allows the rail to be fixed directly on the EPS floor insulation
- Without barb:
When fixing, extra staples are needed.

It is placed on top of the polyethylene membrane and fixed securely onto the EPS floor insulation by using the plastic staples or barbs.

The rails must be placed 800mm from walls and obstacles and spaced at 1m centres.

The RAUFIX rail also features an integrated clip which makes connecting rails together simple and easy without the need of a tool.

Railfix Rail

The Railfix rails are manufactured from recycled polymer and are available for both REHAU RAUTHERM pipe sizes - 16mm and 20mm.

The Railfix rail is notched at 50mm intervals to accept the pipe and is placed 800mm from walls and obstacles, spaced at 1m centres and must be fixed with staples every 400mm.

The rails are manufactured with a break point at 100mm centres to facilitate easy installation.

Staples

The REHAU RAUFIX/Railfix staples are available in two sizes - 50mm and 40mm. The size of staple used will depend on the thickness of the EPS floor insulation. For 25mm EPS floor insulation the 40mm staples should be used and pushed in through the rail at alternating angles. For 50mm EPS insulation it is recommended to use the 50mm staples.

Trim offs from the rails can also be used to fix the pipe bends to the EPS floor insulation.

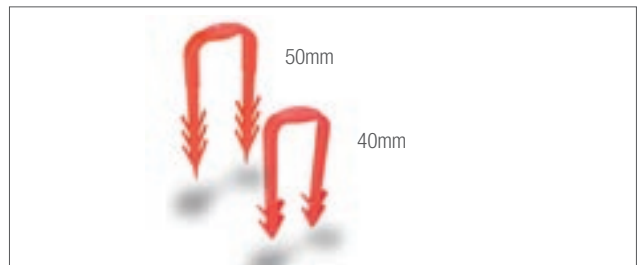

5. RAUFIX/RAILFIX SYSTEM

INSTALLATION INSTRUCTIONS

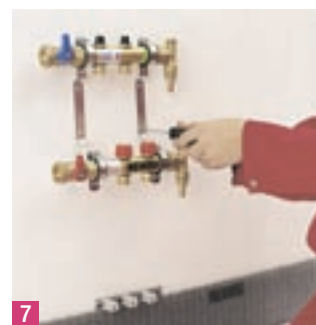
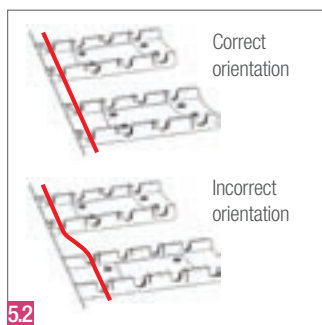
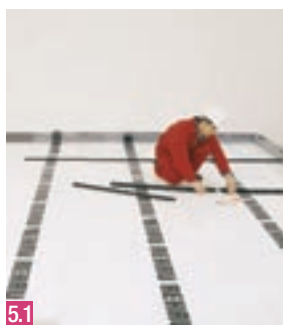
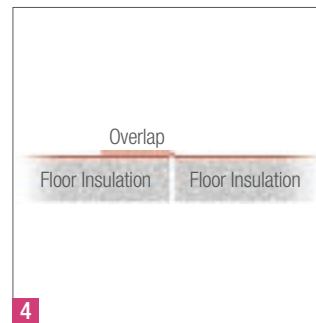

Step 1 - Make sure site requirements for installing underfloor heating are met: rooms cleared, installation area dry, sealed to the elements, flat even floor, and surface free of irregularities.

Step 2 - Fit REHAU Edge insulation around the perimeter and internal walls, columns, drains and door frames ensuring a 50mm overlap at joints (insulation already comes with self adhesive tape on the back).

Step 3 - Lay insulation ensuring the following:

- Stagger the joints as in a brick wall.
- Insulation boards are butted tightly up against each other.

Step 4 - Lay polyethylene membrane over floor insulation, ensuring that:

- It is placed up the walls, above the finished floor height
- The membranes overlap each other by 80mm
- The membrane must be watertight when used with an Anhydride (flow) screed, by taping the joints and the edge insulation.

Step 5.1 - RAUFIX - Fix rails to the EPS floor insulation using staples every 400mm. Rails must be fixed 800mm from walls and obstructions to allow for the bending radius of the pipe. The remainder of the area should have rails laid at 1m centres.

Step 5.2 - Railfix - Fix rails to the EPS floor insulation using staples every 400mm. Keep orientation of rail the same to ensure correct pipe spacing.

Step 6 - In areas of pipe bends/returns, rail trim offs can also be used to fix the pipe bends directly to the floor insulation and to ensure uniform spacing.

Step 7 - Fix manifold to wall or into cabinet and fix retaining rail.

5. RAUFIX/RAILFIX SYSTEM INSTALLATION INSTRUCTIONS

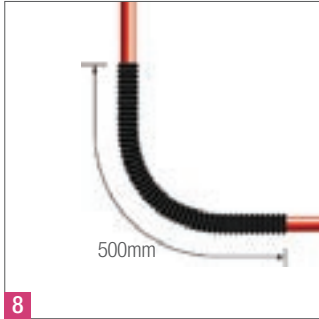

8



9



10



11



12

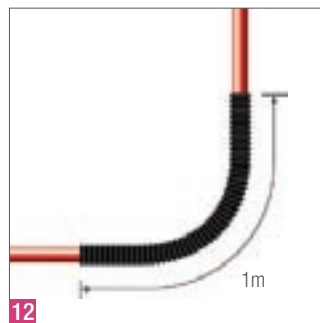

12

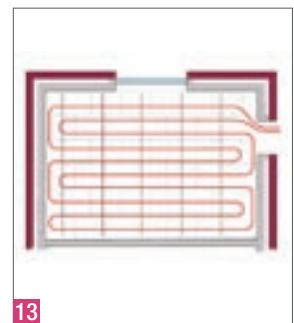

13

Step 8 - Cut a short piece of corrugated sleeve (at least 0.5m long) and slide it over the pipe end. Sleeve is to protect pipe from shearing where it enters the screed.

Step 9 - Connect REHAU RAUTHERM pipe to the manifold using REHAU pipe connecting unions.

Step 10 - Start laying the circuit by simply "snapping" the pipe into the RAUFIX/Railfix rails. The circuit is laid in the double meander pattern as per the underfloor heating design.

Step 11 - When installing pipe in door frames, holes through walls or across planned expansion joints, always put on a section of corrugated sleeving in this area to allow free movement of pipe. Sleeving can be split along the length and clipped over the pipe.

Step 12 - Before connecting return to manifold, slide on another 0.5m long corrugated sleeve section.

Step 13 - Install remaining circuits in the same way, as detailed in steps 8 to 12.



IMPORTANT
Rails to be spaced evenly at 1m and 0.8m from walls

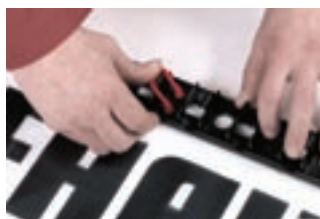

IMPORTANT
40mm Staples set at an angle for 25mm insulation

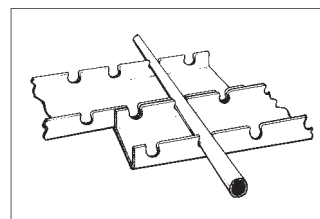

IMPORTANT
Railfix: End must overlap when extending rails

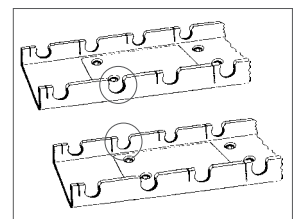

IMPORTANT
Railfix: Keep orientation of rail the same to ensure correct pipe spacing

Component Selection Table

Components	16mm Pipe Art. No. 136430	20mm Pipe Art. No. 136450	Average Quantity
RAUFIX Staples Art. No. 268118, 40mm Art. No. 259268, 50mm	Y Y	Y Y	3 pieces per m ² 3 pieces per m ²
RAUFIX Rail Art. No. 244248 with barbs Art. No. 240241	Y Y	Y Y	1 m per m ² 1 m per m ²
Edge Insulation Art. No. 264411	Y	Y	length of all perimeter walls
Corrugated Sleeve Art. No. 137140 Art. No. 137150	Y N	N Y	1 m per manifold port 1 m per manifold port
REHAU Adhesive Tape Art. No. 265942	Y	Y	1 m per m ²
REHAU Tape Dispenser Art. No. 261959	Y	Y	-
Polyethylene Membrane Art. No. 256054	Y	Y	1.3m per m ² floor

Technical Data

Polystyrene Insulation	40mm Staple Art. No. 268118	50mm Staple Art. No. 259268
EPS 70 25mm Art. No. 264195	Y	N
EPS 70 50mm Art. No. 264205	N	Y
EPS 100 25mm Art. No. 264175	Y	N
EPS 100 50mm Art. No. 264185	N	Y

Typical Floor Structure

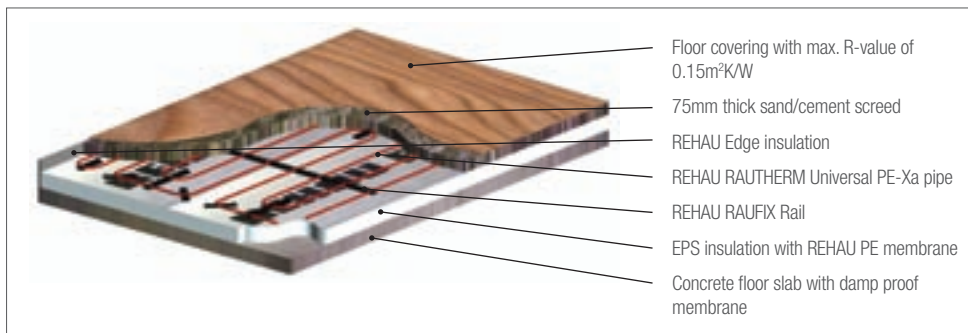

5. DIFFUSION PLATE SYSTEM



The REHAU Diffusion Plate system has been designed for timber joist floor applications.

The system uses aluminium plates to diffuse the heat over the floor area. Due to the high conductivity of the plates the reaction time compared to traditional screed systems is reduced.

It is installed into the building prior to wiring and plumbing.

Care must be taken when installing this system in open joists, please refer to the relevant Health and Safety guidelines.

The Diffusion Plate system utilises the REHAU RAUTHERM universal pipe 16mm x 1.5mm.

Because the heat transfer of this system is different to a standard screed system, standard design software such as HT2000 cannot be used.

5. DIFFUSION PLATE SYSTEM

COMPONENT DESCRIPTION

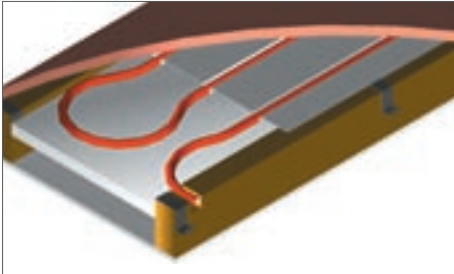

Diffusion Plates

The REHAU aluminium heat diffusion plates are designed for the use of underfloor heating in a first floor joist floor application. They are manufactured from 0.8mm thick aluminium and are supplied in 1m lengths (½ metre lengths available on request) either as:

- Two channel
- Three channel (to be used in bathrooms/en-suites where floor area is limited).

Both plates can be easily trimmed to length by cutting a 'V'-shaped notch into every channel using a hacksaw. Ensure any rough edges are removed by using a rat tailed file before fitting any pipes.

The pipes are tightly gripped within the plates ensuring maximum heat transfer. Due to its highly conductive nature, the aluminium plates diffuse the heat evenly over the plate area. The heat is then transferred through the floor surface into the room. Standard 25mm EPS 70 floor insulation (or alternative i.e. fibre glass wool) must be installed directly below the plates to reduce heat loss.

Joist Saddle Bracket

The joist saddle bracket is designed to support the EPS insulation to the correct depth below the plates. They are fitted over the joist at 500mm centres and at each insulation joint.

Please avoid air infiltration at the end of joist runs, as this will seriously affect the heat transfer.



When using the Diffusion Plate system on joists spaced greater than 400mm centres, joists must be overbattened at 90° to the joist run and spaced at 400mm centres. Battens should be 25mm x 50mm and fixed flat onto the joists. With this method, compressible insulation may be looped over the joists, to replace the 25mm EPS 70 and joist saddle brackets. If diffusion plates are to be used on ground floor joist insulation levels should be increased to meet current building regulations.

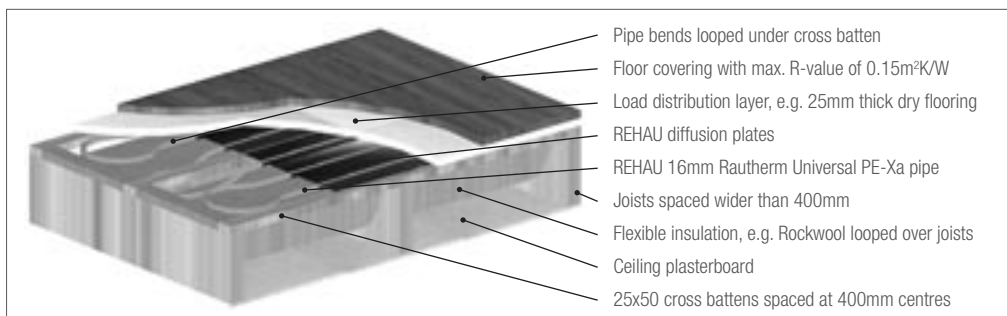

5. DIFFUSION PLATE SYSTEM INSTALLATION INSTRUCTIONS



1



2



3



4

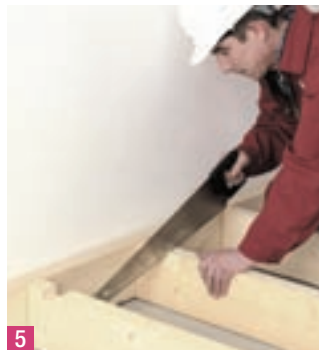

5



6

Step 1 - Make sure site requirements for installing underfloor heating are met: rooms cleared, installation area dry, sealed to the elements.

Step 2 - Fit the joist saddle brackets over the joists at 500mm spacings.

Step 3 - Cut the 25mm EPS 70 insulation and fit it tightly between the joists, covering the whole floor area.



To minimise air infiltration use compressible insulation material to block up any gaps at the end of each joist run.

Step 4 - Identify the quantity of plates for the area from the underfloor heating design. Distribute the plates evenly over the area ensuring that:

- A minimum gap of 100mm between the plates (lengthways)

- Plates are kept at least 500mm from the end of the joist to allow for pipe bends

- Plates are fitted with a slight upward camber, to ensure good contact with the flooring

- Each plate is fixed with 6 staples.

Step 5 - Notching of joists should be carried out according to the current building regulations:

($>0.07 \times \text{span from support}$, $<0.25 \times \text{span from support}$, not deeper than $0.125 \times \text{depth of joist}$).

When passing a pipe through a joist notch, it is recommended that precautions should be taken to allow for expansion, contraction and free movement of the pipe (see below).

Step 6 - Fix manifold to wall or into cabinet and fix retaining rail.

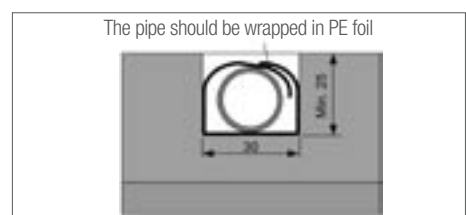

IMPORTANT
Notches are deep enough and lined

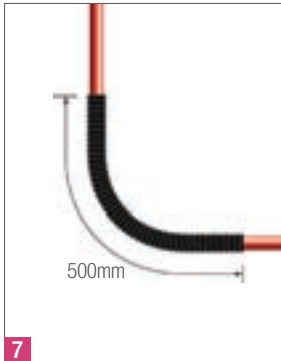

7



8



9



10

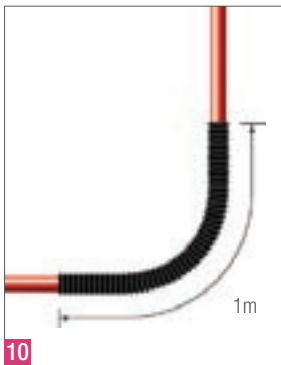

10

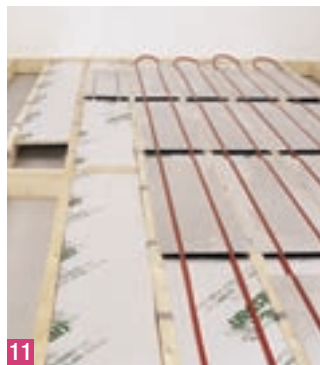

11



12

Step 7 - Cut a short piece of corrugated sleeve (at least 0.5m long) and slide it over the pipe end. Sleeve is to protect pipe from shearing where it enters the floor structure.

Step 8 - Connect REHAU RAUTHERM pipe to the manifold using REHAU pipe connecting unions.

Step 9 - Start laying the circuit by simply “snapping” the pipe into the plates. The circuit is laid in the single meander pattern as per the underfloor heating design.

When installing pipe in door frames or holes through walls, always put on a section of corrugated sleeving in this area to allow free movement of pipe. Sleeving can be split along the length and clipped over the pipe.

Step 10 - Before connecting return to manifold, slide on another 0.5m long corrugated sleeve section.

Step 11 - Install the remaining circuits in the same manner, as detailed in steps 7 to 10.

Step 12 - Lay the final floor covering at 90° to the plates.



For Health and Safety issues, under no circumstances should any other trades enter the room, before the final floor decking is placed.

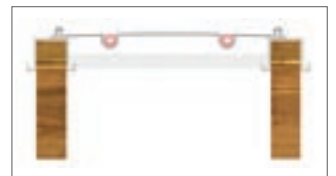

IMPORTANT
Plates to be fitted with a slight upward camber



IMPORTANT
For joists spaced wider than 400mm

Component Selection Table

Components	16mm RAUTHERM Art. No. 136430	20mm RAUTHERM Art. No. 136450	Average Quantity per m ²
2 Channel Plate Art. No. 249075	Y	N	1.6
3 Channel Plate Art. No. 249095	Y	N	1.6
2 Channel 1/2 Plate Art. No. 249085	Y	N	3.15
Joist Saddle Bracket Art. No. 249065	Y	N	9
EPS 70 Insulation Art. No. 264195	Y	N	0.35

Technical Data

	2 Channel Plate Art. No. 249075	3 Channel Plate Art. No. 249095	2 Channel 1/2 Plate Art. No. 249085
Size	1000mm x 380mm	1000mm x 380mm	500mm x 380mm
Thickness	0.8mm	0.8mm	0.8mm
Material	Aluminium	Aluminium	Aluminium
Conductivity	160 W/mK	160 W/mK	160 W/mK
Pipe Spacing	200mm	120mm	200mm

Typical Floor Structure

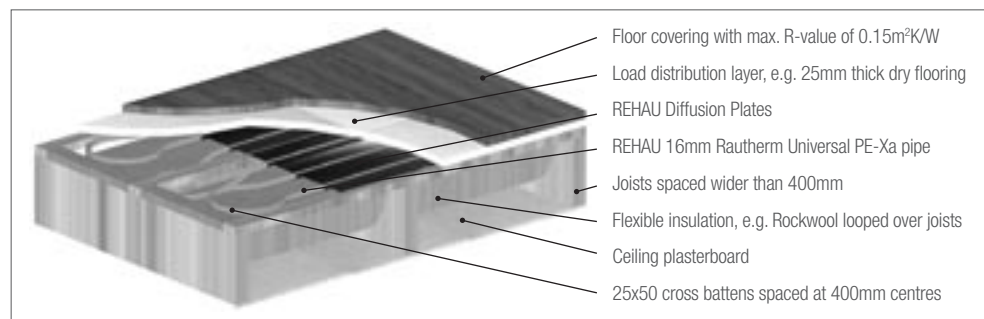
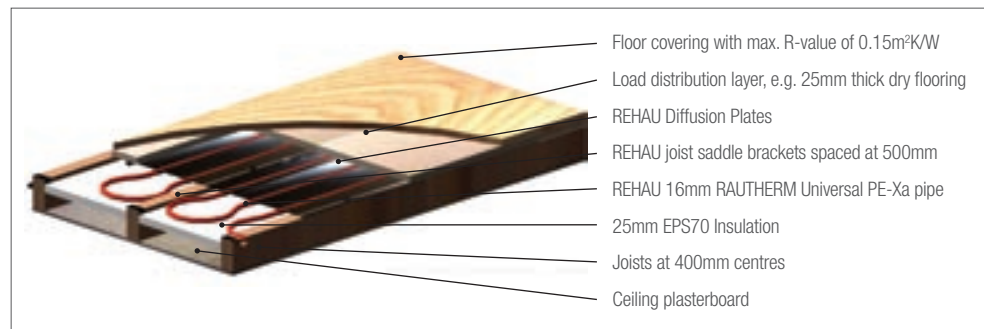

5. FLOATING FLOOR SYSTEM



This dry system is ideal for installations where a finished floor is required within a minimum time frame. No wet trades are involved, making it a very fast system to install and removes the need for other building trades.

The REHAU Floating Floor system is suitable for domestic as well as commercial applications. For domestic applications this can be chipboard or plywood, for commercial installations we recommend 25mm thick dry flooring elements.

Extruded polystyrene panels are pre-routed in different patterns and are laminated with a strong aluminium foil. The foil diffuses the heat uniformly across the entire floor surface, the response time is significantly reduced compared to traditional wet screed systems due to the lower thermal mass.

Floating Floor installations using the single meander pattern are possible on both solid and suspended substrates.

The REHAU Floating Floor system utilises the REHAU RAUTHERM Universal pipe 20mm x 1.9mm.

Because the heat transfer of this system is different to a standard screed system, standard design software such as HT2000 cannot be used.

5. FLOATING FLOOR SYSTEM

COMPONENT DESCRIPTION

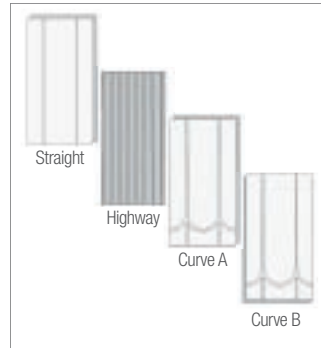
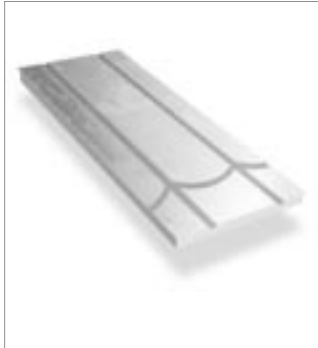

All floating floor panels are made from extruded Polystyrene XPS. Each panel features a rebate to create an interlocking floor. They are supplied in a standard size of 1.25m (L) x 0.6m (W) x 30mm (H) and are available in four variants:-

- Straight Panel (foil faced)
- Highway Panel (no foil)
- Curve A Panel (foil faced)
- Curve B Panel (foil faced).

Highway panels are used for all connecting lengths of pipe and to connect the pipework to the manifold.

Floor Preparation

The ground must be sufficiently level before the system is installed. To overcome unlevel ground a dry levelling compound can be placed onto REHAU PE membrane followed by a 10mm dry flooring element (see diagram 1). This provides a clean solution without the introduction of any wet trades and can compensate for differences in floor height of up to 60mm.

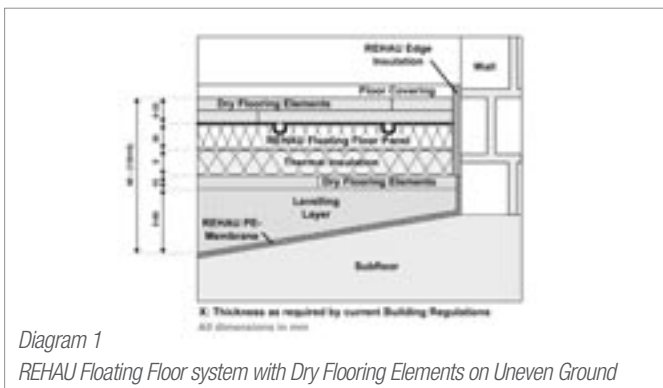

When installing the system onto a suspended timber floor, ensure the floor structure is solid enough to withstand the intended load without deflecting or flexing. Check the structural integrity of the floor and make any defects good (i.e screw down all loose floorboards). (See diagram 2).

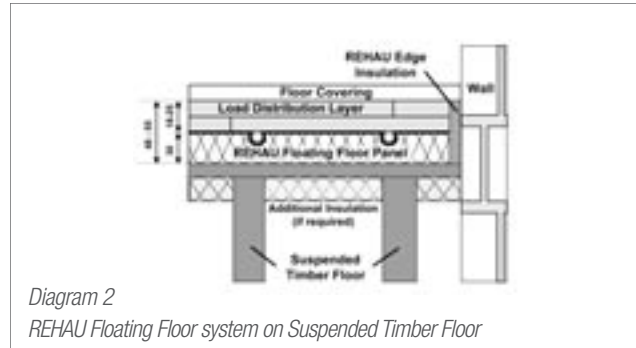

Distribution Layer

To distribute the intended loads uniformly across the Floating Floor panels, a distribution layer must be laid. For domestic applications this can be chipboard or plywood, for commercial applications it is recommended using 25mm Dry Flooring Elements, which are glued together at the joints to create a uniform floor (See flooring manufacturers guidelines). For commercial applications with higher traffic loads, a second layer of 10mm Dry Flooring Elements can be bonded on top (see flooring manufacturers guidelines). (See diagram 3 for orientation of layers).

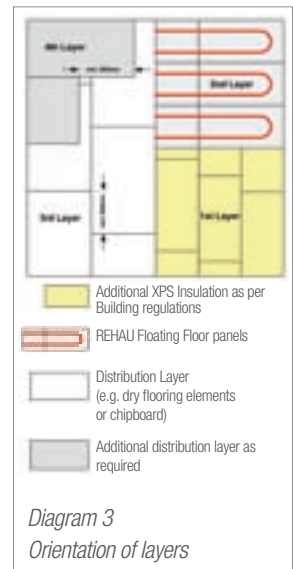

Additional Insulation

To meet current Building Regulations, some installations may require additional insulation. Extra insulation panels can be laid underneath the floating floor panels at a 90° angle. However, it is important to check that the insulation is suitable for the intended point loads (see diagram 3 for orientation of layers).

REHAU Routing Tool

The REHAU routing tool allows easy and quick customisation of panels. It is mains operated and features a hot blade specially shaped to cut the correct groove into the Floating Floor panels. Its size makes it the ideal solution for tight pipe bends and where grooves have to be cut close to a wall or corners.



5. FLOATING FLOOR SYSTEM INSTALLATION INSTRUCTIONS

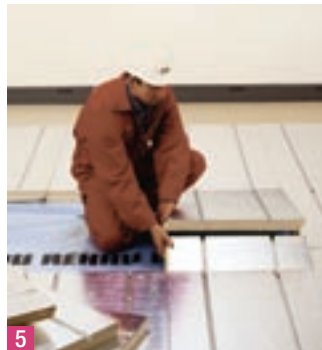
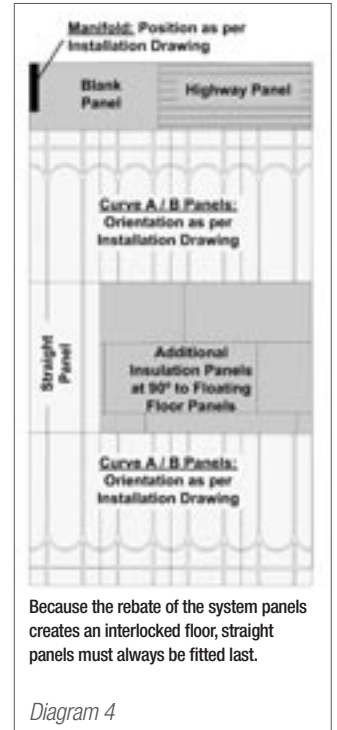
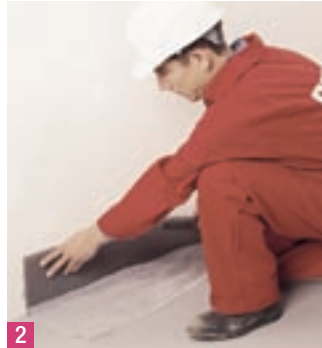

Step 1 - Make sure site requirements for installing underfloor heating are met: rooms cleared, installation area dry, sealed to the elements, flat even floor, and surface free of irregularities.

Step 2 - REHAU edge insulation must be fitted if using Dry Flooring Elements. It is not required with chipboard or plywood flooring panels. However, using edge insulation can assist in eliminating sound bridging.

Fit REHAU edge insulation around the perimeter and internal walls, columns, drains and door frames ensuring a 50mm overlap at joints (insulation already comes with self adhesive tape on the back).

Step 3 - REHAU polyethylene membrane must be used if Dry Flooring Elements are being used on concrete as a substrate:

- The membranes overlap each other by 200mm and should be sealed
- The adhesive tape from the foil on the edge insulation is securely fixed to the membrane.

Step 4 - Lay additional insulation (if required) as follows:

- The longest side of the panel is laid at a 90° angle to the Floating Floor panels
- Stagger the joints as in a brick wall
- Insulation boards are butted tightly up against each other.

Step 5 - Lay REHAU Floating Floor Panels ensuring the following (see diagram 4):

- Always lay one insulation panel or highway panel underneath the manifold
- Use highway panels along the shortest wall for all connecting lengths
- **Always lay curved A & B first**
- Next lay straight panels. Trim as required using the REHAU insulation cutter.

Step 6 - Mark on all Floating Floor panels where additional grooves are required (see diagram 3 for details). Then route the grooves into the panels using the REHAU routing tool or an industrial router with suitable vacuum cleaner.

5. FLOATING FLOOR SYSTEM INSTALLATION INSTRUCTIONS



7



8



9

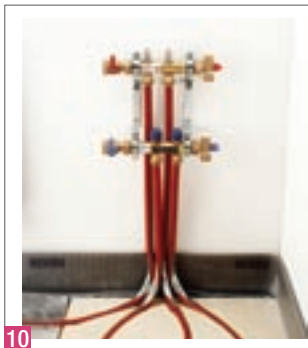

10

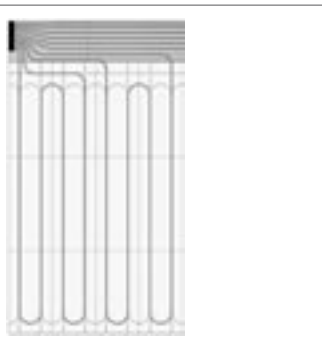

11



Floor distribution layout

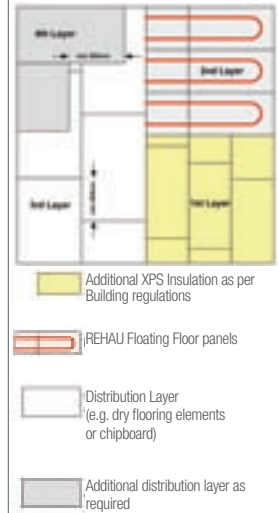

12

Step 7 - Fix manifold to the wall or into the cabinet. Fit the pipe bend former in the corner where pipe enters the Floating Floor panel, allowing for enough pipe to reach the manifold. Alternatively, corrugated sleeve with retaining rail can be used. Connect REHAU RAUTHERM pipe to the manifold using REHAU pipe connecting unions.

Step 8 - Push pipe into the grooves of the Floating Floor panels following the single meander pattern. Use a sharp knife to cut the foil over the bends (or the REHAU insulation cutter).

Step 9 - Cut the return pipe ensuring there is enough pipe to connect to the manifold. Ensure the pipe forms a tight bend to the wall. Fit the pipe bend former or

corrugated sleeve on to the pipe where it exits the Floating Floor and connect to the manifold using REHAU pipe connecting unions.

Step 10 - Install remaining circuits as detailed in steps 7 to 9.

Note: A pressure test must be carried out first before continuing with steps 11 & 12.

Step 11 - Fit load distribution layer at 90° to the Floating Floor panels and follow manufacturer's guidelines.

Step 12 - Lay the final floor covering making sure the surface of the distribution layer has been prepared according to manufacturer's guidelines.



IMPORTANT
Always fit pipe bend formers



IMPORTANT
Each layer is orientated at 90° to layer below

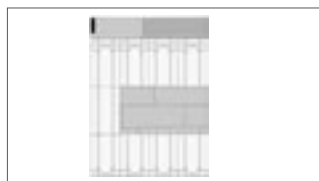

IMPORTANT
Position Curve Panels first before fitting Straight Panels

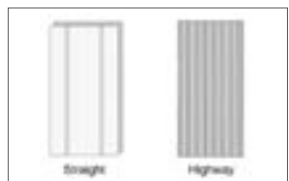

IMPORTANT
Watch out for rebate on system panels

Component Selection Table

Components	16mm RAUTHERM Pipe Art. No. 136430	20mm RAUTHERM Pipe Art. No. 136450	Average Quantity
Straight Panel Art. No. 234439	N	Y	1.33 panels per m ²
Curve A Panel Art. No. 234440	N	Y	1.33 panels per m ²
Curve B Panel Art. No. 234450	N	Y	1.33 panels per m ²
Highway Panel Art. No. 234459	N	Y	1.33 panels per m ²
Blank Panel Art. No. 234619	N	Y	1.33 panels per m ²
Pipe Bend Former Art. No. 258798	N	Y	2 piece per circuit
Edge Insulation Art. No. 264411	N	Y	Length of perimeter
Polyethylene Membrane Art. No. 256054	N	Y	1.3m per m ²
Floor Insulation Cutter Art. No. 249632	N	Y	-
Routing Tool Art. No. 249682	N	Y	-
Corrugated Sleeve Art. No. 137150	N	Y	1m per manifold port

Technical Data

	Panel Type				
	Straight	Curve A	Curve B	Highway	Blank
REHAU Art. No.	234439	234440	234450	234459	234619
Dimensions in mm (Length x Width x Thickness)	1250x600x30	1250x600x30	1250x600x30	1250x600x30	1250x600x30
Foil faced	Y	Y	Y	N	N
Thermal conductivity	0.029 W/mK	0.029 W/mK	0.029 W/mK	0.029 W/mK	0.029 W/mK
Compression strength	300 kPa	300 kPa	300 kPa	300 kPa	300 kPa
Density	> 30kg/m ³	> 30kg/m ³	> 30kg/m ³	> 30kg/m ³	> 30kg/m ³
Fire class	Euroclass E	Euroclass E	Euroclass E	Euroclass E	Euroclass E
Grade classification to BS EN 13164	Designation code to EN 13164 TI - CS (10/Y) 300 - CC (2/1.5/50) 110 WL (Y) 0.7 - WD (V) 3 - FT2 - DS (TH) - DLT (2) 5				

Typical Floor Structure

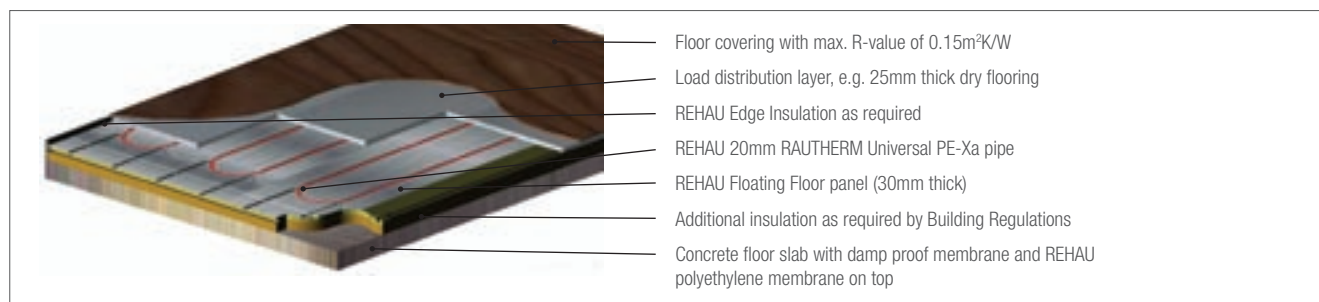

5. SPRUNG FLOOR SYSTEM



The REHAU Sprung Floor system is used for impact resilient floors, which are predominantly used for physical activities, such as sports halls, dance studios, leisure centres, squash courts, etc. To achieve the best performance from the system, it is recommended to use a high quality flooring system, e.g. Junckers BluBat Sports Floor System (batten size 48x50mm).

When installing the REHAU Sprung Floor system in a room which is required for a multitude of uses, the installation must be carefully assessed as the required design temperatures of 20°C to 21°C can result in extended response times.

The underfloor heating pipes are not fixed in any way to the sprung floor structure. This ensures the unique performance characteristics of the sprung floor are preserved. It also means that the benefits of a REHAU underfloor heating system can be enjoyed without having to compromise on the sprung floor effects.

Each underfloor heating circuit is laid in the double meander pattern with all heating circuits installed parallel to each other. This simplifies the hydraulic fine-tuning of the complete system during commissioning.

The REHAU Sprung Floor system utilises a matrix of REHAU RAUTHERM Universal pipe 20mm x 1.9mm within an air chamber formed between the floor surface, the flooring joists and the insulation layer beneath the pipes.

Due to the construction of the REHAU Sprung Floor system, it is possible to use it with other raised sports floor systems.

Due to the heat transfer of the REHAU Sprung Floor system, standard design software such as HT2000 cannot be used.



If new era type floor are to be used please contact sales office.

5. SPRUNG FLOOR SYSTEM

COMPONENT DESCRIPTION

RAUFIX Rail

The RAUFIX rail is manufactured from Polypropylene and its unique pipe clip design makes it ideal for the 20mm REHAU RAUTHERM Universal pipe.

REHAU also offer another pipe clipping rail, the Railfix system, which can also be used (see page 38).

The function of the rail is to secure the underfloor heating circuits in the planned pattern.

RAUFIX rails are supplied in 1m lengths and must be cut down to fit between the joists of the sprung floor. The rails should be spaced at 400mm centres.

Staples

To secure the RAUFIX rails to the insulation, 40mm staples should be pushed in through the rail at alternating angles. The staples should also be used to fix the pipe close to where it passes through the notched joists.

Insulation

To achieve the best performance a minimum of 25mm thick high performance insulation is required beneath the pipes. To meet current Building Regulations some installations may require extra insulation.



Some sports floor systems are limited in height, e.g. Junckers BluBat Sports Floor System - 48mm total), which means that only 25mm thick insulation can be installed above the concrete substrate. In such circumstances, any additional thermal insulation required must be fitted underneath the substrate.

Floor Preparation

The substrate must be sufficiently flat and smooth. Typical requirements require no gaps of more than 3mm under a 3m straight edge.

(Please refer to flooring manufacturer's guidelines).

A moisture barrier is installed to prevent moisture rising into the wood structure when the underfloor heating is in operation. (See flooring manufacturer's guidelines for exact specification).

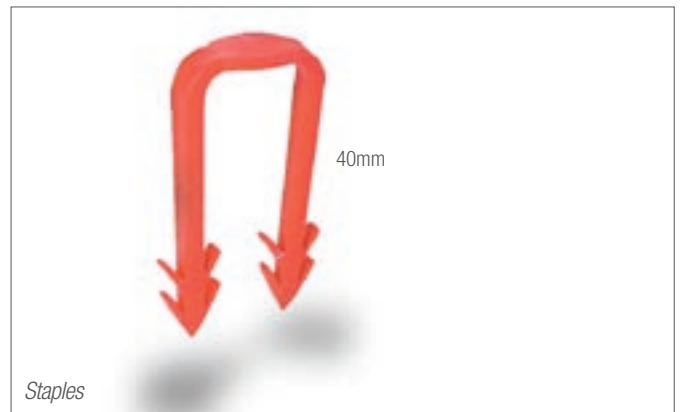

5. SPRUNG FLOOR SYSTEM

INSTALLATION INSTRUCTIONS

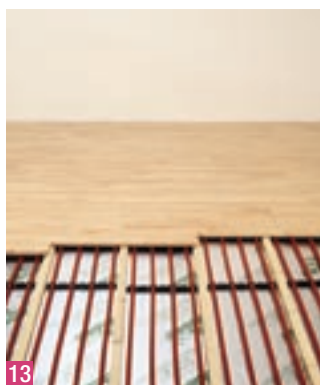
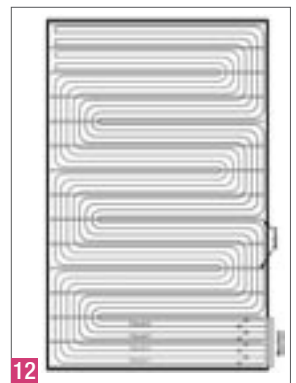
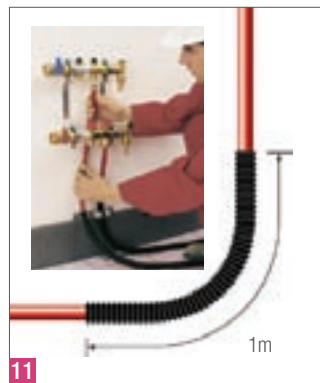
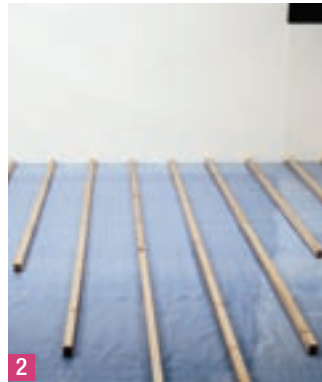
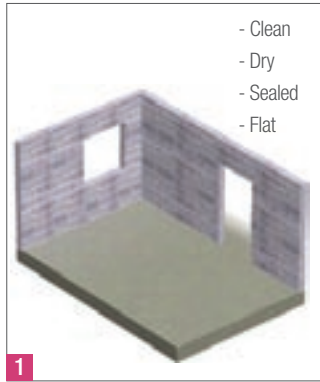

i Installation shown for BLUBAT floor systems only. For other floor systems please contact the sales office.

Step 1 - Make sure site requirements for installing underfloor heating are met: space cleared, installation area dry, sealed to elements, flat even floor and a surface free of irregularities. In addition, check all requirements specified by the flooring manufacturer are also met. These typically include specific humidity levels and maximum residual moisture contents for concrete (or screed) subfloors and wooden based subfloors.

Step 2 - The moisture barrier and battens should be laid as per installation instructions issued by the flooring manufacturer. As standard moisture barriers are overlapped by 200mm and battens spaced at 411mm centres with a reduced spacing close to the walls. Batten joints must not be even but staggered as much as possible. (See flooring manufacturers guidelines).

Step 3 - Lay insulation between the battens (BluBat only) ensuring the following:

- Insulation boards are trimmed to fit between the battens
- All boards are butted tightly up against each other and to the battens
- The specified spacing of battens remain unchanged.

Step 4 - Notch the battens ensuring that:

- You have identified the correct locations on the installation drawing
- No notch is directly below a tongue and groove joint on the floorboards and their fixings. The notches should be spaced to the width of the floor boards
- All notches are sufficiently deep to prevent the pipe from touching the floor boards
- Every notch is lined with a thin polyethylene foil which can be wrapped over the pipe.

Step 5 - Fix RAUFIX rails to the insulation using at least 2 red staples per rail. Rails must be laid at 0.4m centres and about 0.5m from the first notch.

Step 6 - Fix manifold to wall or into cabinet and fix retaining rail underneath. Please refer to section 3 of this guide for further details.

Step 7 - Cut a short piece of corrugated sleeve (at least 1m long) and slide it over the pipe end. The sleeve is to protect the pipe when it passes through the wall or floor into the sports hall.

Step 8 - Connect the REHAU RAUTHERM Universal pipe to the manifold using REHAU pipe connecting unions.

Step 9 - Start laying the circuit by simply “snapping” the pipe into the RAUFIX rails. Circuits are laid in the double meander pattern as per the underfloor heating installation drawing.

Step 10 - Where the pipe passes through a notch ensure the pipe is laid with as little twist as possible (light bulb shape). Secure the pipe with additional red staples on both sides of the notch and fold the PE lining over the pipe.

Step 11 - Before connecting the return to the manifold, slide on another 1m long corrugated sleeve.

Step 12 - Install remaining circuits in the same way as detailed in steps 7 to 11.

Step 13 - Lay the floor boards according to the instructions of the flooring manufacturer.

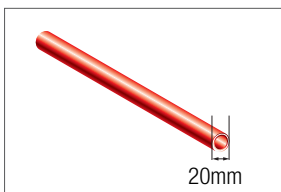

IMPORTANT
Use 20mm pipe only!



IMPORTANT
Pipe bends are laid in light bulb shape

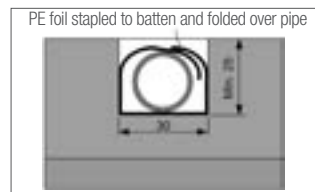

IMPORTANT
Notches are deep enough and lined

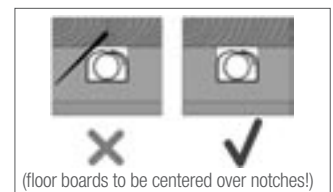

IMPORTANT
All tongue & groove joints and portanails must be clear of notches

Component Selection Table

Components	16mm RAUTHERM Pipe Art. No. 136430	20mm RAUTHERM Pipe Art. No. 136450	Average Quantity
RAUFIX Rail Art. No. 240241	N	Y	1.5m per m ² floor
Railfix Rail Art. No. 259258	N	Y	1.5m per m ² floor
RAUFIX Staples Art. No. 268118, 40mm	N	Y	8 pieces per m ² floor
Polyethylene Membrane Art. No. 256054	N	Y	1.3m per m ² floor

Technical Data

	RAUFIX Rail Art. No. 240241	Railfix Rail Art. No. 259258	RAUFIX Staple Art. No. 268118	Polyethylene Membrane Art. No. 256054
Size	1000mm x 50mm x 40mm	50mm x 20mm	40mm x 20mm	1200mm x 0.2mm x 100m
Material	Polypropylene (PP)	PVC		Polyethylene (PE)
Weight	0.224kg	0.35kg/m	0.001kg	29kg / 100m
Colour	Black	Grey	Red	Clear

Typical Floor Structure

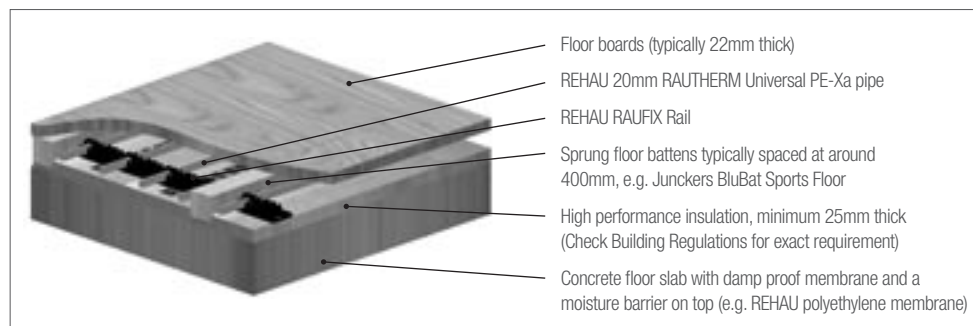

6. SPECIAL APPLICATIONS

TABLE OF CONTENTS

REHAU Industrial Floor Heating.	pg58
REHAU industrial manifold	pg58
REHAU cable ties	pg58
REHAU RAUFIX rail	pg58
REHAU RAILFIX rail	pg58
REHAU retaining pins	pg58
REHAU pipe bend bracket	pg58
Assembly.	pg59
Planning	pg59

6. SPECIAL APPLICATIONS

REHAU INDUSTRIAL FLOOR HEATING



Components

- REHAU industrial manifold
- REHAU cable tie
- REHAU RAUFIX rail
- REHAU RAILFIX rail
- REHAU retaining pins.

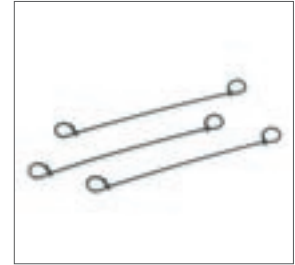
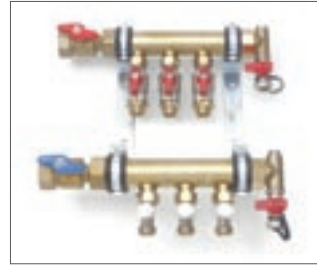

REHAU industrial floor heating

- Easy and quick assembly
- Comfortably temperature-controlled floor surface
- Even temperature profile
- Minimal air speeds
- Optimum room arrangement flexibility
- Low operating temperatures
- Suitable for heat pump and solar power systems
- No maintenance costs.

Pipe dimensions

- RAUTHERM S 20 x 2.0mm
- RAUTHERM S 25 x 2.3mm.

System accessories

- REHAU pipe bend bracket.

Description

REHAU industrial floor heating is assembled in a parallel formation in the concrete floor panel. In the standard solution, the heating pipes are secured to the reinforcement elements with REHAU cable ties and connected to the REHAU industrial manifold.

REHAU industrial manifold

Manifold and collector are made of brass pipe with bleed valve and KFE valve. Cut-off of each heating circuit is guaranteed via a ball valve (or thermostat valve) in the flow and a fine-control valve (for hydraulic balancing of each heating circuit) in the return. Assembled on robust, galvanised, sound insulated brackets.

REHAU cable ties

For protective attachment of the heating pipes to the reinforcement elements of the floor panel.

Material	Polyamide
Temperature resistance	-40 to +105 °C



REHAU RAUFIX rail

Clamping rail made of polypropylene for the attachment of the RAUTHERM S pipe 20 x 2.0mm. Moulded barbs on the bottom. Can be extended on both sides due to an integrated snap connection.

Possible installation spacing	5cm and multiples thereof
Pipe lift	5mm

REHAU RAILFIX rail

Clamping rail made of PVC for attachment of the RAUTHERM S pipe 25 x 2.3mm.

Possible installation spacing	10cm and multiples thereof
Pipe lift	10mm

REHAU retaining pins

For attachment of the RAUFIX or RAILFIX rail at the insulation.

Colour	Red
---------------	-----

REHAU pipe bend bracket

For precise redirection of the heating pipe when connecting to the manifold.

Material	Polyamide
Colour	Black

6. SPECIAL APPLICATIONS

ASSEMBLY

Early agreement among the installers / designer involved is necessary for trouble-free installation!

- Install Floor panel and cover with film
- Assemble bedding layers and lower reinforcement grids (wire grates from the construction company)
- If a special “pipes in the neutral zone” construction is planned, assemble special baskets or frames
- Install heating pipes according to plan and connect to the manifold.
- Flush, fill and de-aerate heating circuits
- Perform pressure test
- Complete upper reinforcement
- Complete concreting of floor bay.



We recommend that the heating installer is present during concreting.

Planning

Floor panel

REHAU industrial floor heating can be installed in floors made of steel reinforced concrete, steel fibre-reinforced concrete and vacuum concrete (with cement as binding agent). Exceptions to this include all asphalt concrete types (cold - and hot installed). The use of the industrial hall, resulting traffic and usage loads do not influence the design of the REHAU industrial floor heating, rather only the static dimensioning of the floor bay. For this reason, designing of the concrete floor bay (taking the above mentioned stresses into account) and the quality of the surface and the groundwater level may only be handled by a structural engineer. The structural engineer also determines the position of the heating pipes in the floor bay and the expansion joint arrangement.

- For floor bays reinforced with steel grids, the lower reinforcement can generally be used as a pipe carrier, i.e. the heating pipes are directly attached to the grids of the lower reinforcement level with REHAU cable ties. Only then are the spacing baskets and upper reinforcement grids assembled. This standard solution (Diagram 1) has a host of advantages:
 - Easy assembly
 - No additional costs for pipe carrier elements
 - Higher “drilling flexibility”
- If the structural engineer prefers installation of the heating pipes in the neutral position, we must return to the special solution (Diagram 2). The heating pipes are assembled on the crossbars of

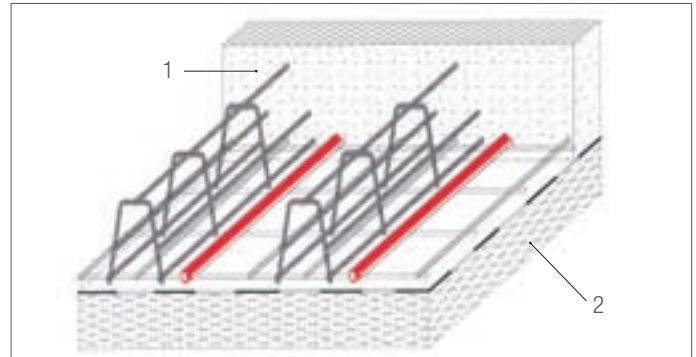

Diagram 1 - Floor panel reinforced with steel grids; standard construction heating pipes assembled to the lower reinforcement grid. 1 Concrete plate 2 Foundation

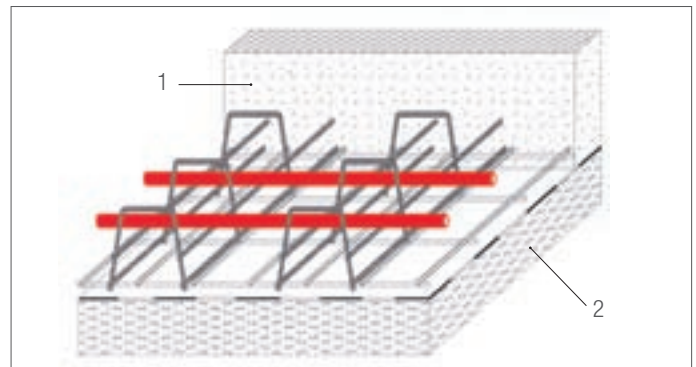

Diagram 2 - Floor panel reinforced with steel grids; special construction heating pipes assembled at the centre of the plate. 1 Concrete plate 2 Foundation

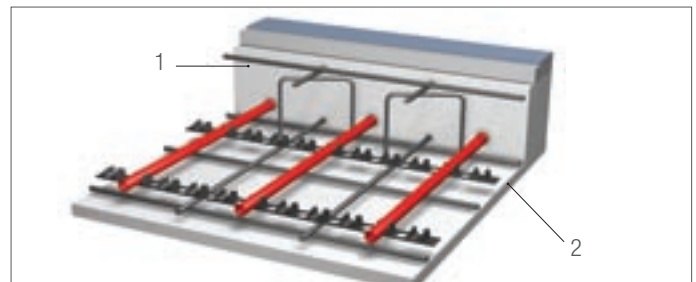

Diagram 3 - Floor panel reinforced with steel fibres; special construction heating pipes assembled to the clamping rails. 1 Concrete plate 2 Foundation

the spacing baskets ordered as special items. These also act as spacers for the upper reinforcement grids installed afterwards.

- In steel fibre-reinforced concrete plates, the classic reinforcement of the plates (steel grids, steel bars) is replaced by the addition of steel fibres. To guarantee that the planned installation spacing of the heating pipes results, additional attachment elements must be used. The easiest and repeatedly tested solution is the REHAU RAUFIX rail for the RAUTHERM S 20 x 2.0 pipes and the REHAU RAILFIX rail for the RAUTHERM S 25 x 2.3mm pipes (Diagram 3). If desired, the clamping rails can be replaced by a backer board.

6. SPECIAL APPLICATIONS

PLANNING

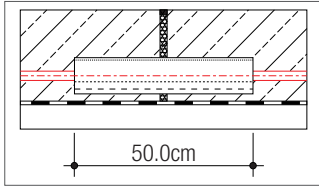

Un-doweled expansion joint with protection via 100 % insulating tube

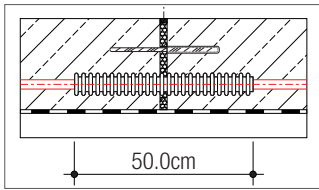

Doweled expansion joint with REHAU protective sleeve

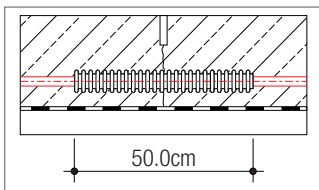

Dummy joint, pressed joint with REHAU protective sleeve

Separation and floating layers

To prevent mixing water penetrating into the insulation layer or in the unbound bearing layer, they are covered with a separation layer (e.g. one layer of polyethylene film). To avoid friction between the floor panel and the bearing layer, so-called floating layers are used (e.g. two layers of polyethylene film). Normally, the separation and floating layers are installed by the construction company.

Heating insulation

All building insulation to comply with current Building Regulations.

Building water-proofing

The building water-proofing (against ground moisture, water not under pressure or water under pressure) must be planned and executed according to DIN 18195 or other local standards and regulations. Normally, the building water-proofing is installed by the construction company.

Joint arrangement

To absorb movements (e.g. heat-related expansion) of the floor panel and neutralise internal tensions, expansion and dummy joints are used. If a floor panel is cemented in several sections (depending on the capacity of the mobile concrete factory), so-called pressed joints arise.

- The expansion joints separate the floor panel from other construction elements (e.g. walls, foundations) and separate larger floor panels into smaller fields.

- The dummy joints prevent uncontrolled shifting of the floor panel.

The expansion joints can be constructed as "doweled" (freedom of movement only possible on dowel level) or "un-doweled" (freedom of movement possible in all directions). The type and position of the joints are determined by the responsible structural engineer.



Expansion Joints

Heating pipes which cross expansion joints must be protected with sleeve.

Installation types

The classic snail-shaped installation type is generally not used here. Better options for adaptation (i.e. no collisions) to the course of the support baskets or support frames are offered by the meander-type installation. The drop in temperature (on the heating level and on the surface) can be compensated for via parallel installation of the flow and return lines. The heating circuits can be separated or installed in parallel, as required. Running several heating circuits in parallel, forms a zone with an even surface temperature. At the same time, complex pressure balancing at the manifold is avoided, since the length of the heating circuits laid in this way is almost the same.

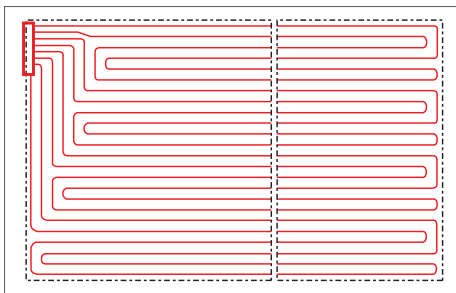

Heating circuits separate

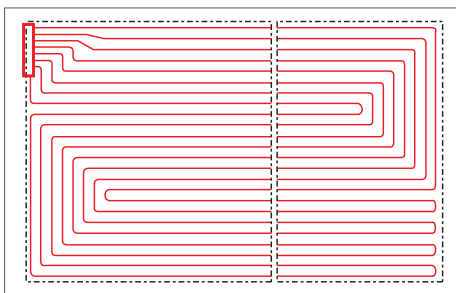

Heating circuits run in parallel (zone formation)

Design

The performance diagrams are used to determine the operating parameters of the industrial floor heating. The diagrams are calculated according to DIN 4725. The arrangement of any necessary perimeter zones according to the sketch shown below must be conducted differently than with non-industrial floor heating.

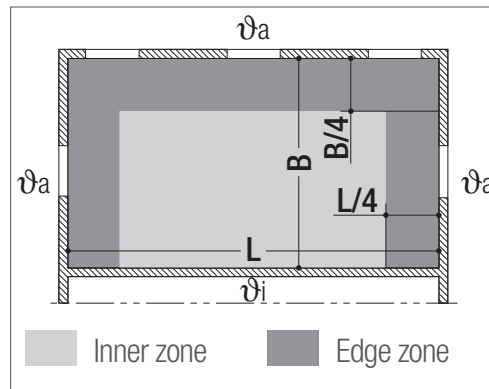

Zone arrangement

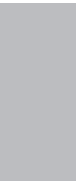

7. COMPRESSION SLEEVE JOINTS

TABLE OF CONTENTS

Compression Sleeve Joint	pg64
Jointing Tools	pg64
Jointing Instructions	pg65

7. COMPRESSION SLEEVE JOINTS



RAUTOOL M1

Compression Sleeve Joint

The REHAU compression sleeve joint is a non-detachable joint which is in accordance with BS 1264 - 4. The joints can be concealed (e.g. within screed or concrete) without an inspection shaft as long as they are clearly marked on the installation drawings.

The REHAU underfloor heating connection system relies on the “memory effect” which is the recovery behaviour of the RAUTHERM universal pipe.

The bore of the ‘cold’ RAUTHERM pipe is expanded using an expander tool. The fittings are then placed into each end of the pipe and jointed using the REHAU compression sleeving tool. This jointing technique requires one specific fitting for each RAUTHERM pipe size (16mm and 20mm) and jointing should only be carried out with a REHAU compression sleeving tool.

REHAU offer a wide range of robust compression sleeve tools to provide the installer with the right tool for every installation.

IMPORTANT

Compression sleeve joints which will be covered in concrete or screed must be protected from corrosion in accordance with DIN 18560 e.g. wrapping them in PVC-U tape.

Jointing Tools

RAUTOOL M1:

- Manual jointing tool with two double clamping jaws: Sizes 16-20mm, 25-32mm
- Expansion tool with four expansion heads
- Pipe cutter
- Pipe gripper
- Allen key.



RAUTOOL H1

RAUTOOL H1:

- Hydraulic tool with two double clamping jaws. The tool is operated by a foot/hand pump. Sizes 16-20mm, 25-32mm
- Expansion tool with four expansion heads
- Pipe cutter
- Pipe gripper
- Allen key.

Electric and automated hydraulic tools are also available on request from REHAU. Please contact your local REHAU sales office for details.

7. COMPRESSION SLEEVE JOINTS

INSTALLATION INSTRUCTIONS

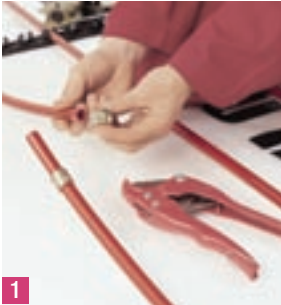

1



2



3

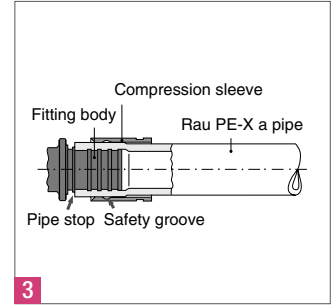

3



3



4



4



5

Step 1 - Cut both pipe ends with the pipe cutter (supplied with the tool set). Once the cutting blade has touched the pipe it must be cut (any non visible micro fractures could seriously reduce the burst strength of the pipe).

Slide a compression sleeve onto each pipe end. The inner chamfer of the fitting must be facing towards the cut end of the pipe.

Step 2 - Expand the pipe end with the correct sized expander heads (see expander head for size). Expand the pipe, then rotate the expander heads by 20-25°. Repeat the expansion process to achieve a uniform expanded bore head.

i
If the expander head is missing a segment (for example due to mechanical damage) then no further connection should be made with this head, as one-sided expansions will lead to leaks.

Step 3 - Push the expanded pipe ends onto each end of the fitting up to the pre set stop (last raised rib).

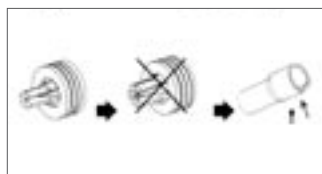

IMPORTANT
Don't use damaged expander heads

Slide the compression sleeve to the collar of the fitting using the jointing tool (use the correct size jaws).

When using RAUTOOL M1, make sure the release slider is in the top most position before the jointing tool is positioned over the fitting.

Step 4 - To release the manual RAUTOOL M1, slide the release slider down and to the side.

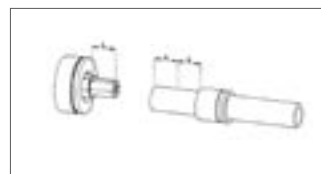

IMPORTANT
Always slide on sleeve to double the length of the expander head

To release the hydraulic RAUTOOL H1 simply press the black release button next to the pump.

Step 5 - If the pipework is to be covered by screed then the brass fittings must be protected by tape.

Step 6 - According to BS EN 1264, all underfloor heating joints must be clearly marked on the installation drawing.

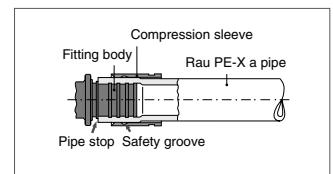

IMPORTANT
Always push the pipe onto the fitting to pre stop position

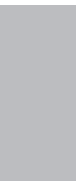

8. SCREEDS AND FLOOR COVERINGS

TABLE OF CONTENTS

General Structural Pre-conditions	pg68
Screeds	pg68
Anhydride (flow) screeds	pg68
Screed curing	pg68
Expansion Joints	pg69
Layout	pg69
Floor coverings.	pg69
Floor Coverings	pg70

8. SCREEDS AND FLOOR COVERINGS

GENERAL STRUCTURAL PRE-CONDITIONS

In general, site requirements according to BS 1264 - 4 apply. They include:

- The roof is already on, windows and doors have been installed and the walls have been plastered
- Wall openings, cavities, wall and ceiling breakthroughs have been created for connecting and installing the manifold, cabinet and connecting lengths
- The sub-floor is secure, swept clean and sufficiently flat and even to comply with BS 8204 class SR2 (a 3m straight edge on the floor leaves no gaps larger than 5mm).

In addition to the above requirements, the following should also be ensured:

- Electricity and water connections must be available for jointing and pressure testing
- A damp proof floor membrane must be installed



Please note that the REHAU membrane is NOT a damp proof membrane.

- A detailed drawing of the exact configuration of the heating circuits and required pipe lengths per circuit is available

- A current valid plan for expansion joints is available for any joints that may be required.

Screeds

- The time taken from laying the pipes, pressure testing and screeding should be minimised. This avoids any damage to the pipe from foot traffic. Please also refer to BS 1264 - 4
- The relevant manufacturer's guidelines for screeding should be followed



Ensure that the selected screed is suitable for underfloor heating.

- The recommended cement / sand screed height over the pipe is at least 50mm.

The following points should be clarified at the planning stage with the architect, structural engineer, heating engineer, screed layer and installer of the floor covering:

- Type and thickness of the screed and floor coverings
- Area of the screed, layout and shape of the expansion joints
- The number of joints at which the residual humidity is to be measured.

Anhydride (flow) Screeds

The following measures should be taken when using an anhydride (flow) screed:

- Only select an anhydride (flow) screed that has been approved for underfloor heating use by a screed manufacturer
- All membrane joints must overlap by at least 80mm or be taped to avoid leaks as specified by BS 1264 - 4
- Long-term operating temperatures must not exceed the limits specified by the screed manufacturer (usually 55°C, refer to BS 1264 - 4)
- For areas of high humidity (bathrooms, saunas, pool areas, etc), the use of an anhydride (flow) screed is limited (please refer to the screed manufacturer). In such cases the manufacturers guidelines should be closely followed.

Screed Curing

Once the screed has been laid, foot traffic must be limited, in accordance with the screed manufacturer's guidelines. Usually, no foot traffic is permitted for the first three days and no site traffic for the first twelve days.

All anhydride (flow) and cement screeds must go through a heat cycle before any floor coverings can be laid. Please follow the screed manufacturer's guidelines and those set out by BS 1264 - 4. It is usual that the heat cycles are carried out:

- Cement screeds - after a minimum 21 days
- Anhydride (flow) screeds - after a minimum 7 days.

After the heat cycle, floor coverings must not be laid until the screed has fully cooled down. Please ensure that while cooling down the screed is not exposed to draughts.



The underfloor heating system must NOT be used to accelerate the curing of the screed.

The company responsible for the final floor covering e.g. carpet, wood, vinyl must establish that the moisture content within the screed is suitable.

8. SCREEDS AND FLOOR COVERINGS

EXPANSION JOINTS

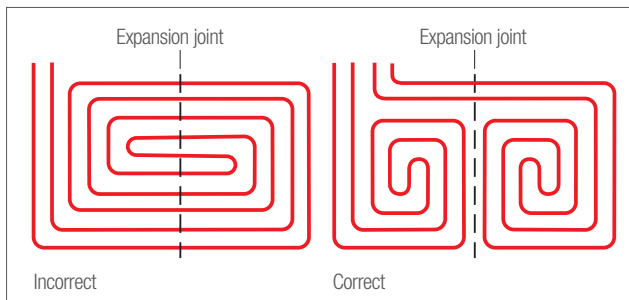

Layout

- BS 8204 guidelines and requirements should be adhered to
- One joint is always required between a heated screed slab and an unheated screed slab
- In addition to expansion joint around the perimeter created by the edge insulation, heated screeds require joints if one of the following apply:

1. The screed surface is in excess of 40m².
2. The side lengths are in excess of 8m.
3. The ratio A/B of both sides A and B is greater than half.
4. There are construction joints in the base.

- All planned joints must be marked on the architects drawing and then submitted to the underfloor heating installer / designer as part of their works schedule
- Manifold positions and underfloor heating circuits should be planned and positioned to avoid routing through expansion joints (see diagram on the left)
- Connecting lengths may cross through expansion joints, but must be protected using the REHAU expansion joint profile and the REHAU corrugated sleeve, extending to at least 25cm either side of the joint.



Incorrect expansion joints are the most common cause of damaged floor screeds.

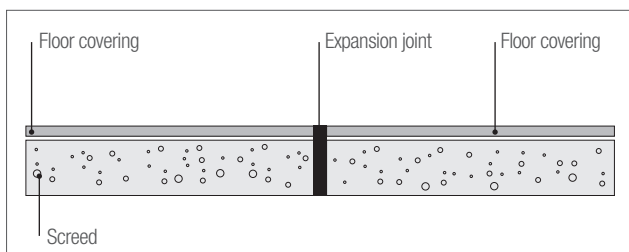

Floor Coverings

Floor coverings when used in conjunction with expansions joints should be discussed and agreed at the planning stage with the company responsible for laying the final floor covering.

Expansion joints should continue through the screed slab and should be level with the upper most part of the final floor covering e.g. hard coverings (ceramic and wood) and soft coverings (i.e. plastic and textile). This will reduce the potential rippling and cracking of the floor covering.

8. SCREEDS AND FLOOR COVERINGS

FLOOR COVERINGS

When installing an underfloor heating system the final floor covering must be considered and calculated for resistance to thermal conductivity at the design stage. Specifiers should check that any materials used for the floor covering adhesives are suitable and can tolerate the floor surface temperatures.

A wide range of materials can be used from wood to stone. But the most efficient floor material is that which has a low thermal resistance and can easily conduct heat from the floor.

In principle any type of floor covering can be used as long as its thermal properties are incorporated within the underfloor heating design. However, it is recommended that the maximum R-value of the floor covering does not exceed 0.15m²K/W or a carpet tog value of 1.5.

Once the screed has cured and has undergone its first heat cycle, minor micro cracking may occur within the screed. This does NOT affect the performance of the screed. However, final floor coverings must NOT be laid until the floor has cooled down completely as joints and grouting within the floor covering could be damaged.

The table below shows the most common types of materials used for final floor coverings and their resistance to thermal conductivity.

Typical Floor Coverings

Type	Cross Section	Thickness	Thermal conductivity	Resistance to thermal conductivity	Thickness of the overall structure
		d mm	λ W/mk	R_{λ} m ² K/W	d_{wd} mm
Textile floor covering		10	0.07	max 0.15	10
Parquet adhesive compound		8 2	0.2 0.2	0.04 <u>0.01</u> 0.05	10
Plastic covering, e.g. Vinyl		5	0.23	0.022	5
Ceramic floor tiles thin bed of mortar		10 2	1.0 1.4	0.01 <u>0.001</u> 0.011	12
Ceramic floor tiles mortar bed		10 10	1.0 1.4	0.01 <u>0.007</u> 0.017	20
Natural or cast stone tiles: marble mortar bed		15 10	3.5 1.4	0.004 <u>0.007</u> 0.011	25

9. COMMISSIONING

TABLE OF CONTENTS

Commissioning Procedure	pg72
Pre-commissioning checks and documentation	pg72
Pressure test certification.	pg73
Initial system warm up.	pg74
Helpful advice	pg74
System Balancing	pg75
Pre-requisites	pg75
Procedure.	pg75
Pressure Testing	pg77
Equipment	pg77
Preparation	pg77
Setup	pg77
Flushing the circuit	pg78
Pressure testing	pg78
Pressure testing in sub-zero conditions	pg78
Pressure Test Certificate	pg79
UFH System Warm up Certificate	pg80

9. COMMISSIONING

COMMISSIONING PROCEDURE

According to CIBSE (Chartered Institute of Building Service Engineers), the definition of commissioning is 'The advancement of an installation from static completion to working order to specified requirements'.

Correct commissioning is essential to obtain the optimum operating settings of the underfloor heating system as set out by the system designer.

Commissioning will require the co-operation and participation of all parties involved in the design and installation of the underfloor heating and control system. It is important for each party to set aside sufficient time and resources needed for installation and any pre-commissioning checks required during the project.

Commissioning will be one of the last major tasks. The correct checks and documentation will reduce the time and workload needed.

On completion the system is handed to the client / end user, they should be supplied the REHAU End Users Guide. This manual will contain all the relevant project operation and maintenance information on the underfloor heating hydraulic and electrical control systems.

Pre-commissioning Checks and Documentation

System Designer

- Must provide the underfloor heating Installer with all the relevant design documentation. This will be the design data sheets and CAD drawings (if required) detailing circuit layout and manifold positioning.
- If the project includes the Diffusion Plate system for a suspended floor, then he must provide copies of the REHAU Excel application.

- The Control System Designer must provide the underfloor heating Installer and REHAU sales office with the wiring diagrams based on the control system being used.



It is the responsibilities of the UFH installer to commission or to arrange the commissioning of the UFH system.

Underfloor Heating Installer

- Each circuit flow and return connection from the manifold should be identified on a manifold schedule prior to screeding
- A manifold schedule should consist of the following (see example below):
 - Manifold reference number
 - Number of circuits on the manifold
 - Which area/room each circuit supplies
 - Confirmation of temperature control
 - Required flow temperature
 - Required flow rate
 - Balancing information
 - Number of turns required on the manifold balancing valve. This will be found on the project design data sheet. (See page 75 on balancing underfloor heating system circuits).
- Copies of the manifold schedule should be given to:
 - Installer
 - Client
 - Main M & E consultant
 - Main M & E contractor
 - Electrical/Control contractor
 - Clerk of works
 - Commissioning engineer.

Manifold Schedule

Manifold Ref	Room No	Ti °C	Q Watt	Room Area m ²	Heated Area m ²	Perimeter Area m ²	Flow Temperature °C	Flow Rate l/min	Valve Turns

Pressure Test Certification

On completion of laying the underfloor heating circuits, each manifold should be pressure tested. For instructions please refer to page 79.

The underfloor heating Installer and Main Mechanical Contractor must be on site for the pressure testing. This is necessary for the pressure test certificate and will also alleviate unnecessary delays in resolving any problems if they should occur during this period.

The test pressure should be noted on the certificate at the start and at the end of the procedure. If the pressure after 24hrs has complied to REHAU's recommendations (see pressure test instructions page 77) then both parties are required to sign the certificate.



Once this is agreed the responsibility of the underfloor heating system is handed over to the main contractor.

After the screed has been laid, the system must remain at the test pressure for a minimum of 21 days (BS 1264 - 4: 2001) or that stated in writing by the screed Contractor/Manufacturer.

A sample of the test certificate is on page 79.

The underfloor heating Installer is responsible for completing the pressure test certificate.

The underfloor heating system will be handed over still filled with water. It is essential that the system is not exposed to freezing conditions. In the event of freezing the M&E Contractor must ensure one of the following:

- The complete system including all concealed circuits are protected from freezing; or
- The complete system is drained and all circuits are cleared of water using compressed air; or
- A suitable anti-freeze is present at the manufacturers recommended concentration throughout the system.

Instructions on the controls commissioning procedures are available in the Intelligent Control Installer Guide.

9. COMMISSIONING

COMMISSIONING PROCEDURE

Initial System Warm up

Electrical Wiring

As part of the REHAU underfloor heating system, the underfloor heating Installer should provide all the necessary wiring control diagrams and manifold schedules to all parties involved. This will also allow the Electrician / Control Engineer to inspect the wiring arrangement at the manifold.

Once the power is connected, the control wiring can be checked. There is no need for the circuits and other hydraulic components of the underfloor heating system to be operational. However it is recommended to fill the circuits with water to prevent dry-cycling of pumps.

All connections and operational sequences can be confirmed using diagnostic equipment.

Warm up certification

(See page 80 for template).

The main system boiler, pumps and circulating pump (e.g. compact mixer) should be operational before the initial warm up period. Both the boiler flow and return must be connected to the manifolds.

For standard cement screeds, the initial warm up should take place no earlier than 21 days after the screed has been laid. For anhydride (flow) screeds the recommended curing time before initial warm up is a minimum of 7 days. Please refer to the screed manufacturer.

1. The start up temperature on the flow header to the manifolds should be limited and maintained between 20°C and 25°C for 3 days.
2. The design flow temperature must then be maintained for 4 days without the system going into set-back mode.
3. The system then should be allowed to cool down.

Helpful Advice

During the initial warm up ensure that:

- The balancing of the underfloor heating system is carried out during the 4-day period at the design flow temperature. (See page 69)
- Each room thermostat is checked so that it operates the correct number of actuators and they are controlling the correct zones
- Each control room thermostat or external time switch (Intelligent Controls) is programmed with the customer specific timed 'ON' and set-back settings and that the temperature reduction mode (set-back) is verified. (See commissioning - Intelligent Controls Installer Guide)
- The flow temperatures to the underfloor heating system is confirmed / recorded as stated on the design data sheets
- The underfloor heating Installer clearly demonstrates and explains the following to the client / end user:
 - The main electrical system isolation switch
 - The control operating sequence
 - Programming the control thermostat Intelligent Control
 - The individual thermostat features such as:
 - setting the temperature set points
 - setting the set-back temperature
 - Operation of the mode selection valves
 - System isolation valves (for emergencies)
 - The position of the system temperature / pressure gauges
- The warm up procedure should not be interrupted by the operation of the room thermostats.

9. COMMISSIONING

SYSTEM BALANCING

Pre-Requisites

- The main system boiler and pumps are fully operational
- The main system flow and return are connected to the manifold
- The compact mixer or other circulating pump is fully operational
- All the underfloor heating circuit flow and balancing valves are fully open
- No thermal actuators are fitted
- The main manifold balancing valve (main system boiler) is fully open
- The system is fully vented after the compact mixer or other circulating pump has been fitted. (For compact mixer use the air vent situated above the temperature gauge)
- There is a copy of the latest underfloor heating design sheet available - detailing flow rates and balancing valve settings.

Procedure

The design data sheet lists all the underfloor heating circuit settings for each balancing valve in the form of 360° 'turns'.

- 0 = Slightly open
- 1 = One full turn 360°
- 2.5 = Fully open flow meter
- 5 = Fully open

See Design Data for Diffusion Plate System (Diagram 1) and Design Data for Screed Floor System (Diagram 2 - on page 76).

The balancing valves can be set using the REHAU radiator key supplied with the manifold.

Standard Manifold - Balancing Valves

The balancing valves are located on the flow header (top header with black protective caps).

Flow Meter Manifold - Balancing Valves

The balancing valves are integrated into the isolating valves located on the return header (lower header with blue protective caps). The flow rates can then be checked against the values given on the design data sheet.



1 As with all heating systems, once fully operational further fine-tuning may be required.

Project	Test		
Date	Revision:		
Manifold Reference	Test	Type:	
		1 Standard 2 Flow	
Room / Circuit Number			
Room area per UFH circuit	20.00	5.00	12.00
Heated area per UFH circuit	20.00	5.00	11.00
Heat demand per UFH circuit	1200	250	750
W/m ²	60	60	68
Shortfalls	0	0	0
Type of plate:	Double	Double	Double
No. plates	31	8	18
Pipe Length Art. No. 136430			
Plates	110	28	61
Connection length (m)	10	2	2
Total pipe length	130	32	65
No. of circuits	1	1	1
Flow rate per circuit	0.0287	0.0060	0.0179
Pa/m	0.07	0.00	0.03
Δ Pipe	8.59	0.15	1.91
Δ Valves	0.73	0.01	0.07
Total pressure drop	9.32	0.16	1.98
Valve Turns (5 fully open, 0 closed)	6.00	0.32	1.04

Diagram 1. Design Data for Diffusion Plate System

Installation Data

Room No.	Zone	Designation	Heat. Area (m ²)	PS (mm)	No. Hig. Ccts.	Pipe Length (m)	Valve Set		Flow Rate (l/min)	No Heat Area.	Ins Idx	Ind. Con.
							T1 Turns	T2 Turns				
Manifold 1 REHAU Manifold Cabinet - UP (flush)												
1	Oz	Study	8.2	200	1	44.9	3.85	3.85	1.7	0.2	2	Y
2	Oz	Kitchen	5.0	200	1	35.1	0.00	0.00	0.4	2.4	2	Y
3a	sPz	Living room	6.1	100	1	70.0	2.15	2.15	1.2		2	Y
3b	Oz		11.6	300	1	47.6	0.62	0.62	0.6		2	N
3c	Oz		11.6	300	1	47.6	0.62	0.62	0.6		2	N
4	Oz	Bedroom	13.1	300	1	53.7	0.68	.068	0.6		2	Y
5	Oz	Bathroom	6.1	150	1	48.9	5.00	5.00	1.7	0.5	2	Y
6	Oz	Nursery	13.5	300	1	53.1	0.69	0.69	0.6		2	Y

Diagram 2. Design Data for Screed Floor System

Key:

Ind. Con.	= Individual Stat. control	PZ	= Peripheral Zone
Ins. Idx	= Insulation Index		(s = separate PZ Circuit)
	(1 = SD/N EPS-25mm)		(u = Combined/Upstream of Oz)
	(2 = SD/N EPS-50mm)		(c = Combined/Closer Spaced)
	(3 = HD/N EPS-25mm)		(than Occupied Zone, OZ)
	(4 = HD/N EPS-50mm)	PS	= Pipe Spacing
NoHeat Area.	= Floor Area not Covered by UFH	T1	= Circuit Balancing Valve
No.Htg Ccts	= Number of Heating Circuits		Setting for a single Manifold
OZ	= Occupied Zone		(0 = Fully Closed, 5 = Fully Open)
		T2	= System Balancing Valve Sett.

9. COMMISSIONING

PRESSURE TESTING

Pressure testing is carried out prior to screeding, to check that the underfloor heating system has no post installation damage to the pipework and that there are no blockages within the circuits. This is achieved by filling the circuit with water, pressure testing then finally flushing out.

IMPORTANT

For health and safety reasons, REHAU do not recommend that compressed air is used for pressure testing.

The pressure test should be witnessed and documented by the underfloor heating Installer and Main Contractor / Client.

The underfloor heating system should be pressure tested for 24 hours with an initial stable pressure of 6 bar. Due to the expansion properties of the REHAU RAUTHERM universal pipe under pressure, the final test pressure will be slightly lower than 6 bar and should settle at a range of 3.5 to 5 bar, dependant on conditions.

Pressure test results can be affected by ambient temperature.

Equipment

To complete the pressure testing sequence apart from access to a mains water supply the following will be required:

- 2 x 1/2" hose union
- 2 x 1/2" hosepipe of suitable length
- 1 x pressure test pump with 1/2" union nut connection hose
- 1 x air vent key (radiator key)
- 1 x 15m ballofix valve
- 1 x 1" BSP M1 plug
- 1 x 1" x 1/2" M1 bush
- 1 x 1" x 3/8" 10 bar pressure gauge
- 1 x 15mm copper tube 100mm long.

Preparation

- The manifold connected to the circuits, should be fitted with the quarter turn isolating valves, combined air vent and drain valve fittings

- The quarter turn isolation valves, combined air vent and drain valve fittings are of a pump union type with a flat face.

If a compact mixer is to be installed, it should be fitted as a second fix item. It must never be installed before the pressure test has been carried out.

Setup

1. Screw the 1" BSP **plug** into one of the isolation valves supplied with the manifold (using PTFE tape). The valve then is fitted to the **bottom** header on the manifold. Then screw the 1" x 1/2" BSP **bush** into the remaining isolation valve (using PTFE tape), then fit the valve to the **top** header on the manifold.

Do not fit the 1" BSP plug onto the top header.

Ensure that the fibre washers (supplied) are fitted between the valves and the manifold before tightening the union nuts. Both isolation valves should be in the 'closed' position.

2. Fit the combined air vents and drain valves to the top and bottom header on the manifold (opposite the isolation valves). Ensure the fibre washers are placed between the valve face and the manifold before tightening the union nuts.
3. Remove one compression nut from the ballofix valve and screw using PTFE tape into the 1" x 1/2" bush on the **top** header.
4. Attach the copper tube onto the ballofix valve. Ensure that the valve is in the 'closed' position.
5. Remove the air vent from the combined air vent and drain valve keeping it safe. This will be replaced at a later stage.
6. Fit the pressure gauge into the combined air vent and drain valve.
7. Using a jubilee clip connect one end of the hosepipe to the copper tube and the other to the mains water supply using one of the 1/2" hose unions. Turn the water on and ensure there are no leaks.
8. Fit the other hose union onto the 1/2" hosepipe and connect it to the air and drain valve on the bottom header. Place the other end of the hosepipe to a suitable discharge point, then open the drain valve.
9. Close all the circuits on the manifold by turning the blue screws on the bottom header and by removing the black caps and turning the balancing valves on the top header.



1

1 Flushing the circuit

Flushing the Circuit

1. Ensure that the isolating valve on the top header is in the 'open' position and that the drain valve on the bottom header on the manifold is also open. Open the ballofix valve to charge the top header on the manifold with the water at mains pressure.
2. On the top header of the manifold open the balancing valve on the first circuit. Next open the corresponding blue cap on the bottom header on the manifold. Water will then flow through the circuit and into the bottom header on the manifold.
3. Check the drain hosepipe to ensure that water is flowing through the circuit. Water should be allowed to flow through the circuit for at least 5 minutes to clear the circuit of air.
4. Once the water is running clear of bubbles, turn the blue cap to close the circuit valve. There is no need to close the balancing valve.
5. Repeat steps 2 - 4 for the remaining circuits.
6. Close the drain valve on the manifold and then the ballofix valve. Turn the water off and remove the hosepipe from the manifold using the compression nut on the ballofix valve.



2

2 Flushing the circuit

Pressure Testing

1. Fill the pressure test pump with water, close the pressure release valve on pump and depress the handle a few times. If the pump is working correctly water should flow through the connecting hose.
2. Connect the pressure test pump to the manifold using the 1/2" union nut on the hose to the thread on the ballofix valve.
3. Open all the circuit valves on the manifold (if required).
4. Open the ballofix valve and pressurise the system slightly, then vent the system of air using the air vent on the top header of the manifold.
5. Pressurise the system to 6 bar then close the ballofix valve and isolation valve. Ensure there are no leaks from the manifold connections.

This process may need to be repeated several times before the pressure within the system stabilises at 6 bar. This is due to the inherent flexible properties of PE-Xa.

6. When the pressure is stabilised remove the pressure pump. After the 24-hour test period the system should remain under pressure

Pressure Testing in Sub-Zero Conditions

When pressure testing in conditions where the temperature is below zero, the system will require anti-freeze solution during the filling and pressure testing procedure.

IMPORTANT

The anti-freeze solution should be prepared to the manufacturers instructions and then removed from the system before commissioning using compressed air. It is recommended that the system then be flushed through with water (see also BS EN 1264 - 4). The anti-freeze should then be disposed in accordance with relevant guidelines set out by the Health and Safety Executive Requirements and manufacturers guidelines.

To calculate the total manifold / pipework water quantity the REHAU RAUTHERM pipe has the following water quantity per meter run of pipework:

- 16mm dia.= 0.17 l/m
- 20mm dia.= 0.21 l/m.

Not only is it important to protect the circuits at sub-zero temperatures, but it is important to protect the manifold by using an insulating material e.g. glass fibre.

9. COMMISSIONING

PRESSURE TEST CERTIFICATE

1. Installation Data

Output of boiler: _____

Boiler manufacturer: _____

Exact location within building: _____

Max. operating pressure: _____

Max. operating temperature: _____

2. Pressure Test

Completed:

- a) Close isolating valve on return header of manifold
- b) Flush and fill each circuit individually one circuit after the other
- c) Vent manifold headers
- d) Pressurise to 6 bar
- e) Pressurise again after 2hrs (pipe expansion causes initial pressure loss)
- f) Test Period of 24 hours
- g) Pressure test is successful, if
 - there are no leaks within the circuits
 - pressure has not fallen by more than 0.1 bar per hour

Note:

Ensure that during the screeding process the maximum operating pressure is applied to quickly recognise leaks.

3. Confirmation

The Pressure Testing was carried out in accordance with BS EN 1264 PT. 4.
No leaks were detected and no component showed a permanent deformation.

Location	Date
M&E Contractor	Installer

IMPORTANT - Freezing Conditions:

As the system is handed over filled with water, the pipes will be damaged if they are exposed to freezing conditions. If there is any risk of freezing conditions before the system is in full operation, the M&E contractor must ensure that:

- The complete system including all concealed circuits is protected from freezing
- The complete system is drained and all circuits are cleared off water using compressed air
- A suitable anti-freeze is present at the manufacturer's recommended concentration throughout the system.

9. COMMISSIONING

UFH SYSTEM WARM UP CERTIFICATE

According to applicable standards, anhydride and cement screeds must be heated up once, before floor coverings can be installed. Cement screeds can only be heated up after the screeding process has been finished for at least 21 days. In case of anhydride screeds, please refer to the manufacturer's guidelines, however, a 7 day minimum curing period is common.

Any shorter curing times and/or modifications of the below given heating sequence (temperature, number and duration of heating steps) must be approved in writing by the screed manufacturer and / or the screeding company prior to commencing the initial heat up.

Project: _____

Installer: _____

Screeding Company: _____

REHAU Underfloor Heating System:

REHAU RAUTHERM Universal Pipe: _____ Outer Diameter: _____ Pipe Spacing: _____

Screed type: Cement Screed cm/inch thick (over insulation) Anhydride Screed cm/inch thick (over insulation)

Date of screeding: _____

Outside temperature at start of heat up: _____ °C

Room temperature at start of heat up: _____ °C

1. Set Flow temperature at start between 20° and 25°C and kept constant for 3 days Started on: _____ Completed on: _____

2. Maintain max. design flow temperature for at least 4 days without night set-back Started on: _____ Completed on: _____

4. System cooled down Started on: _____ Completed on: _____

In case of problems: Warm up stopped on: _____

Established causes: _____

Heat up and Cooling carried out without problems: Yes No

Architect/M&E contractor: _____ Place, Date _____ Signature _____

Installer: _____ Place, Date _____ Signature _____

Note:

After a successful completion of the warm up it is not guaranteed, that the screed has reached the required residual moisture level for the selected floor coverings. The installer of the floor coverings should therefore satisfy himself, that the screed is ready for the floor coverings.

10. FREQUENTLY ASKED QUESTIONS

TABLE OF CONTENTS

Insulation	pg82
Screed	pg82
Floor Coverings	pg82
Boilers.	pg83
Controls	pg83
Miscellaneous	pg83

Insulation

Do I need insulation and which type should be used?

Not only does an underfloor heating system require insulation for it to work effectively, floors must also be constructed to the current UK Building Regulations and any other additional requirements set by BS EN 1264 - 4, therefore insulation is regularly required.

Building regulations specify the required insulation on:

- Floor type (solid ground floor and suspended upper floors)
- Targeted U - value of the floor
- Floor perimeter to floor area ratio P/A
- Thermal conductivity of the insulation.

Solid floor in contact with the ground

For a standard 4 bedroom domestic house (8m x 8m floor area) with a ground bearing floor slab, 100mm of expanded polystyrene grade EPS 70 (thermal conductivity of at least 0.038W/m²K) will be sufficient to achieve a U- value of 0.25 as required by Part L of the UK Building Regulations. It will also satisfy the requirements of BS 1264 - 4 for an R - value of 1.25.

However, from one project to another the exact figures must be verified, as these will depend on the ratio between the exposed perimeter and floor area of the building.

Upper floors (not exposed)

The UK Building Regulations do not specify a required insulation for this type of floor.

However, BS EN 1264 - 4 requires an R - value of at least 0.75, which can be achieved with 25mm of expanded polystyrene grade EPS 70.

Screed

What type of screed should I use with underfloor heating?

There are no specific requirements for screeds when used with underfloor heating. However, the screed must be suitable for the floor loading purposes of the project. The Architect / Structural engineer should specify to what the screed should conform to.

For domestic applications a sand cement screed to BS 8204 is suitable and shouldn't require any further additives.

It is recommended that the screed depth is at least 75mm, this will allow for sufficient cover of the pipework.

Do anhydride (flow) screeds present any problems?

According to anhydride (flow) screed manufacturers the overall thickness of this type of screed can be substantially reduced, which will affect the level of coverage over the pipework. It is strongly recommended to consult the manufacturer for advice.

When using anhydride (flow) screeds with underfloor heating please ensure that all vapour barrier joints and EPS edge insulation skirt and overlaps are taped to prevent leaks seeping under the EPS insulation.

REHAU recommend using the REHAU Tacker system for anhydride (flow) screeds. If using the RAUFIX/Railfix system, it is important to fix the pipe return loops at three equally spaced positions between the fixing rails with fixing staples. This will prevent the pipe from floating out of position in the screed.

Anhydride (flow) screeds will not affect REHAU RAUTHERM universal pipe.

Floor Coverings

What is the best floor covering to use with underfloor heating?

The most effective floor covering for use with underfloor heating is ceramic or stone tiles due to the low thermal resistance and therefore gaining the optimum performance from the system.

What precautions should be taken when using tile floor coverings on underfloor heating?

When using tile floor coverings on underfloor heating they should be fixed directly onto the screed surface. It is important to use flexible fixing adhesive to avoid cracks in the tile surface. This is due to the differences in the co-efficient of expansion between the floor screed and tiles.

What about carpet coverings?

When using carpet and underlay the thermal resistivity should not exceed 0.15m²K/W (1.5 TOG), as this will reduce the heat output significantly.

What about timber floor coverings?

When using timber floor coverings, care should be taken to store the natural wood in the room with the UFH turned on, until the moisture content does not exceed 8%. This is necessary to reduce the effects of shrinkage.

Boilers

What type of boiler do I need?

Any type of boiler can be used with underfloor heating. However, if the flow temperature of the boiler exceeds that of the required flow temperature then appropriate measure must be taken to mix the hot water down to the required temperature. REHAU recommend using a condensing boiler due to the low flow and return temperatures within the system.

What fuel can I use?

Due to the low temperatures required by underfloor heating almost all types of fuel can be used e.g. Solar energy, ground heat source and electric.

What size boiler do I need?

The size of the boiler is determined by the underfloor heating design plus any other loading required such as domestic hot water, radiators etc. The design package used by REHAU gives the required heat input needed into the underfloor heating system. If the project is only heated by underfloor heating then the only other addition needed to achieve the required heat input would be the domestic hot water requirements.

For a domestic project the domestic hot water heat load is approximately 3 kW.

Guideline: for an approximation of the size of boiler required, the maximum output including downward heat losses can be calculated as:

- 115 W/m² for solid floors
- 80 W/m² for suspended.

Controls

How should underfloor heating be operated?

Underfloor heating is intended to be operational at all times during the heating season. However, this doesn't mean that the system operates continually in the same way. The system should use a night set-back facility as part of the control system to maximise the efficiency of the underfloor heating i.e. when the room / area is not in occupancy or at night.

The night set-back facility would reduce the heat being supplied to the floor screed and lower the temperature of the room to a pre-set point. The pre-set point for the night set-back mode should not be lower than 6°C below the set room temperature.

By limiting the temperature fall by 6°C the amount of heat then needed to raise the temperature again is minimum. If there is a severe cold spell and the room temperature falls below the 6°C set point then the boiler will automatically activate and maintain the room temperature at 6°C below the set point until the underfloor heating system ON time is activated.

Can the REHAU underfloor heating system be integrated with other system requirements?

Yes, the REHAU underfloor heating system can be integrated with other system requirements. However, for domestic and commercial applications it is recommended that the REHAU Intelligent Controls system is used. Please contact your local REHAU sales office for further details.

Can individual room temperatures be controlled?

By using room thermostats and circuit actuators on the distribution manifold each room temperature can be individually controlled.

Miscellaneous

What happens if the pipework is damaged after installation?

The damaged circuit should be identified and isolated. The damaged pipework should then be exposed and repaired using the REHAU straight couplings and compression sleeves. The circuit is then put back into operational mode and the floor surface is restored.

Do REHAU offer a warranty?

REHAU offer a ten year manufacturing warranty on the pipe and joints, which includes consequential damage. Using the REHAU straight couplings and compression sleeves. The circuit is then put back into operational mode and the floor surface is restored.

Our verbal and written application engineering advice is based upon experience and the best of our knowledge. However it is to be regarded as non-binding information. Working conditions and use under conditions for which the product was not intended and over which we have no influence exclude any claim resulting from our information. We recommend that a suitable check is made as to whether the REHAU product is suitable for the envisaged purpose. Application, use and processing of the products is carried out beyond the scope of our control and are therefore carried out exclusively at your own responsibility. If liability should still apply, then this is restricted, in the case of all damage, the value of the goods supplied by us and used by you. Our warranty applies to the consistent quality of our products as per our specification and in accordance with our general terms and conditions of delivery and payment. This document is protected by copyright. All rights based on this are reserved. No part of this publication may be translated, reproduced or transmitted in any form or by any similar means, electronic or mechanical, photocopying, recording or otherwise, or stored in a data retrieval system.

UK & IRELAND SALES OFFICES

For all large commercial projects, please contact our London Office

London	Slough	Birmingham	Manchester	Glasgow	Dublin
REHAU Ltd The Building Centre 26 Store Street London WC1E 7BT	Units 5 J & K Langley Business Centre Station Road Langley Slough SL3 8DS	Tameside Drive Holford Way Witton Birmingham B6 7AY	Brinell Drive Irlam Manchester M44 5BL	Phoenix House Phoenix Crescent Strathclyde Business Park Bellshill, North Lanarkshire ML4 3NJ	9 St. Johns Court Business Park Swords Road Santry Dublin 9
Tel: (0207) 580 6155 Fax: (0207) 307 8595	Tel: (01753) 588500 Fax: (01753) 588501	Tel: (0121) 344 2300 Fax: (0121) 344 2301	Tel: (0161) 777 7400 Fax: (0161) 777 7401	Tel: (01698) 503700 Fax: (01698) 503701	Tel: 00353 (0)1 8165020 Fax: 00353 (0)1 8165021